

***Pioneer***

**AUDIO/VIDEO  
MULTI-CHANNEL RECEIVER**

**VSX-D498**

**Operating Instructions**

Thank you for buying this Pioneer product. Please read through these operating instructions so you will know how to operate your model properly. After you have finished reading the instructions, put them away in a safe place for future reference.

In some countries or regions, the shape of the power plug and power outlet may sometimes differ from that shown in the explanatory drawings. However the method of connecting and operating the unit is the same.

## IMPORTANT NOTICE

**The serial number for this equipment is located on the rear panel. Please write this serial number on your enclosed warranty card and keep it in a secure area. This is for your security.**

**WARNING: TO PREVENT FIRE OR SHOCK HAZARD, DO NOT EXPOSE THIS APPLIANCE TO RAIN OR MOISTURE.**

THE POWER SWITCH IS SECONDARY CONNECTED AND THEREFORE DOES NOT SEPARATE THE UNIT FROM MAINS POWER IN THE STANDBY POSITION.

## IMPORTANT



The lightning flash with arrowhead symbol, within an equilateral triangle, is intended to alert the user to the presence of uninsulated "dangerous voltage" within the product's enclosure that may be of sufficient magnitude to constitute a risk of electric shock to persons.



CAUTION:  
TO PREVENT THE RISK OF ELECTRIC SHOCK, DO NOT REMOVE COVER (OR BACK). NO USER-SERVICEABLE PARTS INSIDE. REFER SERVICING TO QUALIFIED SERVICE PERSONNEL.



The exclamation point within an equilateral triangle is intended to alert the user to the presence of important operating and maintenance (servicing) instructions in the literature accompanying the appliance.

This equipment has been tested and found to comply with the limits for a Class B digital device, pursuant to Part 15 of the FCC Rules. These limits are designed to provide reasonable protection against harmful interference in a residential installation. This equipment generates, uses, and can radiate radio frequency energy and, if not installed and used in accordance with the instructions, may cause harmful interference to radio communications. However, there is no guarantee that interference will not occur in a particular installation. If this equipment does cause harmful interference to radio or television reception, which can be determined by turning the equipment off and on, the user is encouraged to try to correct the interference by one or more of the following measures:

- Reorient or relocate the receiving antenna.
- Increase the separation between the equipment and receiver.
- Connect the equipment into an outlet on a circuit different from that to which the receiver is connected.
- Consult the dealer or an experienced radio/TV technician for help.

# IMPORTANT SAFETY INSTRUCTIONS

**READ INSTRUCTIONS** — All the safety and operating instructions should be read before the product is operated.

**RETAIN INSTRUCTIONS** — The safety and operating instructions should be retained for future reference.

**HEED WARNINGS** — All warnings on the product and in the operating instructions should be adhered to.

**FOLLOW INSTRUCTIONS** — All operating and use instructions should be followed.

**CLEANING** — Unplug this product from the wall outlet before cleaning. The product should be cleaned only with a polishing cloth or a soft dry cloth. Never clean with furniture wax, benzine, insecticides or other volatile liquids since they may corrode the cabinet.

**ATTACHMENTS** — Do not use attachments not recommended by the product manufacturer as they may cause hazards.

**WATER AND MOISTURE** — Do not use this product near water — for example, near a bathtub, wash bowl, kitchen sink, or laundry tub; in a wet basement; or near a swimming pool; and the like.

**ACCESSORIES** — Do not place this product on an unstable cart, stand, tripod, bracket, or table. The product may fall, causing serious injury to a child or adult, and serious damage to the product. Use only with a cart, stand, tripod, bracket, or table recommended by the manufacturer, or sold with the product. Any mounting of the product should follow the manufacturer's instructions, and should use a mounting accessory recommended by the manufacturer.

**CART** — A product and cart combination should be moved with care. Quick stops, excessive force, and uneven surfaces may cause the product and cart combination to overturn.



**VENTILATION** — Slots and openings in the cabinet are provided for ventilation and to ensure reliable operation of the product and to protect it from overheating, and these openings must not be blocked or covered. The openings should never be blocked by placing the product on a bed, sofa, rug, or other similar surface. This product should not be placed in a built-in installation such as a bookcase or rack unless proper ventilation is provided or the manufacturer's instructions have been adhered to.

**POWER SOURCES** — This product should be operated only from the type of power source indicated on the marking label. If you are not sure of the type of power supply to your home, consult your product dealer or local power company.

**LOCATION** — The appliance should be installed in a stable location.

**NONUSE PERIODS** — The power cord of the appliance should be unplugged from the outlet when left unused for a long period of time.

## GROUNDING OR POLARIZATION

- If this product is equipped with a polarized alternating current line plug (a plug having one blade wider than the other), it will fit into the outlet only one way. This is a safety feature. If you are unable to insert the plug fully into the outlet, try reversing the plug. If the plug should still fail to fit, contact your electrician to replace your obsolete outlet. Do not defeat the safety purpose of the polarized plug.
- If this product is equipped with a three-wire grounding type plug, a plug having a third (grounding) pin, it will only fit into a grounding type power outlet. This is a safety feature. If you are unable to insert the plug into the outlet, contact your electrician to replace your obsolete outlet. Do not defeat the safety purpose of the grounding type plug.

**POWER-CORD PROTECTION** — Power-supply cords should be routed so that they are not likely to be walked on or pinched by items placed upon or against them, paying particular attention to cords at plugs, convenience receptacles, and the point where they exit from the product.

**OUTDOOR ANTENNA GROUNDING** — If an outside antenna or cable system is connected to the product, be sure the antenna or cable system is grounded so as to provide some protection against voltage surges and built-up static charges. Article 810 of the National Electrical Code, ANSI/NFPA 70, provides information with regard to proper grounding of the mast and supporting structure, grounding of the lead-in wire to an antenna discharge unit, size of grounding conductors, location of antenna-discharge unit, connection to grounding electrodes, and requirements for the grounding electrode. See Figure A.

**LIGHTNING** — For added protection for this product during a lightning storm, or when it is left unattended and unused for long periods of time, unplug it from the wall outlet and disconnect the antenna or cable system. This will prevent damage to the product due to lightning and power-line surges.

**POWER LINES** — An outside antenna system should not be located in the vicinity of overhead power lines or other electric light or power circuits, or where it can fall into such power lines or circuits. When installing an outside antenna system, extreme care should be taken to keep from touching such power lines or circuits as contact with them might be fatal.

**OVERLOADING** — Do not overload wall outlets, extension cords, or integral convenience receptacles as this can result in a risk of fire or electric shock.

**OBJECT AND LIQUID ENTRY** — Never push objects of any kind into this product through openings as they may touch dangerous voltage points or short-out parts that could result in a fire or electric shock. Never spill liquid of any kind on the product.

**SERVICING** — Do not attempt to service this product yourself as opening or removing covers may expose you to dangerous voltage or other hazards. Refer all servicing to qualified service personnel.

**DAMAGE REQUIRING SERVICE** — Unplug this product from the wall outlet and refer servicing to qualified service personnel under the following conditions:

- When the power-supply cord or plug is damaged.
- If liquid has been spilled, or objects have fallen into the product.
- If the product has been exposed to rain or water.
- If the product does not operate normally by following the operating instructions. Adjust only those controls that are covered by the operating instructions as an improper adjustment of other controls may result in damage and will often require extensive work by a qualified technician to restore the product to its normal operation.
- If the product has been dropped or damaged in any way.
- When the product exhibits a distinct change in performance — this indicates a need for service.

**REPLACEMENT PARTS** — When replacement parts are required, be sure the service technician has used replacement parts specified by the manufacturer or have the same characteristics as the original part. Unauthorized substitutions may result in fire, electric shock, or other hazards.

**SAFETY CHECK** — Upon completion of any service or repairs to this product, ask the service technician to perform safety checks to determine that the product is in proper operating condition.

**WALL OR CEILING MOUNTING** — The product should not be mounted to a wall or ceiling.

**HEAT** — The product should be situated away from heat sources such as radiators, heat registers, stoves, or other products (including amplifiers) that produce heat.

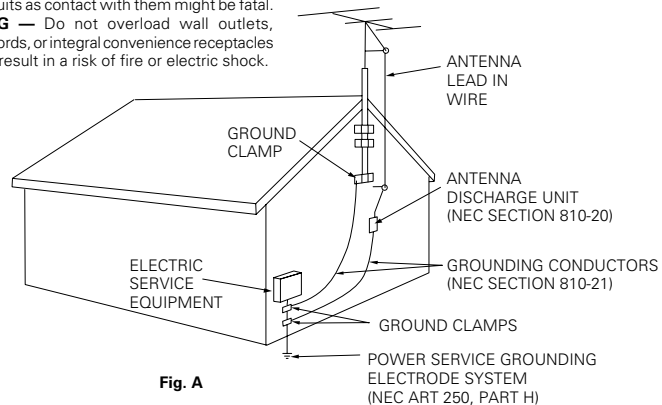

Fig. A

NEC — NATIONAL ELECTRICAL CODE

## Information to User

Alteration or modifications carried out without appropriate authorization may invalidate the user's right to operate the equipment.

# Features

## Dolby Digital and Dolby Pro Logic

No need to worry about program formats! When playing Dolby Digital or Dolby Surround software in the  (Dolby) Surround mode, decoding switches automatically according to the input signal. All you have to do is sit back and enjoy! (When connecting a DVD/LD player or LD player using the AC-3 RF output, a commercially available RF demodulator (RFD-1) is required.)

*Manufactured under license from Dolby Laboratories. "Dolby", "AC-3", "Pro Logic", " and double-D symbol are trademarks of Dolby Laboratories. Confidential Unpublished Works. © 1992 - 1997 Dolby Laboratories, Inc. All rights reserved.*

## Various Surround Effects (DSP)

The DSP (Digital Signal Processing) surround mode allows you to transform your living room into six different sonic environments when listening to music or watching movies.

## Midnight Listening Mode

When late night hours or other factors require that the volume be kept low, the surround effects may tend to become less than satisfactory. When the midnight listening mode is on, you can enjoy the effects of quality surround sound even at low volumes.

## 5.1 Channel Input

By connecting components equipped with 5.1 channel output to the DVD 5.1 channel input on this unit, you can enjoy 5.1 channel surround sound. Connections can be made to a DVD player, Multi channel decoder equipped with 5.1 channel analog output jacks.

## 5 Channels of Independent Amplification

This receiver incorporates 5 independent 80 watt power amplifiers which enable high quality playback of Dolby Digital surround sound. This construction provides improved linearity and accurate reproduction of each channel for true high fidelity reproduction from even the most demanding Dolby Digital program sources.

## Energy-saving Design

This unit is designed to use minimal electricity when power is switched OFF (during Standby). Regarding the value of the power consumption in standby mode, refer to "Specifications" on page 46.

<b>Introductory Information .....</b>	<b>6</b>
Checking the Supplied Accessories .....	6
How to Use This Manual .....	6
Power Connection (AC OUTLET) .....	6
Preparing the Remote Control .....	6
Receiver Installation .....	7
When Making Cable Connections .....	7
<b>Connections .....</b>	<b>8</b>
Antennas .....	8
Audio Components Connections .....	9
Video Components Connections .....	10
Digital Connections .....	11
DVD 5.1 Channel Connection .....	12
Speakers .....	13
<b>Preparations .....</b>	<b>15</b>
Setting Up for Surround Sound .....	15
<b>Names of Parts and Basic Operations .....</b>	<b>21</b>
Display .....	21
Remote Control .....	22
Front Panel .....	23
<b>Sound Modes .....</b>	<b>25</b>
Switching ANALOG/DIGITAL Signal Input .....	26
Playback .....	27
Playing Sources with Dolby Digital Sound .....	28
Selecting a Sound Mode .....	29
DVD 5.1ch input playback .....	30
Listening in MIDNIGHT Listening Mode .....	30
Adjusting Bass and Treble Frequencies (Tone Control) .....	31
<b>Tuner Operations .....</b>	<b>32</b>
Automatic and Manual Tuning .....	32
Direct Tuning .....	33
Memorizing Frequently Tuned Stations .....	34
Recalling the Memorized Stations .....	35
<b>Other Operations .....</b>	<b>36</b>
Recording from Audio Components .....	36
Recording from Video Components .....	37
Remote Controlling Other PIONEER Components .....	38
<b>Additional Information .....</b>	<b>43</b>
Dolby Digital .....	43
Troubleshooting .....	44
Specifications .....	46

# Introductory Information

## Checking the Supplied Accessories

Please check that you have received all of the following accessories with the receiver.



FM wire antenna



AM loop antenna

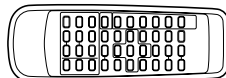

Remote control unit

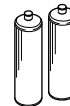

"AA" IEC R6P batteries x 2

## How to Use This Manual

This manual is divided into two main sections :

### SET UP

This section explains how to make the necessary connections from the receiver to your other audio and video components. Receiver operations described later in this section under the heading "Preparations" enable you to set up and customize your home entertainment center.

### OPERATION

This section provides complete information about operation of the receiver and supplied remote control.

The following marks and symbols are used throughout this manual:



Provides additional information, precautions, and advice.



Indicates a blinking button, indicator, or display.



Indicates a steadily lit button, indicator, or display.

## Power connection (AC OUTLET)

### [SWITCHED 100 W (0.8 A) MAX]

Switching this receiver on or putting it in standby also switches components connected to the receiver's AC OUTLET jacks on and off. When connecting components to the AC OUTLET jacks, leave the power switch of the connected components in the ON position. Total power consumption of connected components should not exceed 100W (0.8 A).

### CAUTION!

- To avoid malfunction, overheating, and possible fire risk, do not connect high-wattage appliances such as blow dryers and irons to the AC OUTLET jacks.
- Do not connect a monitor or TV set.  
Even if the power consumption of the TV or monitor is within the acceptable limits, when monitors or TV sets are switched on, they consume a large amount of power and may exceed the capacity of this receiver.

## Preparing the Remote Control

### Loading the batteries

AA dry cell batteries (( "AA" IEC R6P) × 2)

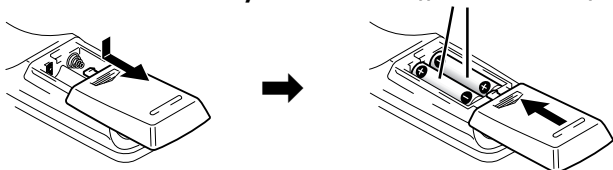

When you notice a decrease in the operating range of the remote control, replace all batteries with new ones.

### CAUTION!

Incorrect use of batteries may result in such hazards as leakage and bursting. Observe the following precautions.

- Never use new and old batteries together.
- Insert the plus and minus sides of the batteries properly according to the marks in the battery case.
- Batteries with the same shape may have different voltages. Do not use different batteries together.

## Operating range of remote control unit

Point the remote control toward the remote sensor  on the front panel of this unit to operate. The remote control unit will operate the receiver for up to a distance of 23 feet (7 m) within 30° angle on each side of the sensor of the remote sensor as illustrated below.

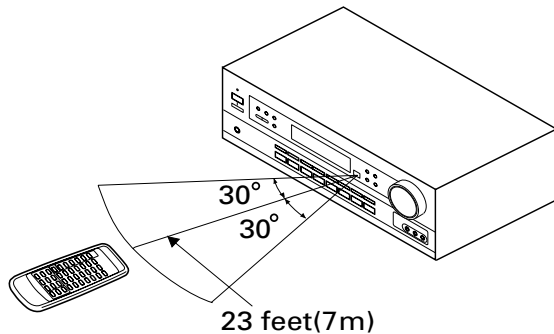

- memo** Remote control may not function properly if :
- There are obstacles between the remote control and the remote sensor.
  - Direct sunlight or fluorescent light is shining onto the remote sensor.
  - The receiver is located near a device emitting infrared rays.
  - Operated simultaneously with another remote control which uses infrared rays.

## Operating other PIONEER components

Connecting an optional control cord allows you to operate other PIONEER components simply by pointing the receiver's remote control at the remote sensor on the front panel of the receiver. The receiver then sends the remote control signals to the other devices via the CONTROL OUT terminal.

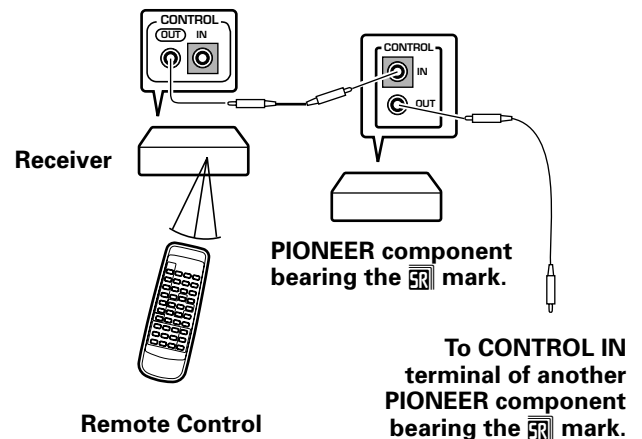

- memo** You can also control PIONEER components (and those made by other manufacturers) by pointing the receiver's remote control directly at the respective component. This type of operation does not require control cords.

## Receiver Installation

- Do not place objects directly on top of this unit. It will prevent proper heat dispersal.
- When installing in a rack, etc., be sure to leave more than 8 inches of space above the receiver.

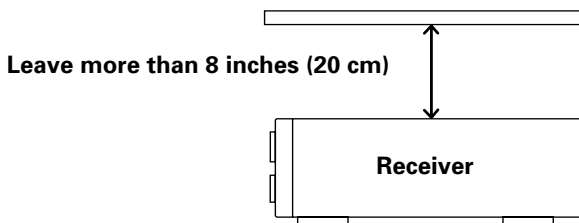

- memo** It is recommended that you place the receiver to the left of your cassette and/or video decks. This will prevent noise caused by leakage flux from the transformer in the receiver. If you experience noise during playback of your cassette and/or video decks, move them farther away from the receiver.

## When Making Cable Connections

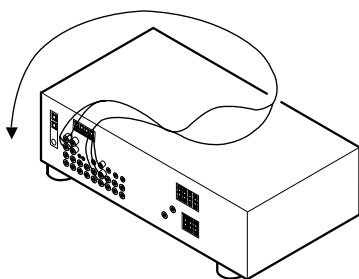

Be careful not to arrange cables in a manner that bends the cables over the top of this unit as shown in the illustration. If the cables are brought over this unit, the magnetic field produced by the transformers in this unit may cause a humming noise to come from the speakers.

## Antennas

FM wire antenna

Connect the FM wire antenna and fully extend (for best reception, attach horizontally along a window frame, etc.).

AM loop antenna

(See below)

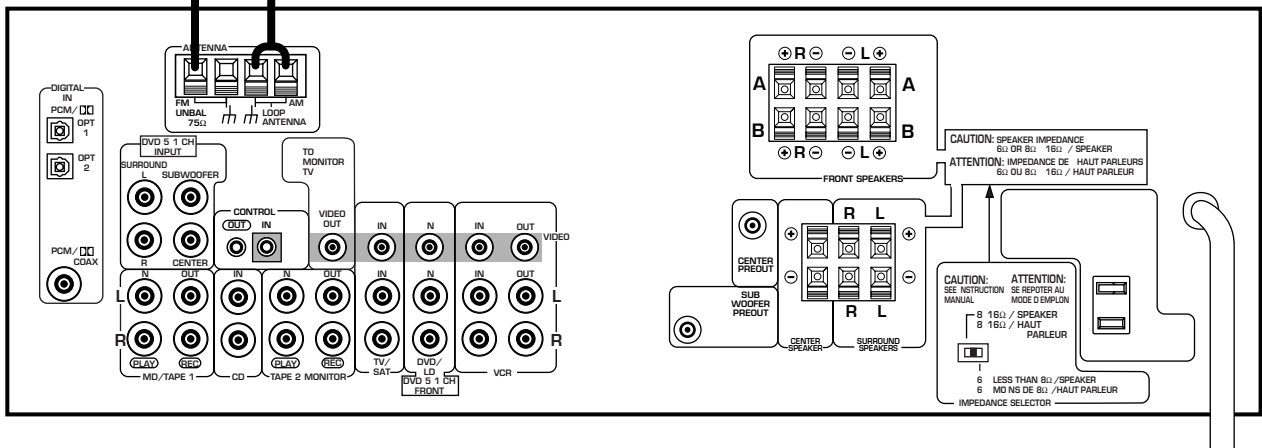

### ■ AM loop antenna

① Assemble the antenna.

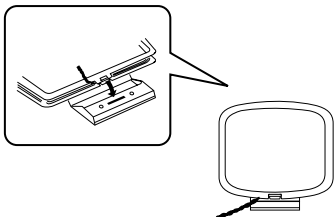

② Twist exposed wire strands together and insert into AM antenna terminals.

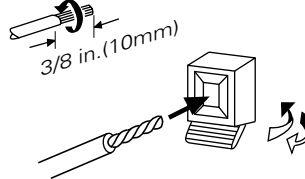

③ Attach to a wall, etc. (if desired) and face toward the direction providing the best reception.

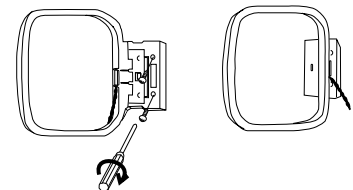

## Using external antennas

### ■ To improve FM reception

Connect an external FM antenna.

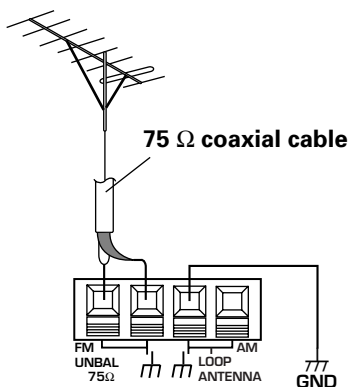

### ■ To improve AM reception

Connect a 15 to 18 feet (5~6 m) length of vinyl-coated wire to the AM antenna terminal in addition to the supplied AM loop antenna. For the best possible reception, suspend horizontally outdoors.

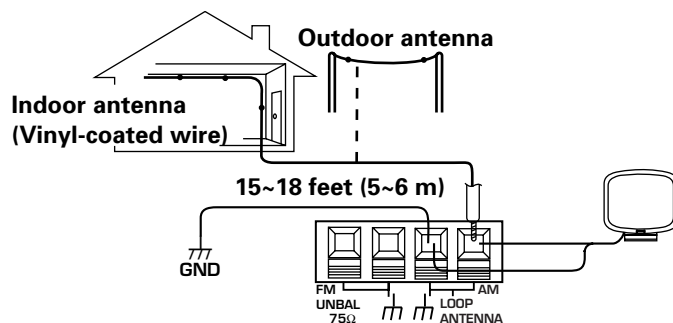



# Audio Components Connections

Be sure to switch power to standby and remove the power cord from the wall outlet when you make or change connections.

Connect your audio components as shown below. Refer to "Digital Connections" on page 11 when making digital connections from your DVD or LD player.

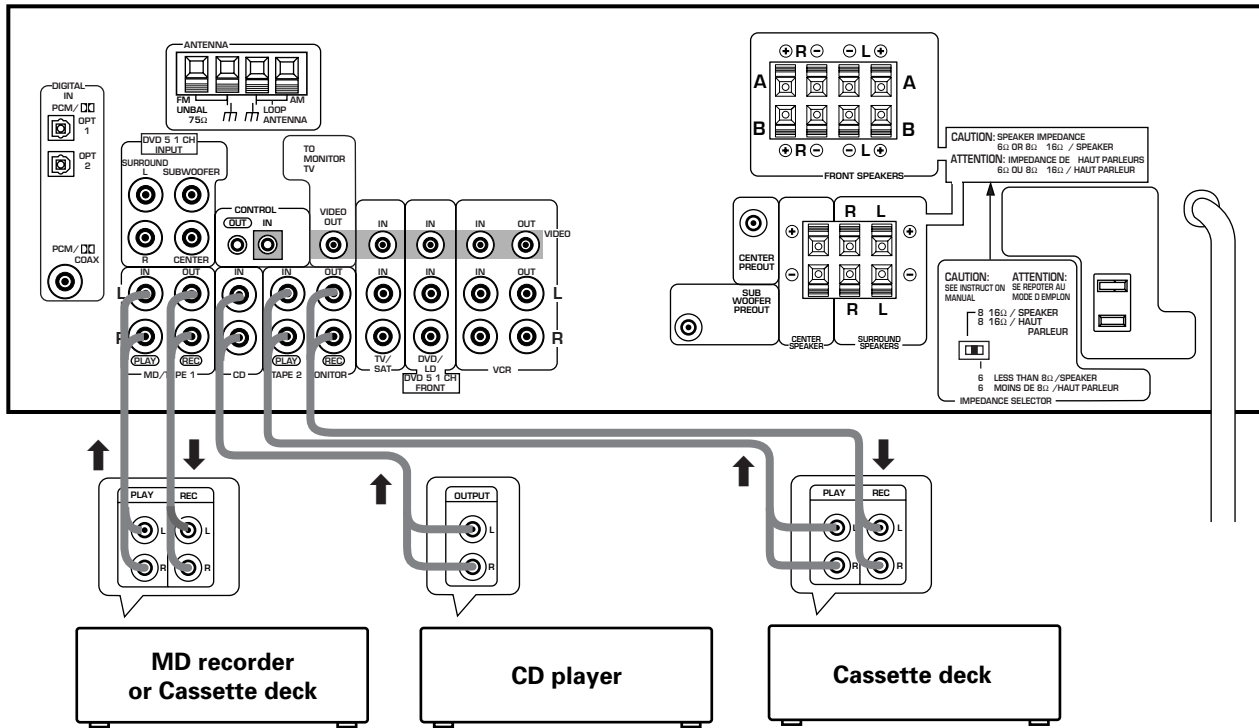

\*The arrows indicate the direction of the audio signal.

## Audio cords

Use audio cords (not supplied) to connect the audio components.

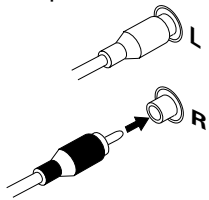

Connect red plugs to R (right) and white plugs to L (left). Be sure to insert completely.

## Cassette deck placement

Depending on where the cassette deck is placed, noise may occur during playback of your cassette deck which is caused by leakage flux from the transformer in the receiver. If you experience noise, move the cassette deck farther away from the receiver.

## Video Components Connections

- Connect your video components as shown below. Also, refer to "Digital Connections" on page 11 when making digital connections from your DVD or LD player.

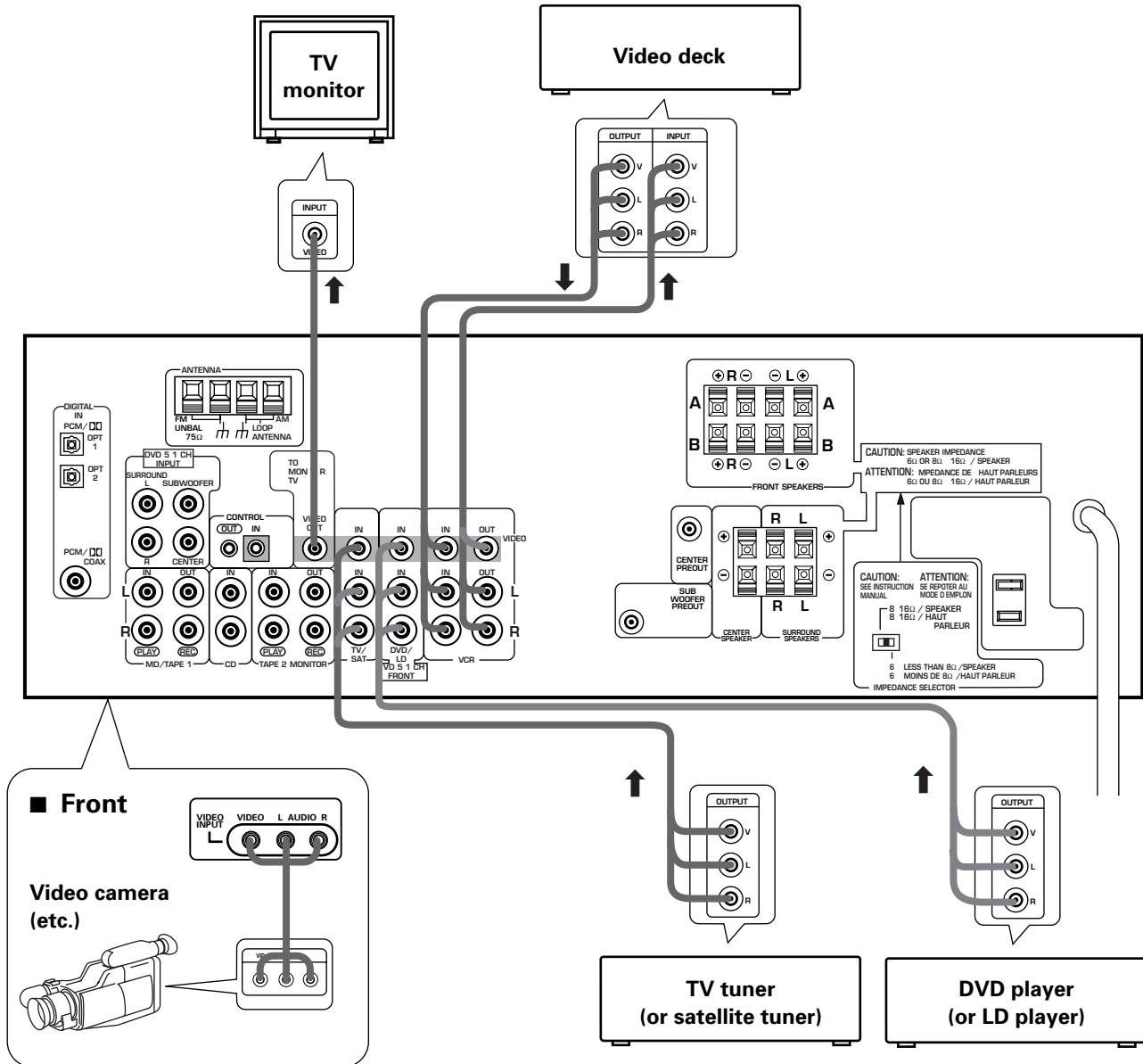

**■ Audio/Video cords**

Use audio/video cords (not supplied) to connect the video components and a video cord to connect the TV or monitor.

Connect red plugs to R (right), white plugs to L (left), and the yellow plugs to VIDEO.

**Be sure to insert completely.**

## Digital Connections

Digital components can be connected as shown below. You can select up to three of the following be assigned to the digital inputs on this unit: DVD/LD, TV/SAT, MD/TAPE1, CD, VCR. To assign the digital inputs, refer to "Setting Up for Surround Sound" on page 15, 19)

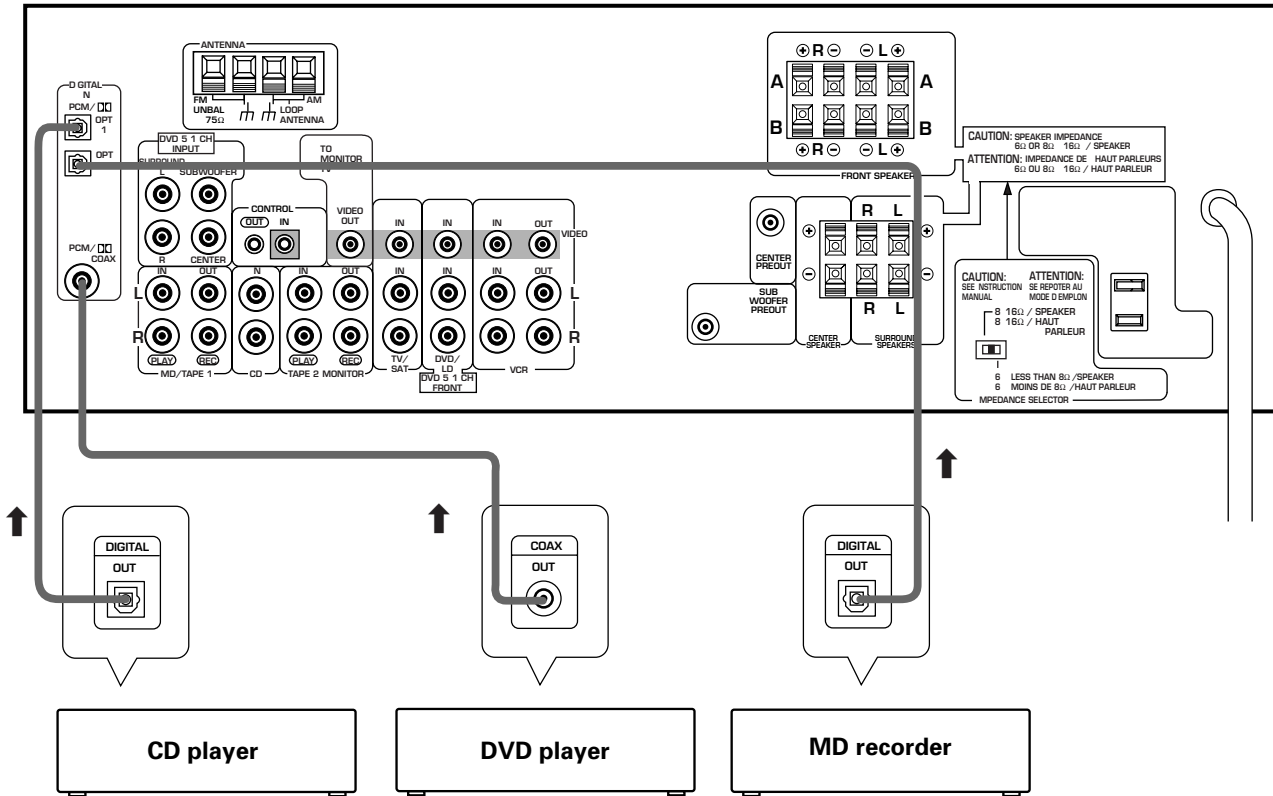

SET UP



### When playing LD recorded in Dolby Digital

When connecting a DVD/LD player or LD player using the AC-3 RF output, a commercially available RF demodulator (RFD-1) is required. The RF demodulator changes the RF signal to a digital signal which is then processed by the receiver through the digital input jacks. For more details, refer to the instruction manual supplied with the RFD-1.

The factory setting for each of the digital inputs is described below.

- COAX : DVD
- OPT 1 : CD
- OPT 2 : MD

### Digital audio cords/Fiber-optic cables

Commercially available digital audio coaxial cord (standard video cords can also be used) or fiber-optic cables (not supplied) are used to connect digital components to this receiver.

When you use optical digital input or output terminals, pull off the caps and insert the plugs. Be sure to insert completely.

#### Digital audio cord (or standard video cord)

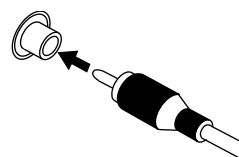

#### Fiber-optic cables

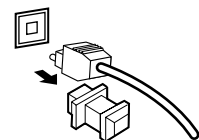

## DVD 5.1 Channel Connection

DVD and LD discs are often compatible with both 2 channel and 5.1 channel audio output formats. Refer to page 30 for more information on how to switch between the two input methods.

Connections can be made from a DVD player, Multi channel decoder equipped with 5.1 analog outputs to the 5.1 analog inputs on this unit.

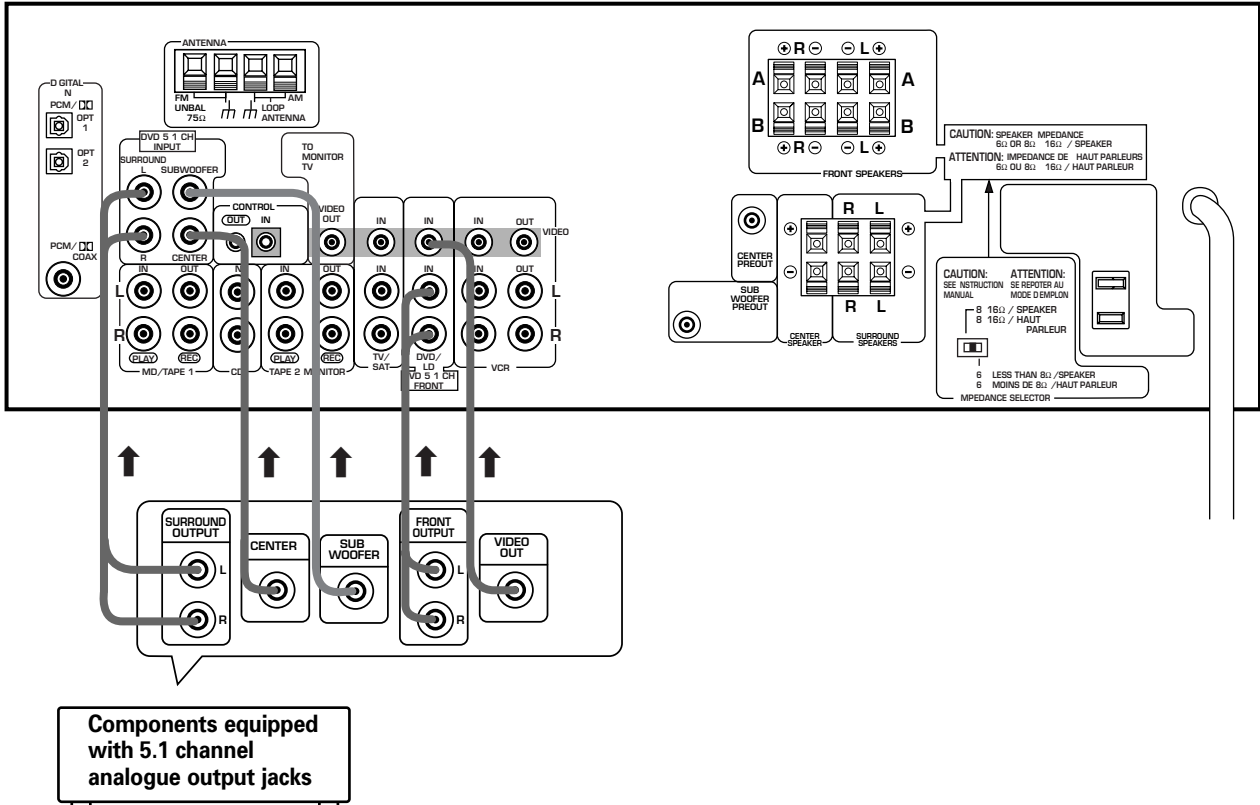

The 5.1 channel input can only be used when DVD/LD is selected.

# Speakers

- Use speakers with a nominal impedance of 6 Ω to 16 Ω.
- The front speaker B terminal is only used in stereo mode (Not available during DVD 5.1 channel, DSP mode, (Dolby Surround mode).
- When you use the speaker on your TV as a center speaker, please connect the CENTER PREOUT jack on this unit to the audio input jack on your TV. In this case, the center speaker shown below is unnecessary. Refer to the instruction manual supplied with the TV or monitor you are connecting to for more information.
- You can set the configuration of your speaker system, whether the sizes of the speakers are large or small, and whether or not you have a sub woofer connected. (Refer to pages 15 to 17)
- No sound is output from the front speakers if both A and B speaker systems are selected, but only one pair of speakers is connected to the FRONT SPEAKERS terminals. To select the speaker system, refer to page 23.

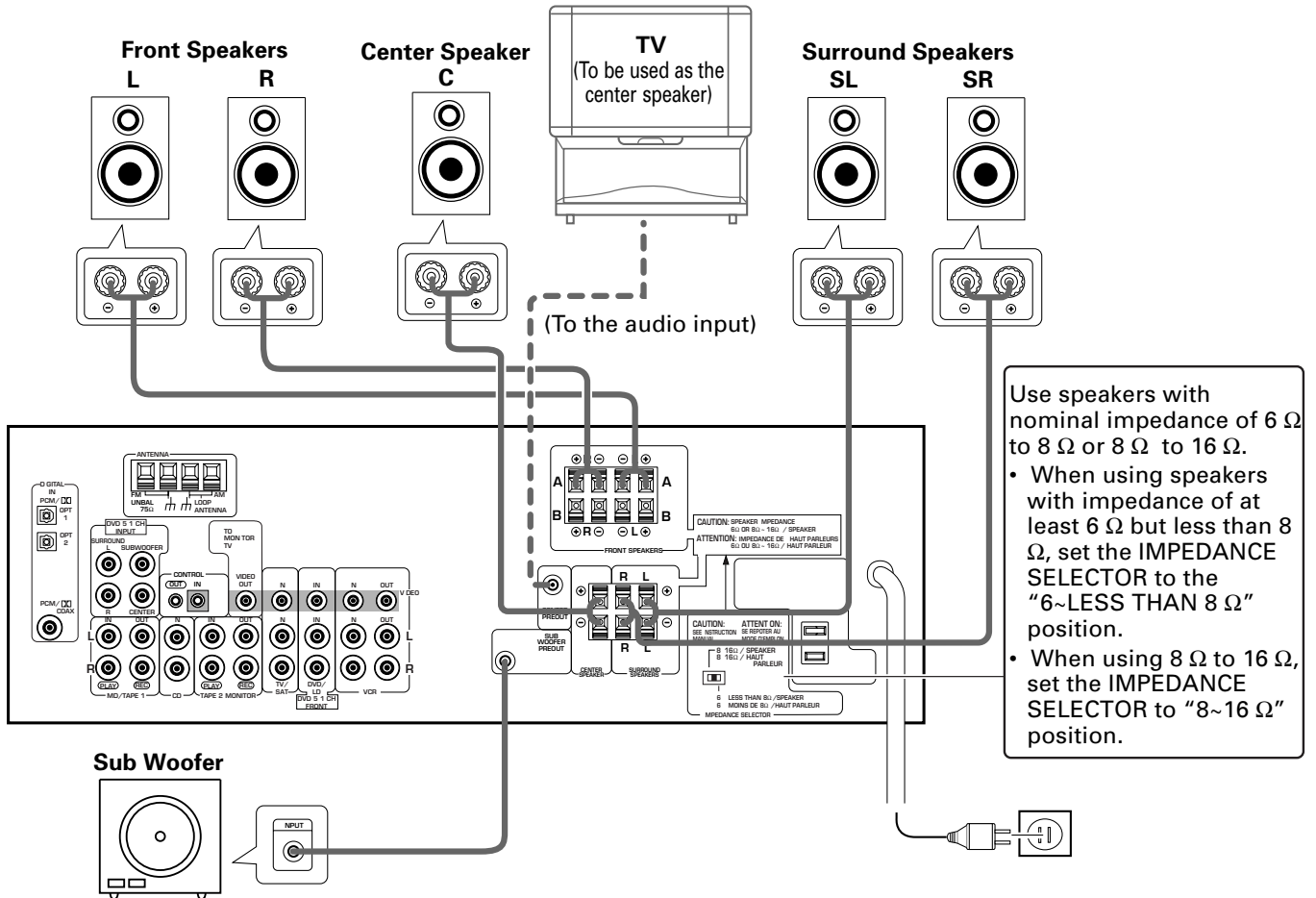

Use speakers with nominal impedance of 6 Ω to 8 Ω or 8 Ω to 16 Ω.

- When using speakers with impedance of at least 6 Ω but less than 8 Ω, set the IMPEDANCE SELECTOR to the "6~LESS THAN 8 Ω" position.
- When using 8 Ω to 16 Ω, set the IMPEDANCE SELECTOR to "8~16 Ω" position.

## Amplified Sub Woofer

Connection methods that differ from the example shown in this manual may be available. For more details, refer to the instruction manual supplied with the sub woofer.

**Be sure to complete all other connections before connecting this unit to the AC power source.**

### ■ Speaker terminals

Twist exposed wire strands together.

Push tab to the open position, and insert the wire. Then, close tab firmly to secure the wire in place.



### Speaker placement

To achieve the best possible surround sound, install your speakers as shown below. Be sure all speakers are installed securely to prevent accidents and improve sound quality.

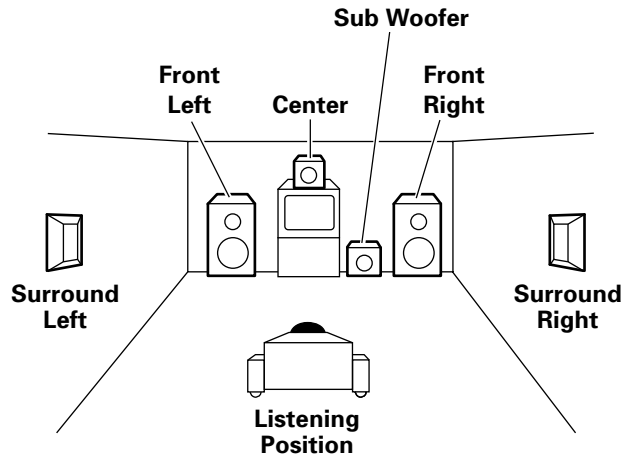

- Install the left and right front speakers at equal distances from the TV.
- When installing speakers near the TV, we recommend using magnetically shielded speakers to prevent possible interference such as distortion in the color of the TV screen. If you do not have magnetically shielded speakers and notice discoloration of the TV screen, place the speakers farther away from the TV.
- Install the center speaker above, below the TV so that the sound of the center channel is localized at the TV screen.

**CAUTION:**

When installing the center speaker on top of the TV, be sure to secure it with tape or some other suitable means.

Otherwise, the speaker may fall from the TV due to external shocks such as earthquakes, and it may lead to endangering those nearby or damaging the speaker.

- If possible, install the surround speakers slightly above ear level.
- It may be difficult to obtain a cohesive surround effect if the surround speakers are installed farther away from the listening position than the front and center speakers.

## Setting Up for Surround Sound

Be sure to switch the power of this unit on (The **STANDBY** indicator goes out) before operating.

To ensure the best possible surround sound, be sure to complete the following set up operations. This is particularly important when using the **Dolby** Surround mode. You only need to make these settings once (unless you change the placement of your current speaker system or add new speakers, etc.). Refer to the following pages for detailed descriptions of the settings available for each mode.

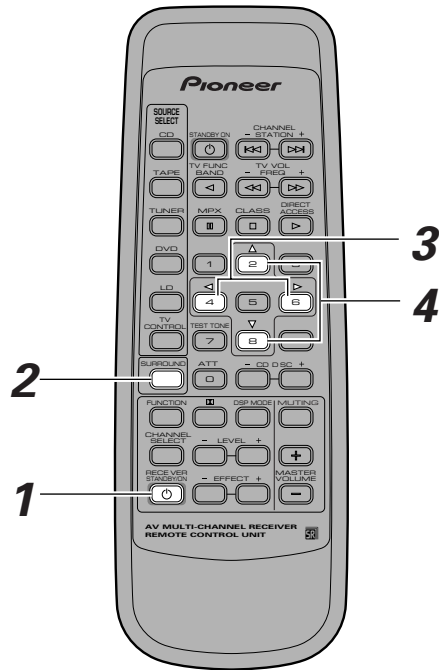

**1 Press RECEIVER  $\odot$  STANDBY/ON to turn the power on.**  
The **STANDBY** indicator goes out.

**2 Press SURROUND.**  
This switches the remote to the surround setup mode.

**3 Press  $\triangleleft$  or  $\triangleright$  to select the mode you desire.**  
For best results, start with "SPEAKER setting mode" and make your initial adjustments in the order described below.

The current settings are displayed automatically.

**SPEAKER (Front, Center, Surround) setting mode (page 16)**

Use to specify the type of speakers you have connected.

**SUB WOOFER ON/OFF setting mode (page 17)**

Use to specify the sub woofer as on or off.

**Crossover frequency setting mode (page 17)**

Use to determine which frequencies will be sent to the sub woofer or "Large" speakers.

**LFE attenuator setting mode (page 17)**

Use to specify the peak level for the LFE channel and the crossover network for rerouted bass frequencies.

**Low cut filter ON/OFF setting mode (page 18)**

Use to cut the distorted sound from the sub woofer.

**FRONT speaker distance setting mode (page 18)**

Use to specify the distance from your listening position to your front speaker.

**CENTER speaker distance setting mode (page 18)**

Use to specify the distance from your listening position to your center speaker.

**SURROUND speaker distance time setting mode (page 18)**

Use to specify the distance from your listening position to your surround speakers.

**Dynamic range control setting mode (page 19)**

Use to compress the dynamic range of the sound track.

**Coaxial digital input setting (page 19)**

Use to specify the input to be assigned to the coaxial digital input.

**Optical digital input 1 setting (page 19)**

Use to specify the input to be assigned to the optical digital input 1.

**Optical digital input 2 setting (page 19)**

Use to specify the input to be assigned to the optical digital input 2.

**4 Press  $\triangle$  or  $\nabla$  to select the setting you desire.**  
The setting is entered automatically.

**5 Repeat steps 3 and 4 to set other surround modes.**



- The setting mode is automatically exited if no operation is performed for 20 seconds.

## SPEAKER setting mode

Establishes the size and configuration of the speaker system you have connected.

In the display, "F", "C", and "S" refer to front, center, and surround speakers respectively. Speaker size is denoted as "L" for large speakers, "S" for small speakers, and "\*" (asterisk) if no speaker is connected.



If the cone size of your speaker is larger than 5 inches (12 cm), please set to Large.

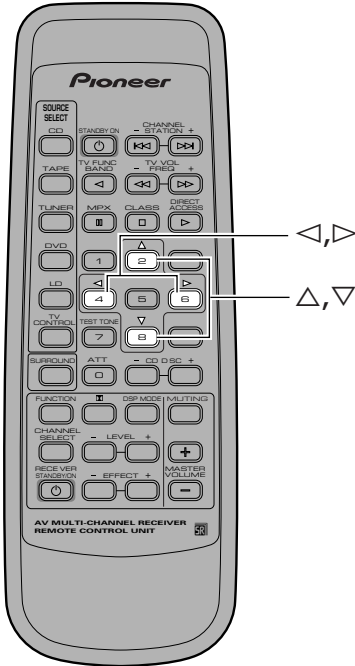

### 1 Press $\Delta$ or $\nabla$ to set the front speaker.

#### Front speaker (initial setting is "L (Large)")

- Select "FL" if your speakers will reproduce bass frequencies effectively or if you did not connect a sub woofer.
- Select "FS" to send bass frequencies to the sub woofer. (The center and surround speakers cannot be set to Large if the front speakers are set to Small. In this case, all bass frequencies are sent to the sub woofer.)

### 2 Press $\Delta$ or $\nabla$ to set the center speaker.

#### Center speaker (initial setting is "L (Large)")

- Select "CL" if your speaker will reproduce bass frequencies effectively.
- Select "CS" to send bass frequencies to the other speakers or sub woofer.
- Select "C\*" if you did not connect a center speaker. In this case, the center channel is output from the front speakers.

### 3 Press $\Delta$ or $\nabla$ to set the surround speaker.

#### Surround speaker (initial setting is "L (Large)")

- Select "SL" if your speakers will reproduce bass frequencies effectively.
- Select "SS" to send bass frequencies to the other speakers or sub woofer.
- Select "S\*" if you did not connect surround speakers. In this case, the sound of the surround channels is output from the front and center speakers.

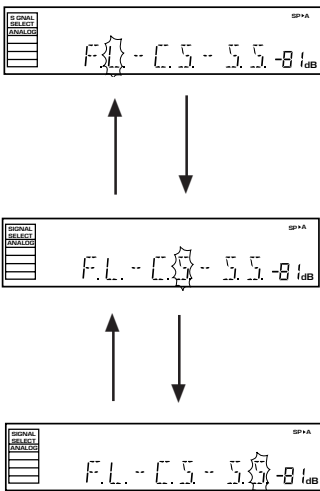

\* Press  $\triangleright$  to advance to the next setting, and press  $\triangleleft$  to return to previous setting.



## SUB WOOFER ON/OFF setting mode

Sets whether the SUB WOOFER is used or not.



- Initial setting is "ON".
- Setting the front speaker size to "Small" in the SPEAKER setting mode automatically locks the sub woofer in the "ON" position.

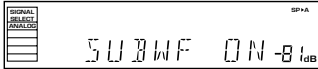

Press  $\Delta$  or  $\nabla$  to select sub woofer ON or OFF.

## Crossover frequency setting mode

Setting speakers to "Small" in "SPEAKER setting mode" sends the respective channels' bass frequencies to the sub woofer (or "Large" speakers). This function lets you determine which frequencies will be sent to the sub woofer or "Large" speakers.



- Initial setting is "100 Hz".
- If all speakers (front, center, and surround) are set to "Large" in SPEAKER setting mode, crossover frequency cannot be set. (\*\*\*) appears in the display.)



Press  $\Delta$  or  $\nabla$  to specify the crossover frequency for your small speakers (100 Hz, 150 Hz or 200 Hz).

### 100 Hz

Sends bass frequencies below 100 Hz to the sub woofer (or Large speakers).

### 150 Hz

Sends bass frequencies below 150 Hz to the sub woofer (or Large speakers).

### 200 Hz

Sends bass frequencies below 200 Hz to the sub woofer (or Large speakers). We recommend setting 200 Hz when only small speakers are used.

## LFE attenuator setting mode

Dolby Digital audio sources include ultra-low bass tones. Set the LFE attenuator as needed to prevent the ultra-low bass tones from distorting the sound from the speakers.



- Initial setting is "0 dB".
- When  $\infty$  is selected (\*\* appears in the display), LFE is not available.



Press  $\Delta$  or  $\nabla$  to set the attenuation level (0 dB, 10 dB or \*\* dB ( $\infty$ )).

### Low cut filter ON/OFF setting mode

Turn the low cut filter ON when distorted sound is output through the sub woofer.



- Initial setting is "OFF".
- If the SUB WOOFER is set to "OFF" in the SUB WOOFER ON/OFF setting mode, the low cut filter cannot be set.



Press  $\Delta$  or  $\nabla$  to select low cut filter ON or OFF.

### FRONT speaker distance setting mode

Sets the distance from the FRONT speaker to the listening position.



- Initial setting is 10 feet.
- One step equals about 1 foot (30 cm).

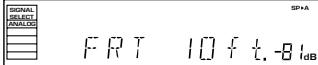

Press  $\Delta$  or  $\nabla$  to set the distance of the FRONT speaker from the main listening position (up to 30 steps).

### CENTER speaker distance setting mode

Normally as the Center speaker is placed directly in front in the listening room, it is closer to the listening position than the Front speakers. This means that the sound from the Center speaker will be heard before the Front speakers. To prevent this, set the Center speaker distance setting to delay the sound from the Center speaker so that the sound from the Front and Center speakers will be heard at the same time.



- Initial setting is 10 feet.
- When "C\*" is selected in SPEAKER setting mode, the Center distance cannot be set.
- One step equals about 1 foot (30 cm).

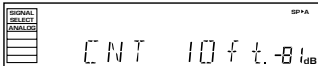

Press  $\Delta$  or  $\nabla$  to set the distance of the CENTER speaker from the main listening position (up to 30 steps).

### SURROUND speaker distance setting mode

Use to set the SURROUND speaker distance. Like the CENTER speaker position, the SURROUND speakers may be set in a location closer or farther than the FRONT speakers. Set the distance of the SURROUND speakers accurately to hear sounds coming from both FRONT and SURROUND speakers at the same time.



- Initial setting is 10 feet.
- When "S\*" is selected in SPEAKER setting mode, the SURROUND distance cannot be set.
- One step equals about 1 foot (30 cm).

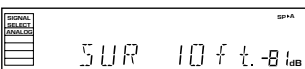

Press  $\Delta$  or  $\nabla$  to set the distance of the SURROUND speaker from the main listening position (up to 30 steps).

## Dynamic range control setting mode

Dynamic range indicates in decibels how loud and soft sounds can be played back properly (so that soft sounds are not covered by noise and loud sounds are not distorted). Dynamic range control is a function which compresses this dynamic range. Even when watching a movie at low volume, setting this function enables low level sounds to be heard more easily.



- Initial setting is "OFF".
- When the volume level is increased, set to OFF.
- For listening enjoyment at low volumes, set to "MAX" for maximum dynamic range compression.
- Dynamic range control is effective only when a Dolby Digital signal is being played back.

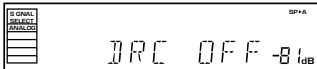

Press  $\Delta$  or  $\nabla$  to set the dynamic range control (OFF, MAX or MID).

## Coaxial digital input setting

Sets the input component to be assigned to the coaxial digital input jack.



- Initial setting is "DVD".

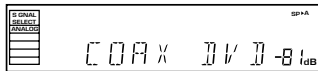

Press  $\Delta$  or  $\nabla$  to select the coaxial digital input (DVD, TV, CD, MD, VCR or OFF).

## Optical digital input 1 setting

Sets the input component to be assigned to the optical input 1 jack.



- Initial setting is "CD".

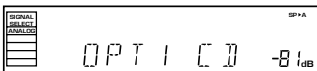

Press  $\Delta$  or  $\nabla$  to select the optical digital input 1 (DVD, TV, CD, MD, VCR or OFF).

## Optical digital input 2 setting

Sets the input to be assigned to the optical input 2 terminal.



- Initial setting is "MD".

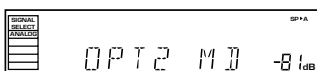

Press  $\Delta$  or  $\nabla$  to select the optical digital input 2 (DVD, TV, CD, MD, VCR or OFF).

## Setting the volume level of each channel (Adjusting the speaker volume balance)



- Sound from the SUB WOOFER seems quite.
- The speaker volume can be adjusted without outputting the test tone by pressing CHANNEL LEVEL or CHANNEL SELECT.
- Initial setting is 0 dB.

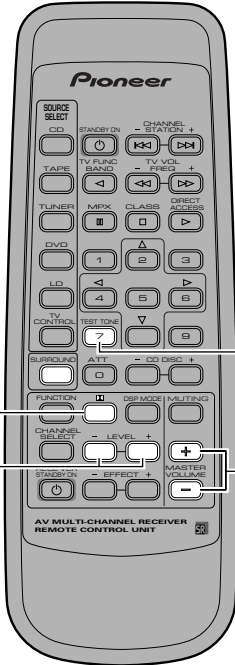

**1** Press **TEST TONE** button.

**2** Press **VOL +** or **-** to adjust the volume to an appropriate level.

**3** Press **TEST TONE** to output the test tone.

The test tone is output in the following order.

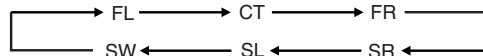

- Depending on the "SPEAKER setting mode" chosen, some channels may not output test tone (refer to page 16).
- Test tone is only output in Dolby mode.

**4** Adjust speaker levels so that you hear the test tone at the same volume from each speaker when seated in the main listening position.

The channel level ranges  $\pm 10$  dB.



- Levels can be set for each surround mode.
- When both the DSP mode and Dolby Surround mode are turned on, priority is given to the Dolby Surround mode.

**5** Press **TEST TONE** to turn off the test tone.

## Display

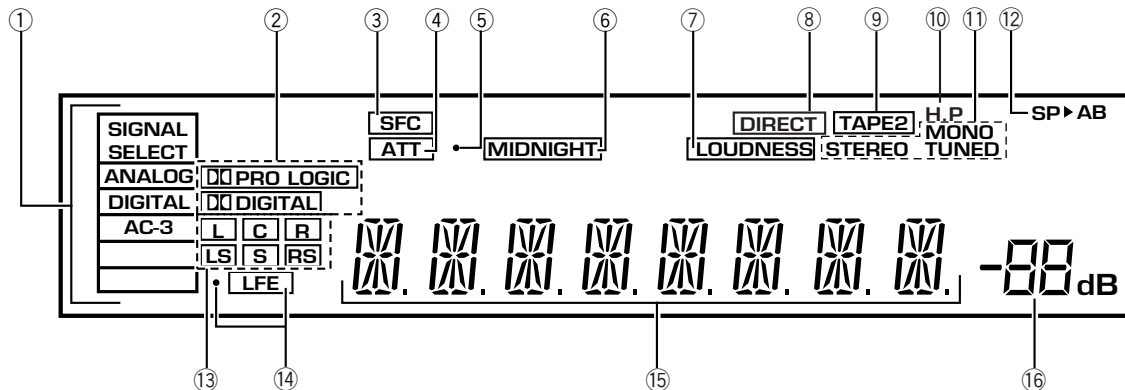

### ① SIGNAL SELECT indicators

Light to indicate the type of input signal selected for the current component (refer to "Front Panel", ⑭, SIGNAL SELECT on pages 23, 24).

**ANALOG** : Lights when the analog audio signals are selected.

**DIGITAL** : Lights when the digital audio signals are selected.

**AC-3** : Lights when a source with Dolby Digital signals is played.

### ② Digital indicators

**PRO LOGIC** : When the Dolby mode on the receiver is on, this indicator lights during 2 channel playback of Dolby Digital sources.

**DIGITAL** : When the Dolby mode on the receiver is on, this indicator lights to indicate playback of a Dolby Digital signal. However, **PRO LOGIC** lights during 2 channel playback of Dolby Digital.

### ③ SFC (DSP) mode indicator

Lights when the DSP mode is selected.  
(Refer to "Surround modes" on page 25)

### ④ ATT indicator

Lights when ATT (refer to "Remote Control", ⑨, Number buttons page 22) is used to reduce the level of the input signal. (available in ANALOG mode only)

### ⑤ Overload indicator

When "ANALOG" is selected in SIGNAL SELECT, this indicator lights when an excessively strong signal is being processed. When this indicator lights, press ATT on the remote control to attenuate (lower) the signal and prevent distortion.

### ⑥ MIDNIGHT indicator

Lights when the MIDNIGHT mode is on.

### ⑦ LOUDNESS indicator

Lights when loudness is on (refer to "Front Panel", ⑪, LOUDNESS on pages 23, 24).

### ⑧ DIRECT indicator

Lights when direct playback is on (refer to "Front Panel", ⑫, DIRECT on pages 23, 24).

### ⑨ TAPE2 indicators

Lights when TAPE 2 MONITOR is on.

### ⑩ H.P indicator

Lights when headphones are plugged in.

### ⑪ Tuner indicators

**STEREO** : Lights when an FM stereo broadcast is received in the auto stereo mode.

**TUNED** : Lights when a broadcast is received.

**MONO** : Lights when the tuner is set to receive FM broadcasts in monaural.

### ⑫ Speaker indicators

Light to indicate the current speaker system (refer to "Front Panel", ⑦, SPEAKERS (A/B) on pages 23, 24).

**SP A** : Lights when speaker system A is selected.

**SP B** : Lights when speaker system B is selected.

### ⑬ Program format indicators

The following indicators light to show the channels being played back.

**L** : Left front<sup>\*1\*2</sup>, **C** : Center<sup>\*1</sup>, **R** : Right front<sup>\*1\*2</sup>,  
**LS** : Left surround<sup>\*1</sup>, **S** : Surround (mono)<sup>\*2</sup>,  
**RS** : Right surround<sup>\*1</sup>

\*1: Indicates 5.1ch Dolby Digital playback.

\*2: Indicates Dolby Pro Logic playback.

### ⑭ LFE indicator

LFE (Low Frequency Effects) indicator lights to indicate that the program source contains an LFE channel. The indicator to the left of LFE lights during actual playback of the LFE signals (LFE signals are not present in all parts of the sound track).

### ⑮ Character display

### ⑯ Volume level display

Displays the volume level. Volume level is maintained even when the power is off. ---dB indicates the minimum level, and 0dB indicates the maximum level.

- Depending on the level settings for individual channels, the MAX level can range between -10dB and 0dB.

## Remote Control

These pages describe the buttons on the remote control used to operate the receiver.

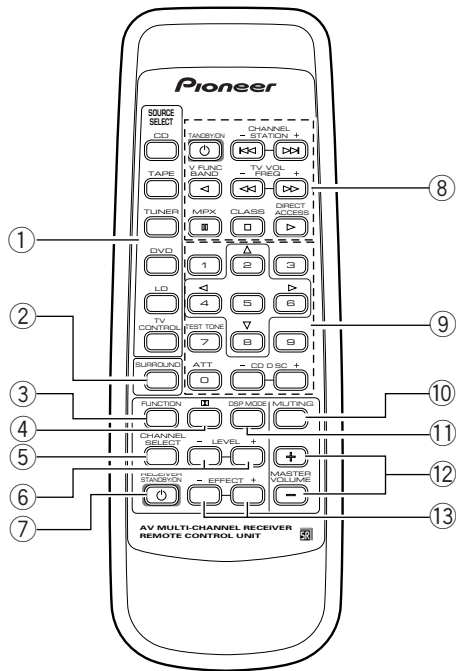

**① SOURCE SELECT buttons**

Use these buttons to select the remote operation mode.  
For example, pressing TUNER sets the remote to operate the tuner functions.

**② SURROUND button**

Press to select the receiver for remote control operation.

**③ FUNCTION button**

Press repeatedly to select a source.

**④ **

Press repeatedly to select the  (Dolby) Surround mode.  
(refer to page 28)

**⑤ CHANNEL SELECT**

Use to select a speaker when adjusting speaker levels.

**⑥ LEVEL (-/+)**

Use to adjust individual speaker levels.

**⑦ RECEIVER  STANDBY/ON button**

Press to switch the receiver on or to put in standby.

**⑧ TUNER operations**(press TUNER first)(refer to page 32-35)

**CHANNEL STATION(+/-)** : Selects next /Previous preset station.

**TV FUNC.BAND** : Switches between AM and FM bands.

**TV VOL.FREQ.** :Changes the tuner frequency.

**MPX** : switches between stereo and mono.

**CLASS** :changes preset bank(class)

**DIRECT ACCESS** : allows direct keying in of

frequency.

**⑨ Number buttons/Surround setting buttons**

These buttons can perform a variety of different functions depending on the remote operation mode.

**• [RECEIVER operations (press SURROUND first)]**

**△/▽/◀/▶ buttons** : Specific use of these buttons is described in conjunction with the operations they are used in.

**TEST TONE** : Press to switch the test tone on or off when listening to a surround mode (refer to page 20).

**ATT** : Press to attenuate (lower) the level of the input signals and prevent distortion (refer to "Display", ⑤, Overload indicator on page 21).

**• [TUNER operations (press TUNER first)]**

**Number buttons (0~9)** : During preset tuning, use to input the number of the preset station. Use to input the station frequency during direct tuning.

**⑩ MUTING button**

Press to mute the volume. "MUTING" appears in the display. Press again to cancel.

**⑪ DSP MODE**

Press repeatedly to select a DSP sound mode (refer to page 29).

**⑫ MASTER VOLUME(+/-) buttons**

Press to adjust the volume. When VOL (+/-) buttons are pressed while muting, muting is canceled.

**⑬ EFFECT (+/-)**

Use to adjust the DSP mode effect level.

## Front Panel

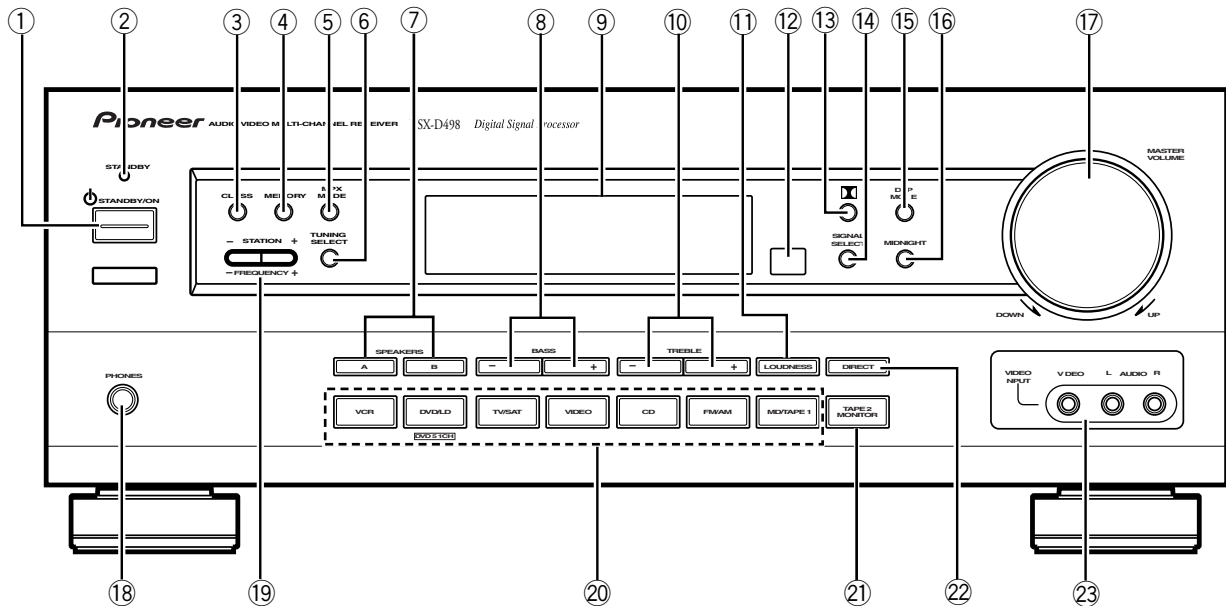

- ① **STANDBY/ON button**  
Press to switch the receiver on or put in standby.
- ② **STANDBY indicator**  
Lights when the receiver is in standby mode. (Please note that this receiver consumes a small amount of power (2.5 W) during the standby mode.)
- ③ **CLASS button**  
Press repeatedly to switch the preset station classes. (Refer to "Memorizing Frequency Tuned Stations" on page 34 and "Recalling the Memorizing Stations" on page 35)
- ④ **MEMORY button**  
Press to memorize a preset station. (Refer to "Memorizing Frequency Tuned Stations" on page 34)
- ⑤ **MPX MODE button**  
Press to switch between auto stereo and monaural ("MONO") reception of FM broadcasts. When the broadcast signal is weak, selecting "MONO" will improve the sound quality.
- ⑥ **TUNING SELECT button**  
Press to switch between STATION and FREQUENCY.
- ⑦ **SPEAKERS (A/B) buttons**  
Use to switch the corresponding speaker system on or off. To listen to both speaker systems (A and B), press the buttons so that both A and B appear in the display (refer to "Display", ⑨, Speaker indicators on page 21). Only A speakers are available when using surround sound modes.
- ⑧ **BASS (+/-) button**  
Press to adjust low frequencies in the range of  $\pm 6$ .
- ⑨ **Display (Refer to page 21)**
- ⑩ **TREBLE (+/-) button**  
Used to adjust high frequencies in the range of  $\pm 6$ .
- ⑪ **LOUDNESS button**  
Switches the loudness on or off. Use to raise the level of the bass and treble frequencies so they can be more easily heard when listening at low volumes.
- ⑫ **Remote sensor**  
Point the remote control toward the remote sensor to operate the receiver.
- ⑬ **Surround button**  
Press to select the  (Dolby) Surround mode. This mode automatically switches between Dolby Digital and Dolby Pro Logic decoding according to the input signal. (Refer to page 28 for more information about Dolby Digital.)

### ⑭ **SIGNAL SELECT button**

Use to select input signals for the digital components. First press DVD/LD, TV/SAT, MD/TAPE 1, CD or VCR (⑳ Function buttons) to select the component, then press SIGNAL SELECT repeatedly to select one of the following:

**ANALOG** : Selects the analog (R and L) audio signals.

**DIGITAL** : Selects the digital audio signals. This receiver automatically detects and displays the format of the signal being input. AC-3 lights when Dolby Digital signals are input. (Dolby Digital decoding is switched automatically.)

- SIGNAL SELECT is fixed in the "ANALOG" position for components not assigned to one of the three digital input jacks.
- Because the audio from a karaoke microphone and LD recorded with analog audio only is not output from the digital output, set SIGNAL SELECT to "ANALOG".
- This receiver can only play back Dolby Digital, PCM (32kHz, 44kHz, and 48kHz), digital signal formats. With digital signal formats other than these, set SIGNAL SELECT to "ANALOG".

### ⑮ **DSP MODE button**

Press repeatedly to select a DSP sound mode (HALL 1, HALL 2, JAZZ, DANCE, THEATER 1, or THEATER 2). Use these modes to produce surround sound from standard (two channel) stereo sources.

### ⑯ **MIDNIGHT button**

Press to hear effective surround sound at low volume levels. The effect is automatically adjusted according to the volume level.

### ⑰ **MASTER VOLUME**

After turning on the desired component, rotate to adjust the volume.

### ⑱ **PHONES jack**

Connect headphones for private listening (the speakers turn off automatically).

### ⑲ **STATION/FREQUENCY (+/-) button**

**STATION**: Press to select the preset channel.

**FREQUENCY**: Press to select the frequency.

### ⑳ **Function buttons**

Selects the function. Each press switches the DVD/LD input between DVD/LD and DVD 5.1 channel.

### ㉑ **TAPE 2 MONITOR button**

Switches the TAPE 2 monitor on or off (refer to page 36).

### ㉒ **DIRECT button**

Switches direct playback on or off. Use to bypass the receiver's tone control circuitry or level control for higher fidelity to the program source. When DIRECT is ON, Dolby, DSP, LOUDNESS and MIDNIGHT mode are automatically turned OFF.

### ㉓ **VIDEO INPUT jacks**

Connect a video camera, video game system, etc. to the VIDEO INPUT jacks (refer to page 10).



# Sound Modes

This receiver incorporates two surround modes for enjoyment of a variety of program sources.

## Surround modes

### (Dolby) Surround mode

Use this mode when playing Dolby Digital or Dolby Surround software. Decoding switches automatically according to the input signal, so all you have to do is enjoy!

You can identify Dolby Digital software by the  or  marks. Most Dolby Surround software is marked , but unmarked software may also incorporate Dolby Pro Logic.

For more information about Dolby formats, refer to page 43.

## DSP modes

The DSP (Digital Sound Processing) modes allow you to transform your living room into a variety of different sonic environments when playing standard (two-channel) stereo sources, Dolby Surround sources, and Dolby Digital sources.

### HALL 1

Simulates the acoustic environment of a large concert hall of wooden construction. Complex delay of reflected sounds coupled with reverberation effects create a dynamic and beautiful sound characteristic of an orchestra performing in a concert hall, making it suitable for classical music.

### HALL 2

Simulates the acoustic environment of a large concert hall with stone walls. The rich reverberations and natural fullness of the sound create the auditory impression of being in a concert hall, making it suitable for classical music.

### JAZZ

Simulates the acoustic environment of a jazz club. Less delay on the reflected sounds emphasizes the sensation of hearing a live band.

### DANCE

Simulates the acoustic environment and strong bass sound of a nightclub with a square dance floor. A short delay on the reflected sounds emulates the raw power of the dance music.

### THEATER 1

Adjusts the delay of the reflected sound to simulate the acoustic environment of a medium sized movie theater.

### THEATER 2

Simulates the acoustic environment of a theater while maintaining proper localization of each channel.

## Switching ANALOG/DIGITAL Signal Input

The input of the component set in the digital input setting (refer to page 19) can be switched to an analog or digital input signal by pressing the SIGNAL SELECT button.

### 1 Press SIGNAL SELECT on the front panel to select the input signal corresponding to the source component.

Each press switches between ANALOG and DIGITAL signal selection.

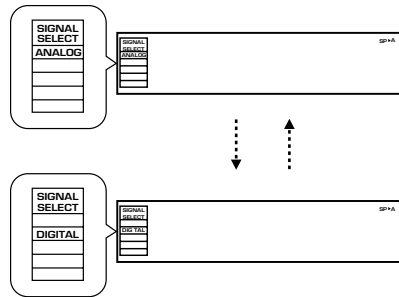

### 2 While SIGNAL SELECT is set to DIGITAL, AC-3 lights when a Dolby Digital signal is input.

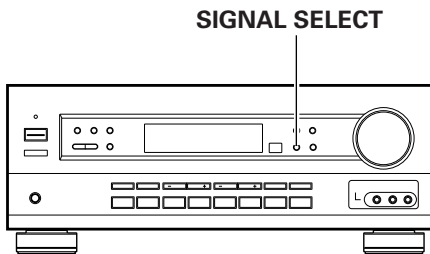
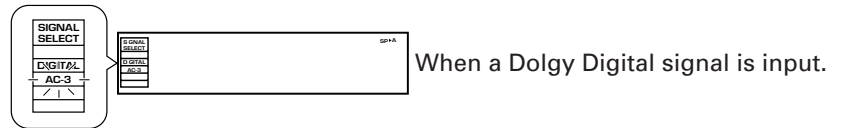

- SIGNAL SELECT is fixed in the "ANALOG" position for components not assigned to one of the three digital input jacks.
- Because the audio from a karaoke microphone and LD recorded with analog audio only is not output from the digital output, set SIGNAL SELECT to "ANALOG".
- This receiver can only play back Dolby Digital, PCM (32kHz, 44kHz, and 48kHz), digital signal formats. With digital signal formats other than these, set SIGNAL SELECT to "ANALOG".

# Playback

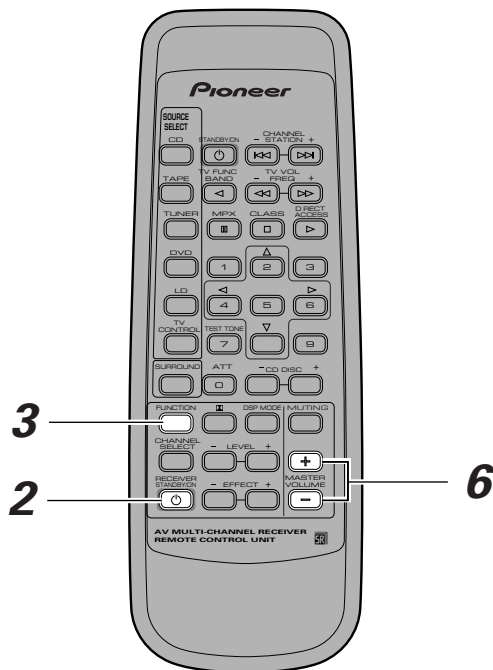

**1** Turn on the power of the playback component.

**2** Press **RECEIVER** **STANDBY/ON** to turn on the receiver.  
Be sure that the standby indicator turns off on the front panel.

**STANDBY indicator**

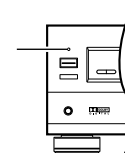

**3** Press **FUNCTION** to select the source you want to playback.

The source you want to playback is displayed in the following order:



**4** Press **SIGNAL SELECT** on the front panel to select the input signal corresponding to the source component.  
(Refer to "Switching ANALOG/DIGITAL signal input" on page 26.)

**5** Start playback of the component you selected in step 1.

**6** Press **VOL (+/-)** to adjust the volume level in the range of --- dB (MIN) to 0 dB (MAX).

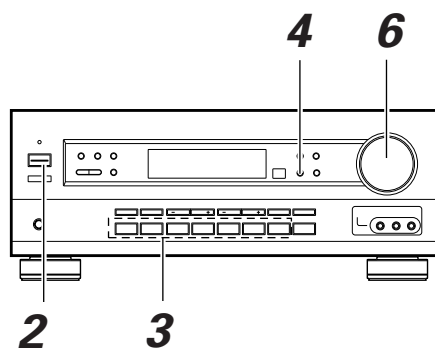

- Depending on the channel level setting, the MAX volume level may differ 0 to -10 dB from the level displayed.

## Playing Sources with Dolby Digital Sound

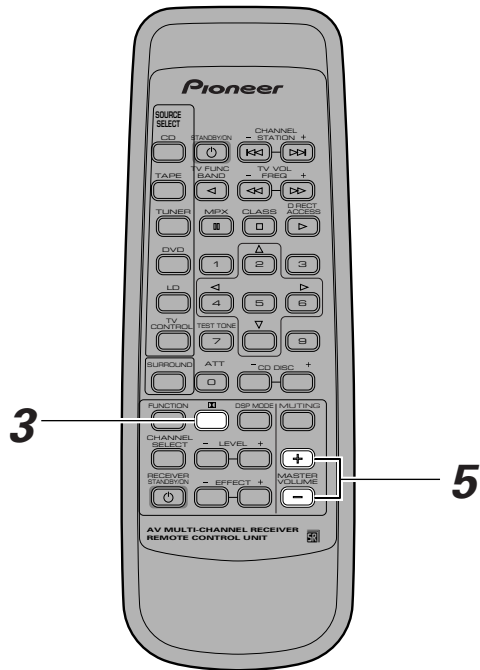

**1** Follow steps 1 to 3 of the playback procedure. (Refer to "Playback" on page 27.)

- ① Turn on the power of the playback component.
- ② Press RECEIVER  $\odot$  STADBY/ON to turn on the receiver.
- ③ Press FUNCTION to select the source component you want to play.

**2** Press **SIGNAL SELECT** on the front panel to select **DIGITAL**.

(Refer to "Switching ANALOG/DIGITAL signal input" on the previous page.)

**3** Press  $\square$  to switch the **Dolby Surround** mode on.

**4** Start playback of the component you selected in step 1.

**5** Press **VOL (+/-)** to adjust the volume level.

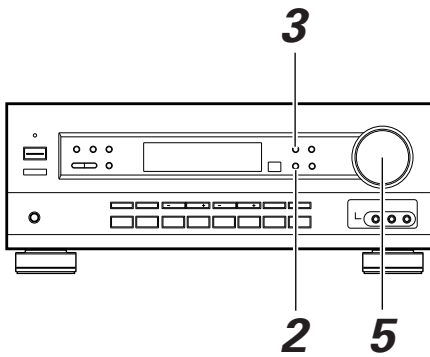

### When playing LD recorded in Dolby Digital

When connecting a DVD/LD player or LD player using the AC-3 RF output, a commercially available RF demodulator (RFD-1) is required. The RF demodulator changes the RF signal to a digital signal which is then processed by the receiver at the digital input jacks. For more details, refer to the instruction manual supplied with the RFD-1.

Refer to pages 43 for explanations Dolby Digital, Dolby Pro Logic.

## Selecting a Sound Mode

To ensure the best possible surround sound, be sure to complete the set up procedures described in "Setting Up for Surround Sound" (starting on page 15) before using the sound modes. This is particularly important when using the **DD** (Dolby) Surround mode. When using the sound modes, SPEAKERS A are used. If SPEAKERS B are selected and a sound mode is turned on, selection automatically switches to SPEAKERS A only.

### Surround operation

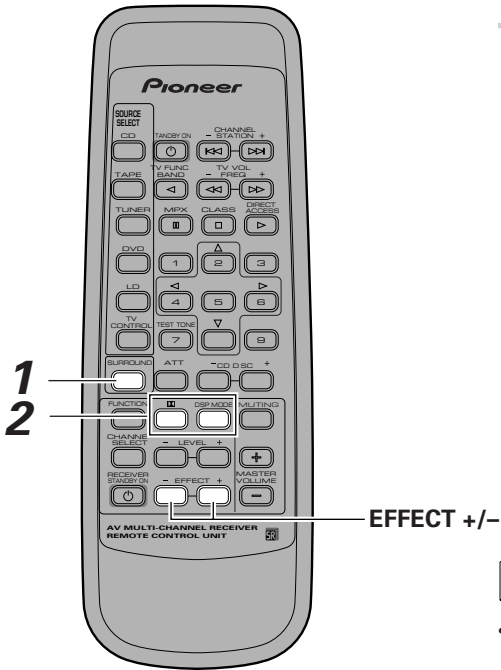

#### Select the sound mode.

- For **DD** (Dolby) → Press **DD**
- For DSP modes → Press DSP MODE repeatedly  
Each press changes the DSP mode as follows:

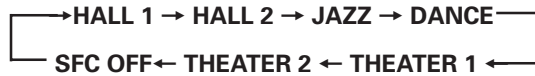

- The amount of effect of each DSP mode can be adjusted in the range of 10 to 90 (the default setting value is 70) by pressing EFFECT +/-.
- Dolby Digital or Dolby Surround sources can be used simultaneously with DSP modes.

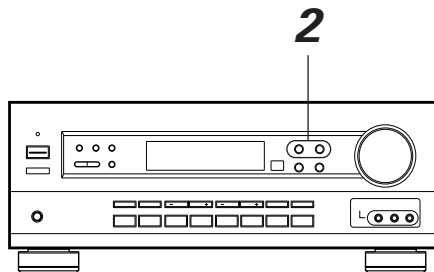

## DVD 5.1ch Input Playback

Connect a component with 5.1 channel output to enjoy the surround sound created by 5.1 channel playback.

Press DVD/LD on the unit.

Each press switches the input: DVD/LD ↔ DVD 5.1ch

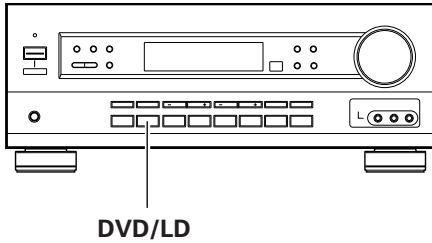

- When DVD 5.1ch input is selected, Dolby Surround mode, DSP mode, SIGNAL SELECT, ATT, DIRECT, TONE, MIDNIGHT mode, and speakers B cannot be operated.
- When DVD 5.1ch input is selected, only the volume level and channel levels can be set.

## Listening in MIDNIGHT Listening Mode

When the volume is low, surround effects tend to become less than satisfactory. Turn the MIDNIGHT listening mode on to enjoy the effects of quality surround sound even at low volumes. This mode allows you to hear effective surround sound of movies at low volume levels.

Press MIDNIGHT.

Each press switches MIDNIGHT listening mode on or off.

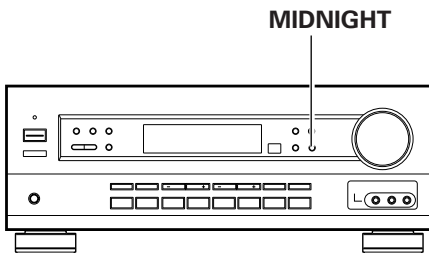

The effect automatically adjusts according to the volume level.

## Adjusting Bass and Treble Frequencies (Tone Control)

Use BASS (+/-) or TREBLE (+/-) to adjust the low and high frequencies.

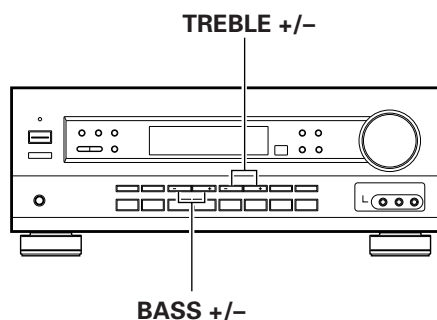

Press BASS (+/-) to adjust the low frequencies.

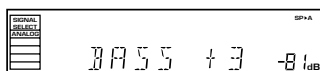

Press TREBLE (+/-) to adjust the high frequencies.

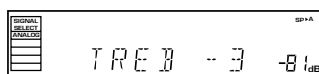

- The tone control can be adjusted in a range of  $\pm 6$ .
- Pressing + and - simultaneously restores the setting to 0.
- In cases described below, the tone control cannot be adjusted.
  - ① Dolby Surround mode is ON.
  - ② DSP mode is ON.
  - ③ DVD 5.1ch input is selected.
  - ④ Dolby Digital signals are being input.

## Automatic and Manual Tuning

The following steps show you how to tune in FM and AM radio broadcasts using the automatic (search) and manual (step) tuning functions. If you already know the exact frequency of the station you want, see "Direct Tuning" on the following page.

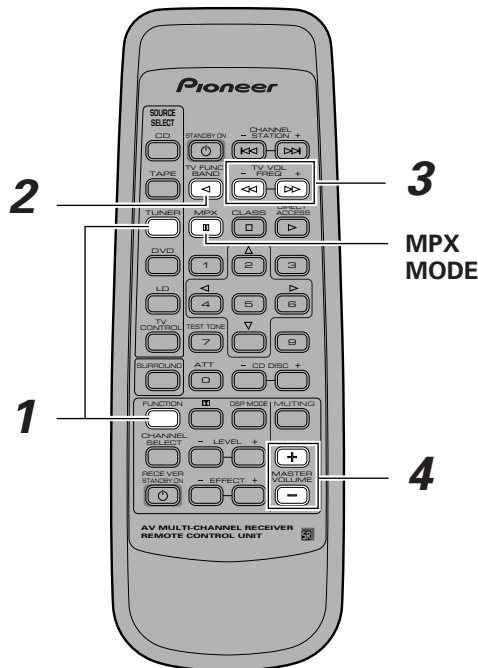

- 1 Press FUNCTION repeatedly on the remote or FM/AM on the front panel to select the tuner. Press TUNER to set the remote to the tuner operation mode.**

The station you were previously tuned to is received automatically.

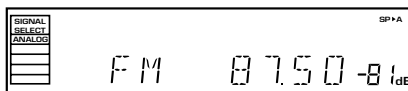

- 2 Press TV FUNC.BAND on the remote or FM/AM on the front panel to select the band (FM or AM).**

Each press switches the band: FM ↔ AM



- 3 Tune in the station.**

### For Automatic Tuning

Press and hold TV VOL.FREQ.(+/-) for about one second, then release.

The tuner starts searching the selected band and stops automatically at the first station it locates. Repeat to locate other stations.

### For Manual Tuning

- To change frequencies one step at a time, press TV VOL.FREQ.(+/-) repeatedly.
- To change frequencies quickly, hold down TV VOL.FREQ.(+/-) and release when you reach the frequency you want.

### When using the front panel

Press FREQUENCY (+/-) until the frequency you want appears in the display.

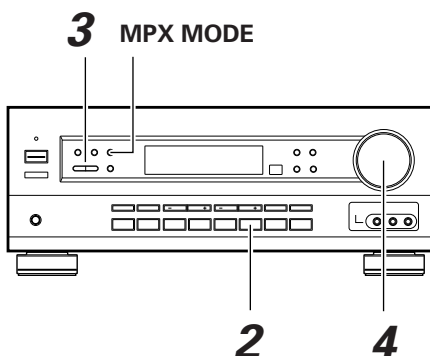

- 4 Adjust the volume.**

## MPX Mode

If the TUNED or STEREO indicators do not light when tuning an FM station, because the station is too far away or the broadcast signal is weak, press MPX MODE on the front panel to switch to monaural (MONO) reception. This should improve reception enough for you to enjoy the broadcast.



## Direct Tuning

The following steps show you how to tune directly to a specific frequency using the remote control.

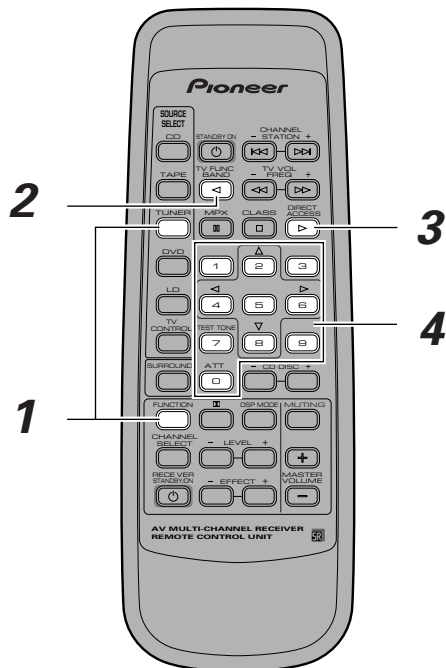

- 1 Press FUNCTION repeatedly on the remote or FM/AM on the front panel to select the tuner. Press TUNER to set the remote to the tuner operation mode.**

The station you were previously tuned to is received automatically.

- 2 Press TV FUNC. BAND to select the band (FM or AM).**  
Each press switches the band: FM ↔ AM

- 3 Press DIRECT ACCESS to activate the direct tuning mode.**  
The cursor blinks in the display on the front panel.

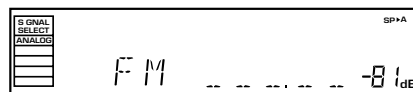

- 4 Use the number buttons to enter the frequency of the station you want.**

**Example:**

To tune station 106.00 (FM), press: ① → ⑥ → ⑦ → ① → ①

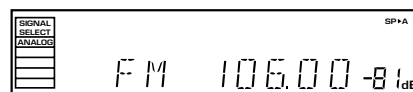

**To cancel before inputting the frequency**

Press DIRECT ACCESS, and enter the frequency again.

## Memorizing Frequently Tuned Stations

The following steps show you how to memorize up to 30 radio stations in 3 classes (each holding 10 channels). When memorizing FM frequencies, the receiver also memorizes the MPX mode (STEREO or MONO).

### Using the front panel

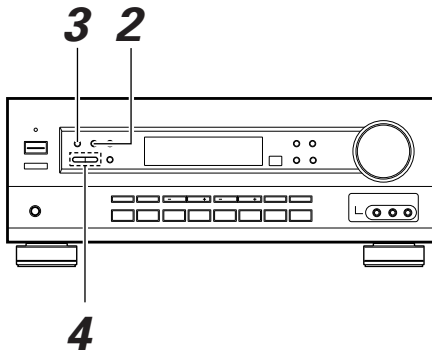

#### 1 Tune to the desired station.

See "Automatic and Manual Tuning" or "Direct Tuning" on pages 32, 33.

#### 2 Press MEMORY to activate the memory function.

"A--" blinks in the display.



#### 3 Press CLASS repeatedly to select a class.

Each press switches the display:

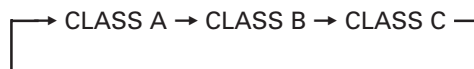

#### 4 Press STATION (+/-) to select a channel (1~10) within the respective class.



The station is memorized automatically after 5 seconds.

**Repeat steps 1 through 4 to memorize up to 30 stations.**

# Recalling the Memorized Stations

## Using the remote control

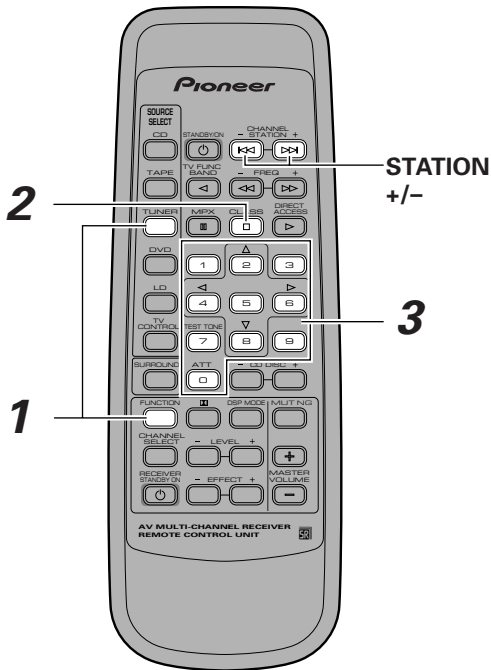

- 1 Press **FUNCTION** repeatedly on the remote or **FM/AM** on the front panel to select the tuner. Press **TUNER** to set the remote to the tuner operation mode.

The station you were previously tuned to is received automatically.

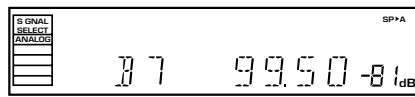

- 2 Press **CLASS** repeatedly to select a class.

Each press switches the display:

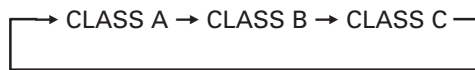

- 3 Use the **number buttons** to select the channel you want.

To select channel 7, press ⑦.

To select channel 10, press ⑩.

**For example** : If 99.50 MHz (FM) was memorized in class B at channel 7.

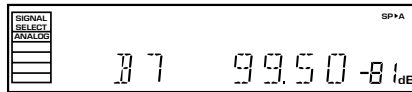

### To skip through each channel in order

Press **STATION +/-** repeatedly.

## Using the front panel

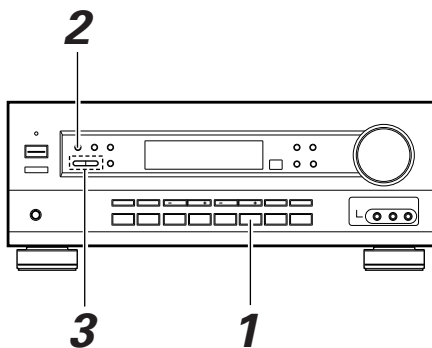

- 1 Press **FM/AM**.
- 2 Press **CLASS** repeatedly to select a class.
- 3 Press **STATION +/-** to select the channel you want.

## Recording from Audio Components

The following operations show you how to record audio to the cassette, DAT, or MD deck connected to the MD/TAPE 1 or TAPE 2 MONITOR jacks.



The receiver's volume, tone (BASS, TREBLE, and LOUDNESS), and surround effects have no effect on the recorded signal.

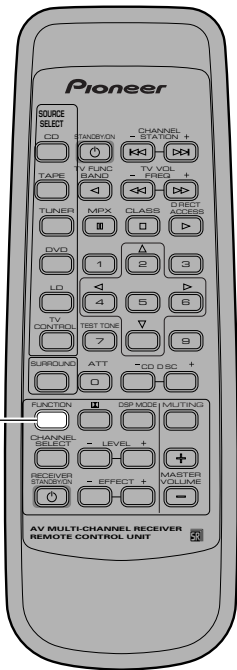

### 1 Select the component you want to record.

Be sure to press SIGNAL SELECT on the front panel to choose "ANALOG". (Refer to "Switching ANALOG/DIGITAL signal input" on page 26.)

### 2 Prepare the program source.

(Tune in the radio station or load the CD, etc.)

### 3 Insert a blank tape into the cassette deck (MD/TAPE 1 or TAPE 2 MONITOR) and adjust the recording level (if necessary).

### 4 Start recording on the cassette deck, then start playback from the source component.

## Record monitor (TAPE 2 MONITOR)

If you connect a cassette deck (etc.) with a record monitor function to the TAPE 2 MONITOR jacks, you can listen to the sound of the recording as it is being recorded.

**Press TAPE 2 MONITOR to switch between the sound of the recording (TAPE 2 indicator on) and the sound of the source component (TAPE 2 indicator off).**



- This receiver outputs the input signal directly to the recording device. As there is no conversion of the audio signal, recordings cannot be made from analog to digital, and similarly from digital to analog.
- The MD/TAPE 1 function is not able to record the TAPE 2 MONITOR.

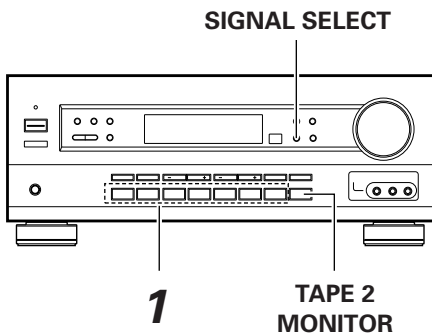

## Recording from Video Components

The following operations show you how to record audio and video to the video tape recorder connected to the VCR jacks.



The receiver's volume, tone (BASS, TREBLE, and LOUDNESS), and surround effects have no effect on the recorded signal.

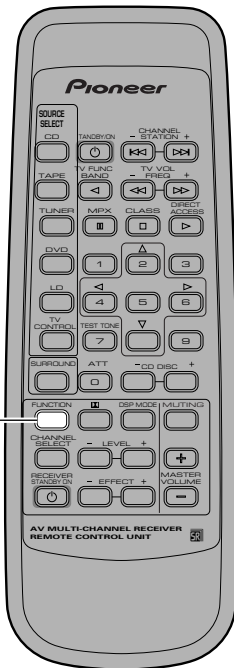

### 1 Select the component you want to record.

Be sure to press SIGNAL SELECT on the front panel to choose "ANALOG". (Refer to "Switching ANALOG/DIGITAL signal input" on page 26.)

### 2 Prepare the program source.

(Load the DVD or LD, etc.)

### 3 Insert a blank tape into the video tape recorder VCR.

### 4 Start recording on the video tape recorder, then start playback from the source component.



- Recording cannot be made from analog to digital, and similarly from digital to analog.
- When recording a DVD, the recorded image may flicker or be difficult to view because of the copy protection signal programmed on the DVD.

SIGNAL SELECT

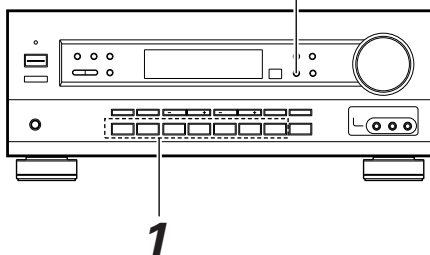

## Remote Controlling Other PIONEER Components

### DVD player operations



Before to performing these operations, press the DVD (SOURCE SELECT) button to switch the remote to the DVD operation mode.

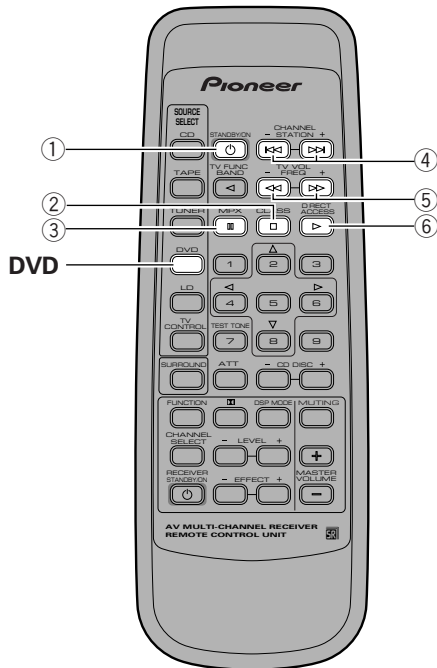

- ① Press to switch the DVD player on or off.
- ② Press to stop playback. (With certain models, pressing this button when the unit is stopped may open the disc tray.)
- ③ Press to pause playback. (With certain models, this button may freeze the frame.)
- ④
  - ◀◀ : Press to return to the beginning of the current chapter (track). Press repeatedly to return to the beginning of previous chapters (tracks).
  - ▶▶ : Press to advance to the beginning of the next chapter (track). Press repeatedly to advance to the beginning of following chapters (tracks).
- ⑤
  - ◀◀ : Hold down for fast reverse playback.
  - ▶▶ : Hold down for fast forward playback.
- ⑥ Press to start playback.

## LD player operations



Before to performing these operations, press the LD (SOURCE SELECT) button to switch the remote to the LD operation mode.

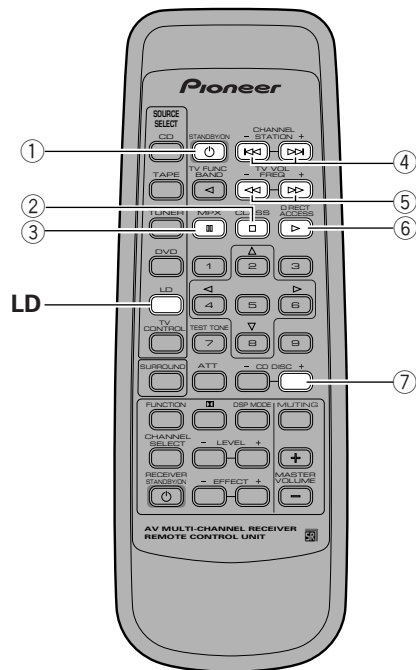

- ① Press to switch the LD player on or off.
- ② Press to stop playback. (With certain models, pressing this button when the unit is stopped may open the disc tray.)
- ③ Press to pause playback. (With certain models, this button may set still pictures.)
- ④
  - ◀◀ : Press to return to the beginning of the current chapter (track). Press repeatedly to return to the beginning of previous chapters (tracks).
  - ▶▶ : Press to advance to the beginning of the next chapter (track). Press repeatedly to advance to the beginning of following chapters (tracks).
- ⑤
  - ◀◀ : Hold down for fast reverse playback.
  - ▶▶ : Hold down for fast forward playback.
- ⑥ Press to start playback.
- ⑦ **CD DISC(+)**  
Switches between sides A and B of the disc.

### TV operations



Before to performing these operations, press TV CONTROL (SOURCE SELECT) to switch the remote to the TV operation mode.

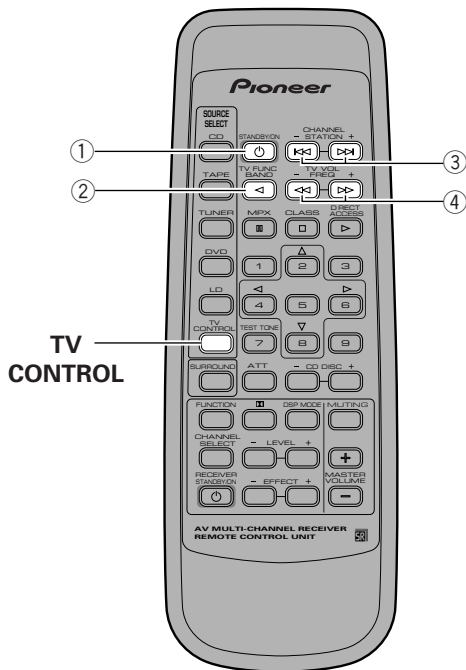

- ① Press to switch the TV on or off.
- ② **TV FUNC.**  
Press to switch the TV's input (not possible with all models). (This operation is possible regardless of the current remote operation mode.)
- ③ **CHANNEL (+/-)**  
Use to select a TV channel.
- ④ **TV VOL. (+/-)**  
Use to adjust the volume of the TV.



## CD player operations



Before to performing these operations, press the CD (SOURCE SELECT) button to switch the remote to the CD operation mode.

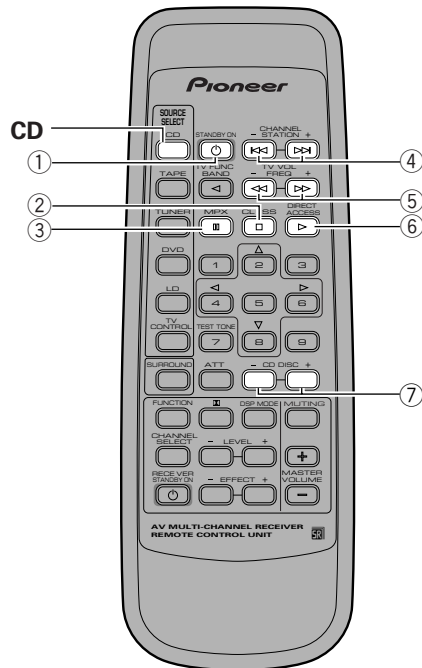

- ① Press to switch the CD player on or off.
- ② Press to stop playback.
- ③ Press to pause playback.
- ④ **◀◀**: Press to return to the beginning of the current track. Press repeatedly to return to the beginning of previous tracks.  
**▶▶**: Press to advance to the beginning of the next track. Press repeatedly to advance to the beginning of following tracks.
- ⑤ **◀◀**: Hold down for fast reverse playback.  
**▶▶**: Hold down for fast forward playback.
- ⑥ Press to start playback.
- ⑦ **CD DISC(+/-)**  
For multi-disc CD changers, use to select the disc numbers (not possible with all models).

Cassette deck operations



Before to performing these operations, press the TAPE (SOURCE SELECT) button to switch the remote to the TAPE operation mode.

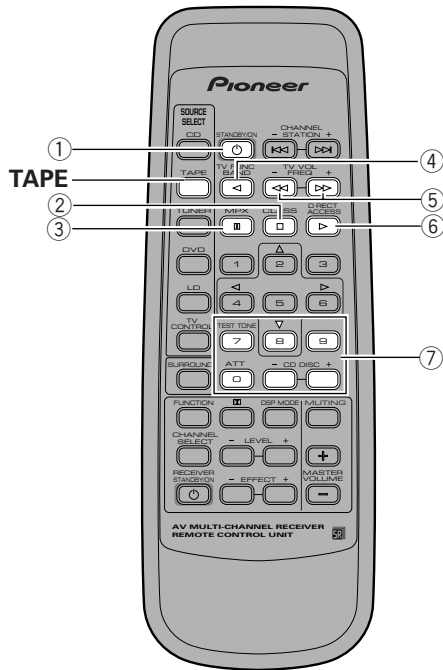

- ① Press to switch the cassette deck on or off (not possible with all models).
- ② Press to stop playback or recording.
- ③ Press to pause playback or recording.
- ④ Plays in the direction of the arrow.
- ⑤
  - : Press to rewind the tape. Hold down during playback for fast reverse playback (not possible with all models).
  - : Press to fast forward the tape. Hold down during playback for fast forward playback (not possible with all models).
- ⑥ Press to start playback.
- ⑦ **Number buttons**  
Use to operate deck 1 of a double cassette deck (not possible with all cassette decks).
  - 7 button** ()  
Plays in the direction of the arrow.
  - 8 button** ()  
Press to rewind the tape. Hold down during playback for fast reverse playback (not possible with all models).
  - 9 button** ()  
Press to fast forward the tape. Hold down during playback for fast forward playback.
  - 0 button** ()  
Press to fast forward the tape. Hold down during playback for fast forward playback.
  - CD DISC +** ()  
Press to start playback.
  - CD DISC -** ()  
Press to stop playback or recording.

## Dolby Digital

Dolby Digital is a compression format which records the sound of 6 channels of the theater surround system (Dolby Digital) on the movie film digital track. Of the 6 channels, the sub woofer channel is intended for bass only, and because the frequency range is smaller than the main channel, it is expressed as 5.1 channel.

Dolby Digital is the name of the Dolby surround multi-channel digital system that was developed after the Dolby Surround System and Dolby Pro Logic Surround System.

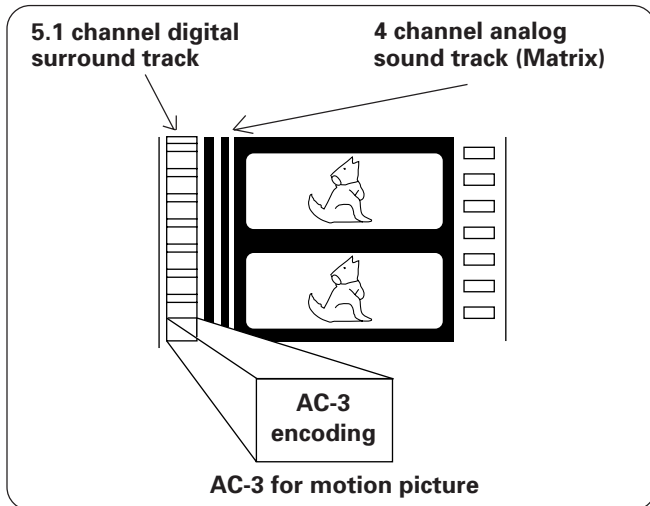

The number of movies made using Dolby Digital since 1992 has exceeded 300 and continues to increase. For compact disc players and laser disc digital sounds, 16 bits are used to sample the original analog audio waveform and sampling is carried out 44,100 times every second. However because an enormous amount of recording signal data is required for the multi channel system with this method, AC-3 is used to compress the data.

In reproducing audio signals, the smaller the bit number used, the lower the sound quality. With AC-3, drop in auditory sound quality is prevented by using masking technology and digital filtering technology based on the human auditory characteristics.

### Laser disc format

Laser discs are now available on the market in large numbers. This means that the recording of different format audio signals on the laser disc raises the important question of compatibility with existing laser discs. Dolby Digital tracks on Laser Discs record signals using the space of one analog audio channel so it will maintain compatibility with existing discs and players. As shown in the following figure, the digital audio sounds of Dolby Digital discs can be played back as currently done. Analog sounds are played back by using the other channel without the Dolby Digital signals for monaural audio signals.

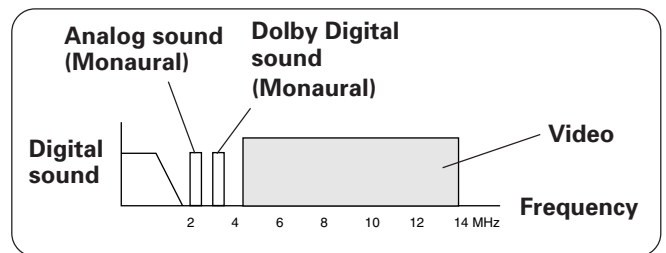

### Comparison with Dolby Pro Logic Surround

Dolby Digital is also known as the 5.1 channel system. It is equipped with 5 channels (front left, front right, center, surround left, surround right) in the frequency range from 20 Hz to 20 kHz and an independent Low Frequency Effect (LEF) channel. The sub woofer channel is also called Low Frequency Effect (LFE).

The subwoofer channel can be used as desired to enjoy strong bass sounds.



The following table shows the comparison with Dolby Pro Logic Surround effects.

	Dolby Digital	Dolby Pro Logic Surround
No. of recorded channels	5.1 channels (Max.)	2 channels
No. of playback channels	5.1 channels (Max.)	4 channels
Playback channel structure	Front Left, Front Right, Center, Surround Left, Surround Right, Sub Woofer	Front Left, Front Right, Center, Surround
Sound processing	Digital discrete processing	Analog matrix processing
Rear (Surround) high frequency playback limit	20,000 Hz	7,000 Hz
Other	<ul style="list-style-type: none"> <li>• 5.1 completely independent channels</li> <li>• High dynamic range</li> <li>• Stable position, high phase characteristics, and advanced surround effects reproduction</li> <li>• High efficiency (Compression rate of about one-tenth)</li> </ul>	

## Troubleshooting

Incorrect operations are often mistaken for trouble and malfunctions. If you think that there is something wrong with this component, check the points below. Sometimes the trouble may lie in another component. Investigate the other components and electrical appliances being used. If the trouble cannot be rectified even after exercising the checks listed below, ask your nearest PIONEER authorized service center or your dealer to carry out repair work.

Symptom	Cause	Remedy
The power does not turn ON.	<ul style="list-style-type: none"> <li>The power plug is disconnected.</li> <li>The protection circuit may have been activated.</li> </ul>	<ul style="list-style-type: none"> <li>Connect the power plug to the wall outlet.</li> <li>Disconnect the power plug from the outlet, and insert again.</li> </ul>
The unit does not respond when the buttons are pressed.	<ul style="list-style-type: none"> <li>Static electricity caused by dry air.</li> </ul>	<ul style="list-style-type: none"> <li>Disconnect the power plug from the outlet, and insert again.</li> </ul>
No sound is output when a function is selected.	<ul style="list-style-type: none"> <li>Improper connections.</li> <li>Sound is muted.</li> <li>The volume is turned down.</li> <li>The TAPE 2 MONITOR is ON.</li> <li>Speakers are turned OFF.</li> </ul>	<ul style="list-style-type: none"> <li>Make sure the component is connected correctly (refer to pages 9 to 13).</li> <li>Press MUTING on the remote control.</li> <li>Adjust MASTER VOLUME.</li> <li>Press the TAPE 2 MONITOR button.</li> <li>Press SPEAKERS (A/B) to select the speakers you connected.</li> </ul>
No image is output when a function is selected.	<ul style="list-style-type: none"> <li>Improper connections.</li> <li>The input source is not properly selected.</li> </ul>	<ul style="list-style-type: none"> <li>Make sure the component is connected correctly (refer to pages 10, 11).</li> <li>Press the correct function button.</li> </ul>
Considerable noise in radio broadcasts.	<ul style="list-style-type: none"> <li>Incorrect frequency.</li> <li>The antenna is not connected.</li> <li>AC-3 RF and/or digital cables are near the antenna terminals and wires.</li> </ul>	<ul style="list-style-type: none"> <li>Tune in the correct frequency.</li> <li>Connect the antenna (refer to page 8).</li> <li>Route AC-3 RF and digital cables away from the antenna terminals and wires.</li> </ul>
<b>FM broadcasts</b>		
	<ul style="list-style-type: none"> <li>The FM antenna is not fully extended or is poorly positioned.</li> <li>Weak radio signals.</li> </ul>	<ul style="list-style-type: none"> <li>Fully extend the FM wire antenna, position for best reception, and secure to a wall.</li> <li>Connect an outdoor FM antenna (refer to page 8).</li> </ul>
<b>AM broadcasts</b>		
	<ul style="list-style-type: none"> <li>The AM antenna is poorly positioned.</li> <li>Weak radio signals.</li> <li>Interference cause by other equipment (fluorescent lamp, motor, etc.).</li> </ul>	<ul style="list-style-type: none"> <li>Adjust the direction and position for best reception.</li> <li>Connect an additional internal or external AM antenna (refer to page 8).</li> <li>Turn off the equipment causing the noise or move it away from the receiver.</li> <li>Place the antenna farther away from the equipment causing the noise.</li> </ul>

Symptom	Cause	Remedy
Broadcast stations cannot be selected automatically.	<ul style="list-style-type: none"> <li>Weak radio signals.</li> </ul>	<ul style="list-style-type: none"> <li>Connect an outdoor antenna (refer to page 8).</li> </ul>
No sound from surround or center speakers.	<ul style="list-style-type: none"> <li>Speaker settings are incorrect.</li> <li>The rear and/or center levels are turned down.</li> <li>The surround and/or center speakers are disconnected.</li> </ul>	<ul style="list-style-type: none"> <li>Refer to "SPEAKER setting mode" on page 16 to check the speaker settings.</li> <li>Refer to "Adjusting the speaker volume" on page 20 to check the speaker levels.</li> <li>Connect the speakers (refer to page 13).</li> </ul>
Sound is produced from other components, but not from LD or DVD player.	<ul style="list-style-type: none"> <li>SIGNAL SELECT is set incorrectly.</li> <li>The digital inputs are assigned incorrectly, or not at all.</li> </ul>	<ul style="list-style-type: none"> <li>Set SIGNAL SELECT to "DIGITAL" or "ANAROG" according to the type of connections made. (refer to page 26)</li> <li>Set the digital input setting correctly (refer to page 15, 19).</li> </ul>
Cannot be remote controlled.	<ul style="list-style-type: none"> <li>The remote control batteries have worn out.</li> <li>Too far away or bad angle of operation.</li> <li>There is an obstacle between the receiver and the remote control.</li> <li>Strong light such as fluorescent light is shining onto the unit's remote control signal light-receiving window.</li> <li>A cord is connected to the CONTROL IN terminal on this unit.</li> </ul>	<ul style="list-style-type: none"> <li>Replace the batteries (refer to page 6).</li> <li>Operate within 23 feet (7 m), 30° of the remote sensor on the front panel (refer to page 7).</li> <li>Remove the obstacle or operate from another position.</li> <li>Avoid exposing the remote sensor on the front panel to direct light.</li> <li>Connect cord to the correct jack.</li> </ul>
The display is dark.	<ul style="list-style-type: none"> <li>This is not a malfunction.</li> </ul>	<ul style="list-style-type: none"> <li>In standby, pressing  STANDBY/ON while holding down the  button (both on the front panel) returns the display to the default brightness.</li> </ul>

**If the unit does not operate normally due to external effects such as static electricity**

Disconnect the power plug from the outlet and insert again to return to normal operating conditions.

## Specifications

### Amplifier Section

**Continuous average power output of 80 watts\* per channel, min., at 8 ohms, from 20 Hz to 20,000 Hz with no more than 0.09 %\*\* total harmonic distortion (front).**

#### Continuous Power Output

Front ..... 80 W + 80 W (1 kHz, 0.8 %, 8 Ω)  
 Center ..... 80 W (1 kHz, 0.8 %, 8 Ω)  
 Rear ..... 80 W + 80 W (1 kHz, 0.8 %, 8 Ω)

#### Input (Sensitivity/Impedance)

VCR, DVD/LD, TV/SAT, VIDEO, CD, MD/TAPE1, TAPE 2  
 ..... 200 mV/47 kΩ

#### Frequency Response

VCR, DVD/LD, TV/SAT, VIDEO, CD, MD/TAPE1, TAPE 2  
 ..... 5 Hz to 100,000 Hz  $\pm 0.3$  dB

#### Output (Level/Impedance)

VCR REC, MD/TAPE1 REC, TAPE 2 REC ..... 200 mV/2.2 kΩ

#### Tone Control

BASS ..... ± 6 dB (100 Hz)  
 TREBLE ..... ± 6 dB (10 kHz)  
 LOUDNESS ..... +9 dB/+7 dB (100 Hz/10 kHz)

#### Signal-to-Noise Ratio (IHF, short circuited, A network)

VCR, DVD/LD, TV/SAT, VIDEO, CD, MD/TAPE1, TAPE 2  
 ..... 97 dB

#### Signal-to-Noise Ratio [EIA, at 1 W (1 kHz)]

VCR, DVD/LD, TV/SAT, VIDEO, CD, MD/TAPE1, TAPE 2  
 ..... 80 dB

\* Measured pursuant to the Federal Trade Commission's Trade Regulation rule on Power Output Claims for Amplifiers.

\*\* Measured by Audio Spectrum Analyzer.

### VIDEO Section

#### Input (Sensitivity/Impedance)

VCR, DVD/LD, TV/SAT, VIDEO ..... 1 Vp-p/75 Ω

#### Output (Level/Impedance)

VCR, MONITOR ..... 1 Vp-p/75 Ω

#### Frequency Response

VCR, MONITOR ..... 5 Hz to 7 MHz  $\pm 0.3$  dB

Signal-to-Noise Ratio ..... 55 dB

Cross Talk ..... 55 dB

### FM Tuner Section

Frequency Range ..... 87.5 MHz to 108 MHz

Usable Sensitivity ..... Mono: 13.2 dBf, IHF (1.3 μV/75 Ω)

50 dB Quieting Sensitivity ..... Mono: 20.2 dBf

Stereo: 38.6 dBf

Signal-to-Noise Ratio ..... Mono: 73 dB (at 85 dBf)

Stereo: 70 dB (at 85 dBf)

Distortion ..... Stereo: 0.5 % (1 kHz)

Alternate Channel Selectivity ..... 60 dB (400 kHz)

Stereo Separation ..... 40 dB (1 kHz)

Frequency Response ..... 30 Hz to 15 kHz (± 1) dB

Antenna Input ..... 75 Ω unbalanced

### AM Tuner Section

Frequency Range ..... 530 kHz to 1,700 kHz

Sensitivity (IHF, Loop antenna) ..... 350 μV/m

Selectivity ..... 25 dB

Signal-to-Noise Ratio ..... 50 dB

Antenna ..... Loop antenna

### Miscellaneous

Power Requirements ..... AC 120 V, 60 Hz

Power Consumption ..... 280 W, 400 VA

Power Consumption in Standby mode ..... 2.5 W

#### AC Outlet

SWITCHED ..... 100 W (0.8 A) MAX

Dimensions ..... 420 (W) × 158 (H) × 391 (D) mm

16-9/16 (W) × 6-1/4 (H) × 15-3/8 (D) in

Weight (without package) ..... 9.8 kg (21 lb 10 oz)

### Furnished Parts

FM Antenna ..... 1

AM Loop Antenna ..... 1

Dry Cell Batteries (SIZE "AA" (IEC R6P)) ..... 2

Remote Control Unit ..... 1

Operating Instructions ..... 1

#### NOTE:

Specifications and the design are subject to possible modifications without notice, due to improvements.

---

Should this product require service in the U.S.A. and you wish to locate the nearest Pioneer Authorized Independent Service Company, or if you wish to purchase replacement parts, operating instructions, service manuals, or accessories, please call the number shown below.

**8 0 0 – 4 2 1 – 1 4 0 4**

Please do not ship your product to Pioneer without first calling the Customer Service Department at the above listed number for assistance.

PIONEER ELECTRONICS SERVICE, INC.  
CUSTOMER SERVICE DEPARTMENT  
P.O. BOX 1760, LONG BEACH,  
CA 90801-1760, U.S.A.

For warranty information please see the Limited Warranty sheet included with your product.



## Dear Customer:

Selecting fine audio equipment such as the unit you've just purchased is only the start of your musical enjoyment. Now it's time to consider how you can maximize the fun and excitement your equipment offers. This manufacturer and the Electronic Industries Association's Consumer Electronics Group want you to get the most out of your equipment by playing it at a safe level. One that lets the sound come through loud and clear without annoying blaring or distortion-and, most importantly, without affecting your sensitive hearing.

Sound can be deceiving. Over time your hearing "comfort level" adapts to higher volumes of sound. So what sounds "normal" can actually be loud and harmful to your hearing. Guard against this by setting your equipment at a safe level BEFORE your hearing adapts.

### To establish a safe level:

- Start your volume control at a low setting.
- Slowly increase the sound until you can hear it comfortably and clearly, and without distortion.

### Once you have established a comfortable sound level:

- Set the dial and leave it there.

Taking a minute to do this now will help to prevent hearing damage or loss in the future. After all, we want you listening for a lifetime.

## Power cord CAUTION!

Handle the power cord by the plug. Do not pull out the plug by tugging the cord and never touch the power cord when your hands are wet as this could cause a short circuit or electric shock. Do not place the unit, a piece of furniture, etc., on the power cord, or pinch the cord. Never make a knot in the cord or tie it with other cords. The power cords should be routed such that they are not likely to be stepped on. A damaged power cord can cause a fire or give you an electrical shock. Check the power cord once in a while. When you find it damaged, ask your nearest PIONEER authorized service center or your dealer for a replacement.

For Assistance With Basic Set-up, Operation, or Trouble Shooting, You May Contact Our Customer Service Hotline at 1(800)421-1404(USA ONLY)

## We Want You Listening For A Lifetime

Used wisely, your new sound equipment will provide a lifetime of fun and enjoyment. Since hearing damage from loud noise is often undetectable until it is too late, this manufacturer and the Electronic Industries Association's Consumer Electronics Group recommend you avoid prolonged exposure to excessive noise. This list of sound levels is included for your protection.

### Decibel

Level	Example
30	Quiet library, soft whispers
40	Living room, refrigerator, bedroom away from traffic
50	Light traffic, normal conversation, quiet office
60	Air conditioner at 20 feet, sewing machine
70	Vacuum cleaner, hair dryer, noisy restaurant
80	Average city traffic, garbage disposals, alarm clock at two feet.

### THE FOLLOWING NOISES CAN BE DANGEROUS UNDER CONSTANT EXPOSURE

90	Subway, motorcycle, truck traffic, lawn mower
100	Garbage truck, chain saw, pneumatic drill
120	Rock band concert in front of speakers, thunderclap
140	Gunshot blast, jet plane
180	Rocket launching pad

Information courtesy of the Deafness Research Foundation.



## Maintenance of External Surfaces

- Use a polishing cloth or dry cloth to wipe off dust and dirt.
- When the surfaces are dirty, wipe with a soft cloth dipped in some neutral cleanser diluted five or six times with water, and wrung out well, and then wipe again with a dry cloth. Do not use furniture wax or cleaners.
- Never use thinners, benzine, insecticide sprays or other chemicals on or near this unit, since these will corrode the surfaces.

Published by Pioneer Electronic Corporation.  
Copyright © 1999 Pioneer Electronic Corporation.  
All rights reserved.

**PIONEER ELECTRONIC CORPORATION** 4-1, Meguro 1-Chome, Meguro-ku, Tokyo 153-8654, Japan

**PIONEER ELECTRONICS [USA] INC.** P.O. BOX 1540, Long Beach, California 90801-1540

**PIONEER ELECTRONICS OF CANADA, INC.** 300 Allstate Parkway, Markham, Ontario L3R 0P2, Canada

**PIONEER ELECTRONIC [EUROPE] N.V.** Haven 1087, Keetberglaan 1, 9120 Melsele, Belgium TEL: 03/570.05.11

**PIONEER ELECTRONICS AUSTRALIA PTY. LTD.** 178-184 Boundary Road, Braeside, Victoria 3195, Australia, TEL: 03-9586-6300

**PIONEER ELECTRONICS DE MEXICO S.A. DE C.V.** San Lorenzo Num 1009 3er piso Desp. 302 Col. Del Valle, Mexico D.F. C.P. 03100 TEL: 5-688-52-90