



QUAD

L Series

Monitor Loudspeakers

Owner's Manual



QUAD

L Series

Monitor Loudspeakers

INTRODUCTION

QUAD L Series loudspeakers are true to the classic QUAD tradition of clear, uncoloured sound. No compromise has been made in quality of materials or workmanship. Although we naturally recommend that these speakers are partnered with QUAD amplification, they will enhance any quality sound system.

Please read the following notes carefully. They will help you to install your loudspeakers correctly and safely.

Switch off the amplifier and all sources before making connections to your sound system. When you switch on the system or change sources, set the volume control to minimum and turn up the level gradually.

The position of your Volume Control is NOT a reliable guide as to the maximum capabilities of your sound system. Playing the system with extreme settings of volume and tone controls may damage the amplifier and loudspeakers.

Do not connect loudspeaker terminals to the mains supply.

Ensure that your loudspeakers are correctly wired and are in phase.

Do not subject your loudspeakers to excessive cold, heat or sunlight.

WARNING: To reduce the risk of fire or electrical shock do not expose this product to rain or moisture. The product must not be exposed to dripping and splashing and no object filled with liquids - such as a vase of flowers - should be placed on the product.

No naked flame sources - such as candles - must be placed on the product.

Do not place heavy objects on top of loudspeaker cabinets. If you play the loudspeakers with the grilles removed be careful to protect the drive units from children and pets.

Do not use makeshift stands. Always fit a manufacturer's approved stand using the instructions and the fixings provided. Your dealer will advise you.

Do not attempt to dismantle the loudspeaker. There are no user serviceable parts inside and you will invalidate the warranty.

Site regular loudspeakers at least 0.5m away from TV sets and magnetic storage media. The Centre Channel loudspeaker is screened and may safely be operated close to a TV set.

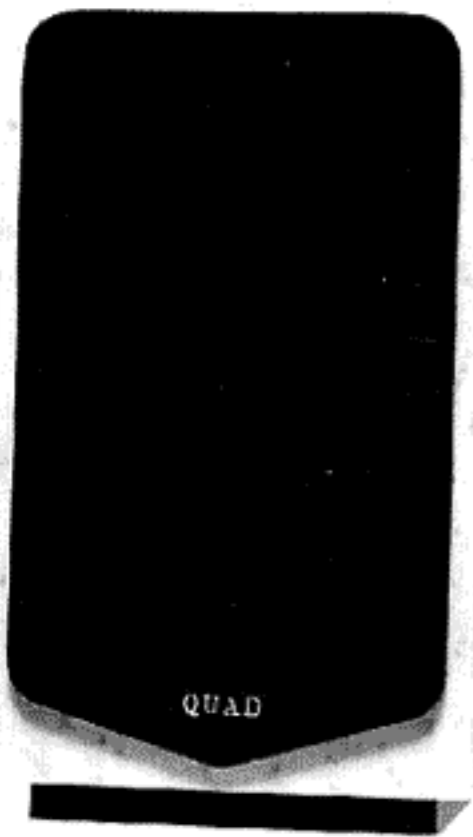

UNPACKING THE EQUIPMENT

Unpack the loudspeakers carefully. Be especially careful not to damage the loudspeaker cabinets when removing the polythene sleeves. Please retain the packing materials for future transportation. Retain the user manual and the information concerning the date and place of purchase of this equipment for future reference.

Quad 11L and 12L: These loudspeakers should ideally be stand mounted though they may be wall mounted or placed on a rigid shelf separate from the rest of the system.

Quad 21L and 22L: These models are floor standing and should be fitted with spikes for better stability and performance.

Fitting Spikes: Carefully invert the loudspeaker. Take care to protect the top surface from scratches or damage when the loudspeaker is in the inverted position. Each speaker is supplied with a set of four spike assemblies. Screw a spike into each of the pre-drilled holes in the bottom of each loudspeaker cabinet. Return the loudspeaker to its normal position taking care not to cause damage with the spikes. Adjust the spikes so that the speakers are stable. The top surfaces should be level and the same height above the floor.

When moving speakers, be particularly careful not to let the spikes pierce objects or cables which may be concealed under the carpet. Never drag the loudspeakers. If you cannot lift them easily, get someone to assist you.



Quad Centre Channel Loudspeaker: The loudspeaker is supplied with four self-adhesive feet. Peel off the backing material and attach a foot close to each corner on the bottom surface of the unit.

POSITIONING YOUR LOUDSPEAKERS

11L, 12L, 21L, 22L

We recommend that these loudspeakers are placed between two and three metres apart and equidistant from the listening position. The tweeters should be roughly at ear level to a seated listener. The loudspeakers should be positioned so that they are angled slightly inward, facing the listener.

The most uncoloured sound will be obtained when the loudspeakers are *at least* 200mm from the rear walls and 300mm from the side walls. If the loudspeakers are operated closer to the rear walls the bass extension will increase but if they are placed too close to the walls the bass may boom and become indistinct. If the loudspeakers are placed further away from the walls, the inward angle may be increased by up to 40%, although this may restrict the width of the optimum listening position.

As personal taste plays a large role, please experiment with different configurations and play a wide range of music before finalising the position of your loudspeakers.

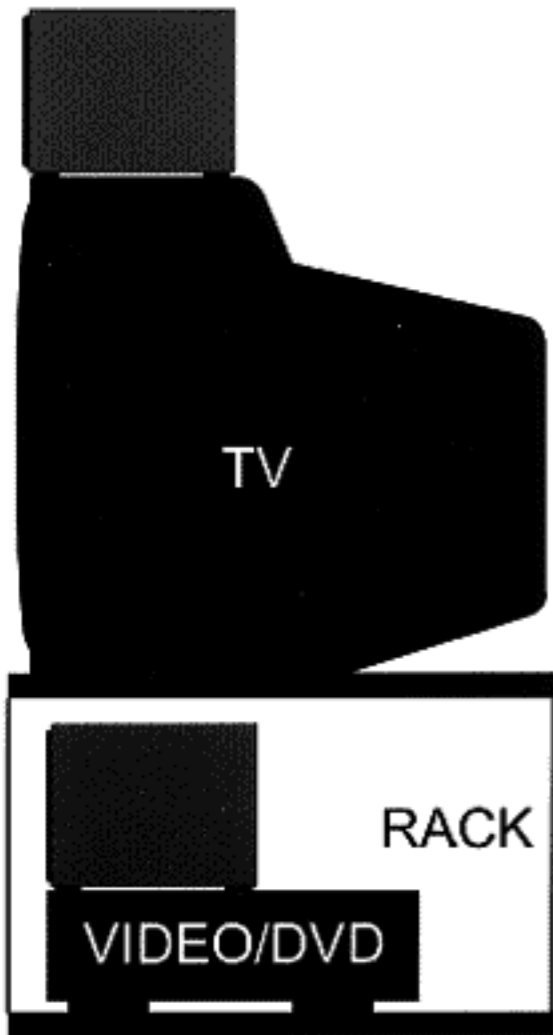

L- Centre

The loudspeaker should be positioned centrally between the loudspeakers close to the television and mounted either above or below the screen.

Locate the loudspeaker on a stable flat surface to avoid any danger of the cabinet moving when it is vibrated by high sound levels. If you mount the unit on top of the television, move it forward so that the front grilles are level with or slightly in front of the screen. This will reduce reflections from the screen and the top of the cabinet.

Although you may place the centre channel loudspeaker under the TV monitor, this should always be regarded as second best. The preferred position is always above the monitor, as shown.

CONNECTIONS AND TERMINALS

Crossover Network

Quad crossovers separate the treble and bass networks into two distinct sections, each connected by a dedicated pair of terminal posts. This enables the treble and bass components to be separately driven for optimum performance. The upper pair of terminals is connected to the treble network and the lower pair to the bass network.

As supplied, the treble terminal pair is connected to the bass terminal pair by removable metal straps. These should be left in place for standard installations.

Choosing and Preparing Cable

Specialist audio cable will usually offer better performance than general purpose 'bell' or 'zip' wire. Audio cable is polarised, with two cores of different colours, or often, in the case of twin cable, a coloured tracer or ridge along one wire to indicate polarity.

Choose a cable of suitable diameter - cable that is too thin will limit the dynamics of the sound and may impair the bass response. Split the twin cores to a depth of about 40mm. Carefully strip the insulation from each end, leaving about 10mm of bare wire. If the cable is stranded, lightly twist to gather any loose strands.

Connecting Speaker Terminals

Unscrew the terminal. Thread the bared end of each cable through the hole in the bottom of the terminal post. Ensure that there are no loose strands which may touch adjacent terminals. Retighten the terminal securely.

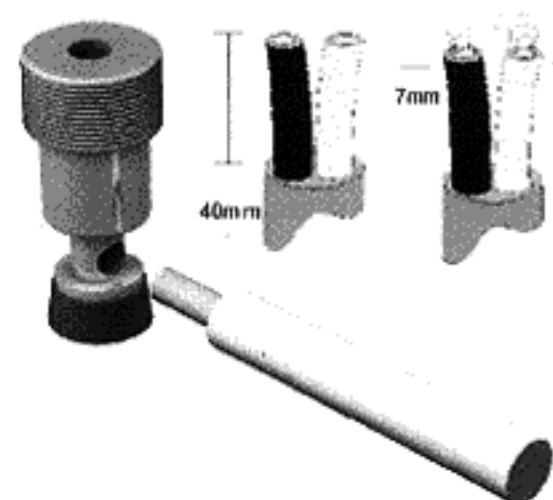
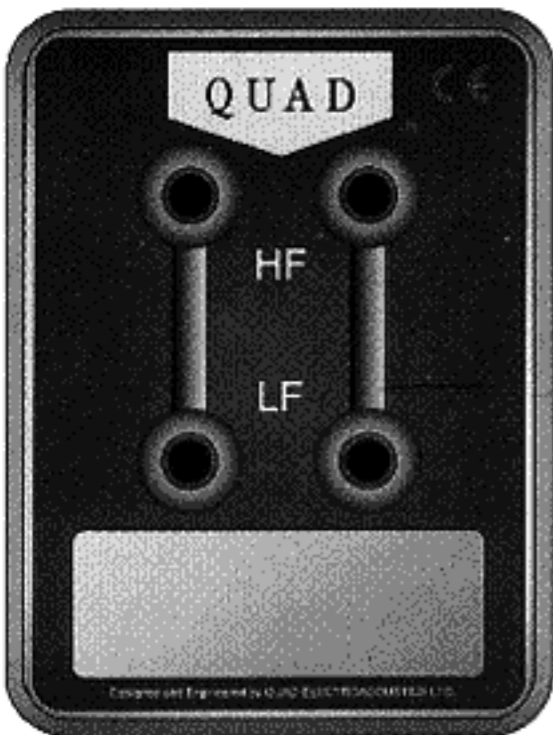

CONNECTING THE LOUDSPEAKERS - 11L, 12L, 21L, 22L

Standard Connections

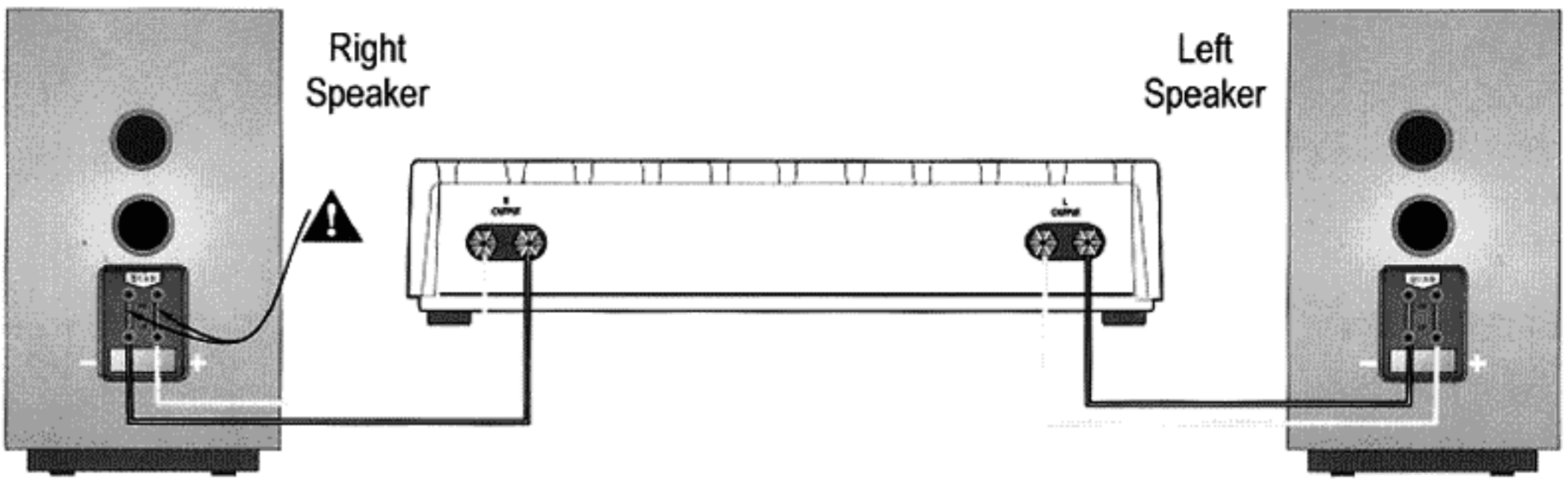

Choose a suitable length of twin core speaker cable for each channel, and prepare the ends as described above.

Connect the positive(+) terminal of the Left loudspeaker to the corresponding positive(+) amplifier terminal. Connect the negative(-) terminals similarly. Repeat this procedure for the Right Channel. Note that the positive(+) terminals are located on the right.

You may connect to either the upper or lower pair of terminals.

Bi-Wiring

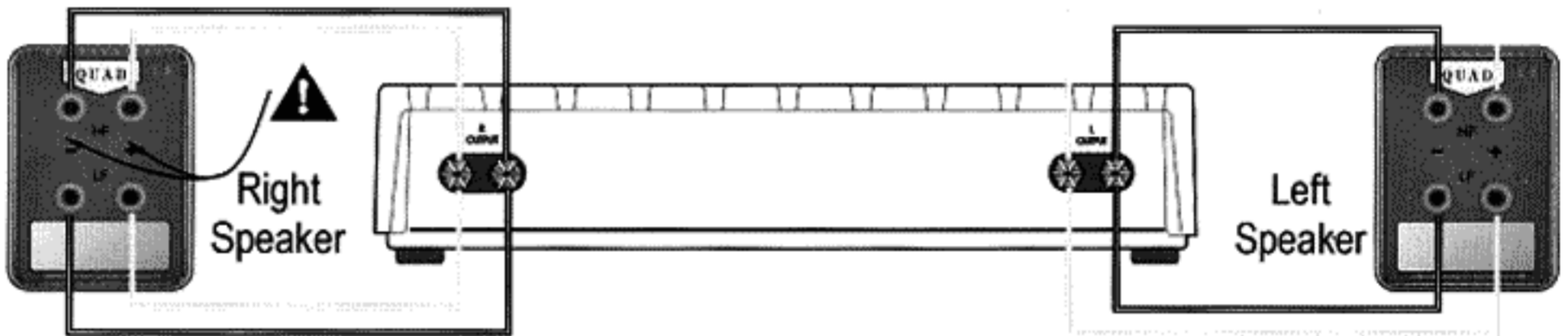

Most of the audio signal going to the speakers drives the bass units. Where one cable feeds both bass and treble units, this heavy bass current can modulate the high frequencies. Using separate cables for treble and bass units reduces intermodulation effects and improves headroom and clarity. This technique of wiring is known as Bi-Wiring. To bi-wire, you will need to install two lengths of twin core cable between the amplifier and each loudspeaker.

Unscrew each terminal a few turns and remove the metal straps. The upper pair of terminals on the crossover panel feeds the treble units and the lower terminals feed the bass unit. Connect the cables between the amplifier and the loudspeakers as indicated above and re-tighten all the terminals securely.

Where feasible, we strongly advocate bi-wiring.

Bi-Amplifying (Bi-Amping)

By connecting each loudspeaker drive unit to its own dedicated amplifier the advantages of Bi-Wiring can be extended. If you own two identical stereo power amplifiers, you may wish to try bi-amping your QUAD loudspeakers. For further details please consult your dealer.

CONNECTING EFFECTS LOUDSPEAKERS

The Quad L-Centre is a dedicated centre channel loudspeaker, voiced to blend seamlessly with the other loudspeakers in the L Series, though it can be used with any high performance loudspeakers, including Quad Electrostatics.

When partnered with either the Quad 21L or 22L as the Front channels, and the Quad 11L or 12L as Rear Effects channels, a Home Theatre system of outstanding performance can be built up.

The connections for a typical Home Theatre system are shown on the next page.

We suggest that the Front and Centre Channels are bi-wired. The rear effects speakers should be connected using the standard connection as described above, though you may bi-wire them if you prefer.



HOME THEATRE LOUDSPEAKER CONNECTIONS

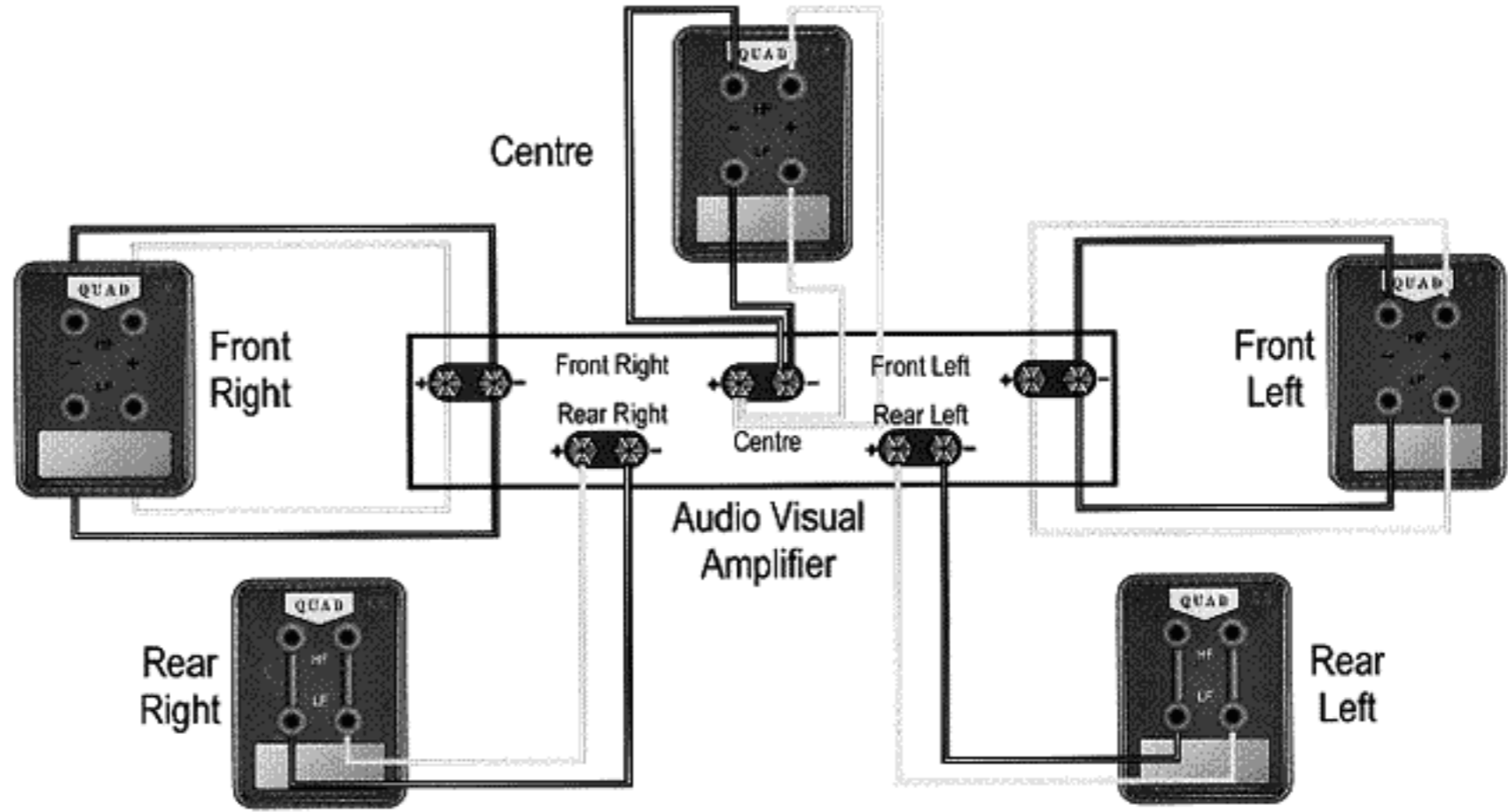

SETTING LOUDSPEAKER SIZES IN HOME THEATRE SYSTEMS

Many digital AV Processors require you to specify the size of speakers in all channels. These are usually Large or Small.

Always choose 'Small' for the Surround channels and Centre channel whether you are using a subwoofer or not.

If you are not using a subwoofer: Set the Front Speakers to Large. Set the Subwoofer option on the processor to Off or No. The Front channels will now receive all the system bass.

If you are using a subwoofer: When set to Small all the system bass will go into the subwoofer. If you choose Large the Front channel bass will be reproduced from the Front speakers. Bookshelf speakers should be set to Small, large floor standing units may be set to Large.

Refer to your A/V processor manual for details on setting up your Home Theatre system.

GETTING THE BEST FROM YOUR LOUDSPEAKERS

Phase

If the sound lacks definition or the bass is indistinct, this could be because you have inadvertently mis-connected your loudspeakers. Please check the wiring to all the loudspeakers carefully, especially if they are bi-wired.

Ancillary Equipment

QUAD loudspeakers are compatible with the great majority of audio-visual and high fidelity equipment - but a loudspeaker is only as good as the signal it gets. Your amplifier should have ample reserves of power - a low powered amplifier can run out of steam and the resulting distortion is unpleasant to listen to and could damage your speakers. A larger amplifier will usually sound better *and* enhance the reliability and performance of your loudspeakers.

Running In

Loudspeakers are electro-mechanical and, like all mechanical systems, they need a 'running in' period. For the first 50 hours or so exercise care and play your system at reasonable volume levels. After running in, you will notice a significant sonic improvement.

Care and Maintenance

Little maintenance is required. The cabinets can be occasionally wiped with a damp (not wet) cloth. Spray polish, if used, should be applied sparingly - spray the polish onto a cloth and then apply it to the speaker. NEVER spray the grille cloth or the speaker drive units. To clean the grilles, remove them first before gently brushing with a soft brush. Never use solvent cleaners, minor stains are best removed with soap and lukewarm water.

Avoid touching the drive units as they can easily be damaged.



SERVICE & INFORMATION

Product service enquiries should, in the first instance, be referred to the supplying dealer. If you need to return your loudspeakers for servicing, please return them as a pair, where appropriate, even if only one unit appears to be faulty. For safety, we suggest you ship them in their original packing.

In cases of difficulty or for other product enquiries please contact the appointed QUAD distributor for your country. Service Centres in the UK and North America can be found below.

Authorised QUAD Service Centres in the U.K. and North America

USA	U.K.	CANADA
IAG America, Inc. 15 Walpole Park South Walpole MA 02081 Tel: +1 508 850 3950	QUAD Electroacoustics Ltd. IAG House, Sovereign Court, Ermine Business Park, Huntingdon, Cambs PE29 6XU, England. Tel:+44 (0)1480 447700 Fax:+44 (0)1480 431767	Korbon Trading Ltd 6800 Kitimat Road Units 19-20 Mississauga Ontario Tel: +1 905 567 1920

For information on authorised service centres worldwide contact QUAD Electroacoustics Ltd.. A worldwide distributor list is available on the QUAD website: www.quad-hifi.co.uk

SPECIFICATIONS:

FRONT LOUDSPEAKERS	QUAD 11L	QUAD 12L	QUAD 21L	QUAD 22L
Bass Unit	125mm	170mm	170mm	170mm
Bass/Midrange Unit				170mm
Treble Unit	25mm Dome	25mm Dome	25mm Dome	25mm Dome
Rec. Amplifier Power	30 - 150 W	30 - 200 W	30 - 200 W	30 - 300 W
Nominal Impedance	6 Ohms	6 Ohms	6 Ohms	6 Ohms
Sensitivity (2.83V @ 1M)	86 dB	88 dB	88 dB	89 dB
Frequency Response	45Hz - 24kHz	45Hz - 24kHz	40Hz - 24kHz	30Hz - 24kHz
Frequency Fb	55Hz	50Hz	40Hz	35Hz
Size mm (H x W x D)	325x190x243	345x205x253	780x205x263	850x205x278

L-CENTRE LOUDSPEAKER

Bass Unit	125mm
Treble Unit	25mm Dome
Rec. Amplifier Power	30 - 150 W
Nominal Impedance	6 Ohms
Sensitivity (2.83V @ 1M)	88 dB
Frequency Response	70Hz - 24kHz
Frequency Fb	60Hz
Size mm (H x W x D)	428x162x206

Quad loudspeakers are compatible with most 4 and 8 Ohm amplifiers

The name QUAD is a registered trademark of International Audio Group Limited.
QUAD has a policy of continuous product development and reserves the right to change specification without notice.

Quad Electroacoustics Ltd, IAG House,
Sovereign Court, Ermine Business Park,
Huntingdon PE29 6XU
www.quad-hifi.co.uk
Tel: 01480 447700 Fax: 01480 431767