

POCKET-SCAN FM Monitor Receiver

Dual Band: 30-50 & 148-174 MHz

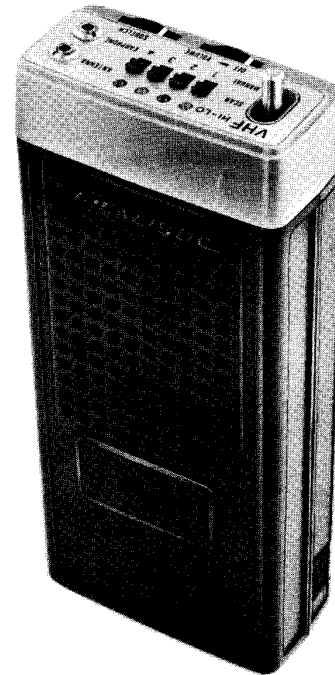

PRO-46

OWNER'S
MANUAL

REALISTIC

CUSTOM MANUFACTURED FOR RADIO SHACK  A TANDY CORPORATION COMPANY

RADIO SHACK  A TANDY CORPORATION COMPANY

U.S.A.: FORT WORTH, TEXAS 76107

CANADA: BARRIE, ONTARIO, CANADA L4M 4W5

TANDY CORPORATION

AUSTRALIA

280-316 VICTORIA ROAD
RYDALMERE, N.S.W. 2116

BELGIUM

PARC INDUSTRIEL DE NANINNE
5140 NANINNE

U. K.

BILSTON ROAD
WEDNESBURY, STAFFS WF10 7JN

Your **REALISTIC Pocket-Scan PRO-6 Scanning Receiver** is a super compact solid-state Dual-Band VHF, dual-conversion super-heterodyne receiver, capable of automatically scanning 4 crystal controlled channels. Some special features are: two ceramic filters, channel lock-out circuit, skipper circuit and EXTERNAL DC POWER jack for operation from an external source of 6-volts DC. The Pocket-Scan is intended to be used by Civil Defense personnel, professional or part time public servants (police, firemen, etc.), or just anyone interested in listening to the exciting action constantly taking place on the air waves in your locality.

It is designed for use in the narrow-band FM channels of Public Service communications: VHF band Police, Fire, Civil Defense, Radio Telephone, Forestry and weather service, plus many other Industrial Radio Services. These and many other services share this band of frequencies from 30 to 50 MHz and 148 to 174 MHz.

The PRO-6 features both high sensitivity and selectivity and a sophisticated circuit which includes 10.7 MHz and 445 kHz ceramic filters to reduce or eliminate adjacent channel or strong-signal interference. Such interference is often experienced when operating in urban and metropolitan areas or where very strong and closely placed signals are present.

The PRO-6 represents some rather complex engineering and manufacturing achievements, but is designed for very practical applications. And still, it is remarkably easy to use. It can be placed in your pocket, clipped to your belt, or operated in your home, office or vehicle. You'll be amazed to realize that this small package contains densely packaged circuitry composed of 27 transistors, two integrated circuits (which incorporate the equivalent of hundreds of components), 17 diodes and 4 Light Emitting Diodes (LED's) for the scanning indicators.

Your local Radio Shack store has a complete line of accessories for use with the PRO-6—extra batteries, power adapters, cables, crystals, antennas, etc.

GUARANTEE: The RADIO SHACK guarantee is stated on the Guarantee card packed with the unit. It is in effect from coast-to-coast. At any time, RADIO SHACK equipment can be restored to like-new condition with original parts, with minimum delay, anywhere in the U.S.A., normally right in your own neighborhood. In 98% of the cases, it is **not** necessary to return RADIO SHACK equipment to our laboratories.

WARNING

The PRO-6 is designed to operate from four penlight (AA) batteries (connected in series), or an external source of +6 volts DC (**negative ground**). If it fails to operate, and there is no clear reason for the failure, first check the batteries. Before you try connecting the PRO-6 receiver to an external 6-volt DC power supply, check the voltage polarity. Attempting to operate the negative ground PRO-6 from a POSITIVE GROUND electrical system, may damage it. The Radio Shack warranty does not apply to any damage caused by improper power connections or other damage caused by misuse, damage or neglect.

SPECIFICATIONS

CHANNELS OF OPERATION:	Four—as determined by any one of 4 crystals operating in the frequency range
FREQUENCY RANGE:	30 to 50 MHz and 148 — 174 MHz
FREQUENCY COVERAGE:	(Lo) 6 MHz for maximum sensitivity (40 MHz \pm 3 MHz) (Hi) 8 MHz for maximum sensitivity (153 MHz \pm 4 MHz)
SENSITIVITY:	Better than 1 microvolt for 20 dB quieting
SELECTIVITY:	\pm 13.5 kHz, -6 dB \pm 20 kHz, -50 dB
MODULATION ACCEPTANCE:	\pm 7 kHz
IF. FREQUENCY:	10.7 MHz and 455 kHz
FILTER:	10.7 MHz and 455 kHz Ceramic Filters
SQUELCH SENSITIVITY:	Variable from less than 1 microvolt
SCANNING SPEED:	6 channels/second
DELAY TIME:	0.7 to 1.5 seconds
AUDIO POWER:	150 milliwatts
POWER REQUIREMENTS:	+6 volts DC (negative ground only) Current drain: 40 to 100 mA (no signal/squelched, to full volume)
SEMICONDUCTOR COMPLEMENT:	2 Integrated Circuits 27 Silicon Transistors 17 Diodes 4 Light Emitting Diodes (LED's)
SPEAKER:	2", 16 ohm, Permanent Magnet, dynamic type
ANTENNA:	Built-in wire loop, plus external whip-type wire
CRYSTAL REQUIREMENTS:	Standard HC-25/u 3rd overtone

PREPARING FOR USE

To use your POCKET-SCAN, you must do two things:

Install the batteries

Install 1, 2, 3 or 4 crystals

To install the batteries; turn the receiver face down and press in firmly on both sides of the receiver at the place marked BATTERY PACK and lift the compartment up and away.

Remove the battery pack. Insert four AA batteries, one at a time making sure the polarity markings inside the battery pack match up (+ to + and - to -) with markings on the batteries.

We recommend Nickel Cadmium AA batteries, Radio Shack Catalog Number 23-125, or AA NOVA CELL, Catalog Number 23-453 be used in your new Receiver.

Press the Battery Pack into place (press sides of Battery Pack inward to snap it back onto the case).

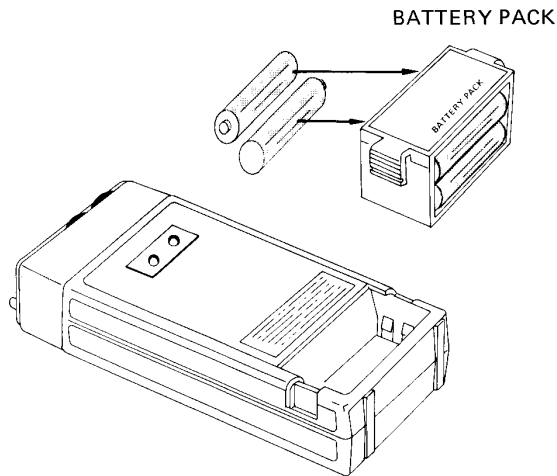

Crystals are not included with your POCKET-SCAN because the frequencies are so numerous. The frequencies used in your part of the country will be different from those used in other areas. Your Radio Shack Store Manager will advise you as to what frequencies are most used and help you in your selection of crystals.

Remove the Crystal Compartment Cover by sliding it to the left and insert crystal into the crystal socket (Lo or Hi). Provision is made to install 4 crystals; each position can be used for either VHF Hi or VHF Lo. Follow the illustration provided for proper installation of each crystal.

For VHF Lo crystals, use the center and lower crystal socket holes.

For VHF Hi crystals, use the center and upper crystal socket holes.

In the example shown, Channel 1 will have a VHF Lo crystal and Channel 4 will have a VHF Hi crystal.

CRYSTAL COMPARTMENT COVER

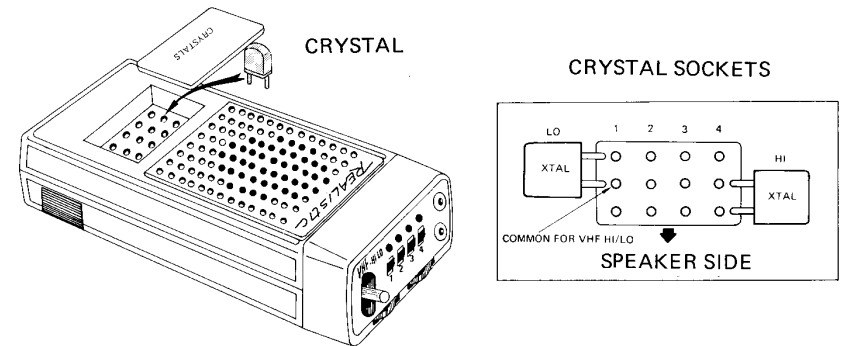

Since crystal frequencies must be extremely accurate and crystals should be matched for specific units, we recommended you obtain crystals for your POCKET-SCAN only from Radio Shack. Be sure to specify the Catalog Number and Model description of your Monitor Receiver. We can not be responsible for the poor or improper operation of crystals from another manufacturer(s).

CONTROL LOCATION AND FUNCTION

OFF-VOL is the power switch and Volume control. When not in use, rotate this control to the left to turn it off.

SQUELCH control is to eliminate annoying background noise between signal transmissions. When properly set, Squelch will keep the PRO-6 silent until a signal comes in on the channel(s) you are listening to—then, the Squelch circuit will “open” and you hear the signal.

Selector Switch is for determining the function of the scanning feature. In the SCAN position, each channel will be scanned automatically. In the center (stop) position, the PRO-6 will not scan, but will remain tuned to the channel indicated by the LED. To advance the receiver to the next channel in sequence, press to the MANUAL position momentarily; each time you do so, the receiver will advance one channel.

Channel Lock-out Switches—in the “up” position (button next to the LED), that channel is active. When you press the switch down, that channel is automatically “locked out” and will not function.

LED Channel Indicator—these Light Emitting Diodes show which channel(s) is active. During scanning, these lights light up in sequence; when the receiver is operative on one of the channels, the light for that channel will go on. When the Channel Lock-out switch for that channel is in the down position, that LED will not light.

EARphone jack is for plugging in the earphone. Use it for private listening or in areas where background noise is excessive (in factories, at the scene of an accident or fire, in a vehicle, etc.).

ANTenna jack is for connecting an external antenna to the PRO-6. You can use either the wire antenna provided or an outside VHF antenna.

Belt Clip is provided so you can attach the PRO-6 to your belt or other convenient place.

Battery Compartment holds internal power source (4 type AA batteries).

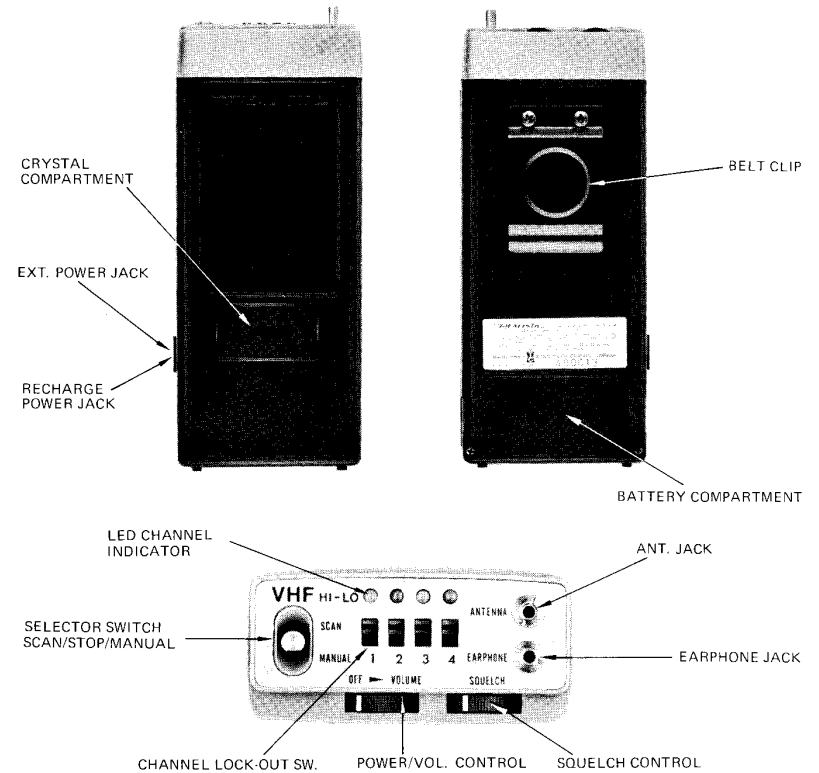

Crystal Compartment contains crystals selected for operation.

EXTERNAL Power and Battery Charge Jack—The EXT POWER JACK is for connecting an external source of 6 volts DC (negative ground), so that operation without the use of batteries is possible.

NOTE

The **RECHARGE POWER JACK** is to be used only when Nickel Cadmium batteries are installed in the receiver.

To recharge Nickel Cadmium batteries in the receiver, simply plug an external 6-volt DC power source into the **RECHARGE POWER JACK**.

OPERATION

After batteries and a crystal (or crystals) has been installed, your PRO-6 is ready to use.

Turn **VOLUME** "on" by rotating to the right. Rotate **SQUELCH** to the minimum position by rotating to the left. Set all the **Channel Lock-out Switches** "on" (in the up position, toward the LED indicators). You should hear a rushing sound from the speaker. Now adjust **SQUELCH** to the right until you reach the point where the rushing background noise abruptly stops.

If you want the PRO-6 to continuously scan the channels for which you have crystals installed, you must adjust **SQUELCH** as previously instructed, then set the **Selector Switch** to the SCAN position. The PRO-6 will constantly scan each channel in sequence; when a signal appears on one of the channels the receiver will lock onto that channel and you will hear the signal.

If you do not want automatic scanning on one or more channels, switch their **Channel Lock-out Switches** to the "off" position (down or away from the LED indicator).

If you want to stay tuned to one channel only, set the **Selector Switch** to the center position (stop scanning) and then press to the MANUAL position to advance to the channel you want to listen to (as indicated by the LED above that channel switch). For MANUAL scanning, the receiver can be either "squelched" (adjusted as previously indicated) or "unsquelched" (**SQUELCH** control set to extreme left). For AUTOMATIC scanning, **SQUELCH** must be set to eliminate the background noise.

To eliminate the annoying background noise, rotate **SQUELCH** toward the right until the background noise abruptly stops. You can't adjust **SQUELCH** properly while listening to a station, so wait until signals cease. If you set **SQUELCH** as noted above, the PRO-6 will appear "dead" until a signal comes in; when a signal comes in, the Squelch circuit "opens up" and you hear the signal. When the signal ceases, the Squelch circuit "closes" and cuts out all sound until the next signal comes in.

The PRO-6 has a built-in loop antenna and in high level signal areas you may not need another antenna. However, in most cases, you will want to use the wire antenna provided; just plug it into the **ANTenna Jack** and extend the antenna vertically. For the very best reception, you will want to use an outside antenna—see the ANTENNAS section.

ANTENNAS

For superior reception, you will want to use an external antenna such as Radio Shack Catalog Number 20-015. This antenna is designed for base station operation. If you intend to use your POCKET-SCAN in a vehicle, we recommend Catalog Number 20-016. You will need coaxial cable to connect between the base station antenna and the POCKET-SCAN—use Catalog Number 278-970 (50 feet of RG-8/U). At the POCKET-SCAN, use a sub-miniature phone plug on the end of the coax cable (274-289) or a combination of adapters which will mate into a male sub-miniature plug.

For mobile use, you can mount the POCKET-SCAN permanently or temporarily. In either case, be sure it is positioned (along with its cables) in a safe and convenient location. When you mount a mobile antenna, keep the following points in mind:

1. Mount the antenna as high as possible—the center of the roof is best.
2. It should be rigid, so it will be vertical when in motion.
3. Keep it as far as possible from the engine compartment (the engine is a source of noise, which will interfere with reception).

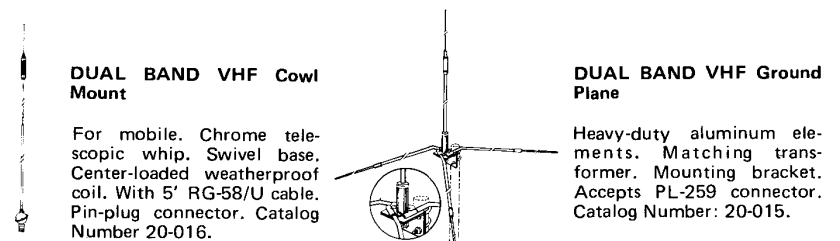

FREQUENCY COVERAGE

For maximum sensitivity, the channel frequencies you choose should be within 3 MHz of 40 MHz on the LO VHF band (that is, in the spread of 37 to 43 MHz). For the HI VHF band, stay within 4 MHz of 153 MHz (that is, 149 to 157 MHz). This Receiver will function very adequately down to 30 and up to 50 and from 148 to 175 MHz, but with reduced sensitivity. The superior reception spread of 6 or 8 MHz ($\pm 3/4$ MHz) can be moved up or down in this band of frequencies by special realignment of the front end circuitry of this Receiver (which should be attempted only by qualified Electronics Service Technicians who have adequately calibrated, precision test equipment).

With such realignment, your Receiver can tune signals in the Ham bands and other services. We call your attention to the fact that this Receiver is designed for reception of FM signals and thus can not be used for monitoring AM signals (even though they may be within the frequency coverage range). These AM signals include much of the aircraft services.

TYPES OF SIGNALS YOU'LL BE ABLE TO MONITOR

Your community is alive with action—action which is constantly being reported on the air waves. And your PRO-6 will automatically scan the air waves to bring you that action—your police force at work, a fire truck on a mission, Ham Radio operators, highway and other emergency-type services, some industrial services, some transportation services (taxi, trucks, railroad), plus some Government services. Lots of things are going on that most of us just are never aware of. But, with the right frequency crystal in your PRO-6 you can monitor such exciting signals. You'll have to do a little investigating in your community to find out what services are active and on what frequencies. You will find one of our books to be very interesting and helpful in this area: **REALISTIC GUIDE TO POLICE, FIRE AND AIRCRAFT RADIO.**

What to listen for and where? That is a little difficult for a specific answer. Each area of the country can and will use different frequencies. All we can do is give you some general pointers and let you take it from there.

Find out if there is a local club which monitors these frequencies. Often a local electronics repair shop that does work on the equipment can give you the channel frequencies used by local radio services. A volunteer police or fire employee can also be a good source of this information.

An interesting service is the Mobile Telephone. FCC has assigned this service channels in the range of 152.51 to 152.81 MHz at every 0.030 MHz (channels are 30 kHz apart).

As a general rule on VHF, most activity will be concentrated between 153.785 and 155.98 and then again from 158.73 to 159.46 MHz. Here you'll find local government, police, fire and most such emergency services. If you are near a railroad yard or major railroad tracks, look around 160.0 to 161.9 MHz for them.

NATIONAL WEATHER SERVICE RECEPTION

Continuous weather broadcasts are transmitted 24-hours-a-day in many parts of the country. If you are using a crystal set to one of the two channels assigned (162.55 or 162.40 MHz), your Receiver will automatically lock-in on that channel, since the broadcasts are continuous. To prevent automatic locking, set the channel lock-out button for that channel to the "off" position (button out). When you want a weather report, set the Lock-Out Button to the "on" position (press in) for that channel. In areas where two stations are close to each other, one will use 162.55 and the other will use 162.40 MHz. Check with your local FCC office or the Weather Bureau for the frequency used in your area.

ACCESSORIES

Your PRO-6 can be powered from any source of 6 volts DC, negative ground. Using an AC adapter will save on batteries; so, if you intend to use the PRO-6 in a location where 120 volts is readily available, and it does not need to be moved around, consider an adapter. Radio Shack has two power adapters which you might be interested in. Catalog Number 270-1531 is a universal adapter for 120 volts AC, to provide 4.5/6/7.5/9 volts DC (positive or negative). Catalog Number 270-1532 is a power adapter for plugging

into a cigarette lighter socket in your vehicle and providing either 6 or 9 volts DC (positive or negative). This will permit you to use the PRO-6 in your car or truck without wearing down your batteries. Of course, with such an adapter you can recharge Nickel Cadmium batteries by using the RECHARGE POWER JACK.

MAINTENANCE

The PRO-6 is a ruggedly built electronic unit, with all parts conservatively rated. However, you should treat it with care; don't subject it to excessively rough handling. You will find it will give you long life if kept free from dirt and excessive humidity.

If the sound becomes weak and distorted, it is time for new batteries. We recommend Radio Shack Alkaline batteries, Catalog Number 23-552. Or, use our ENERCELL rechargeable batteries (23-125)—you can recharge them hundreds of times. If you do not intend to use the PRO-6 for a few weeks, it is best to remove the batteries. Also, never leave weak or dead batteries in the unit.

BLOCK DIAGRAM

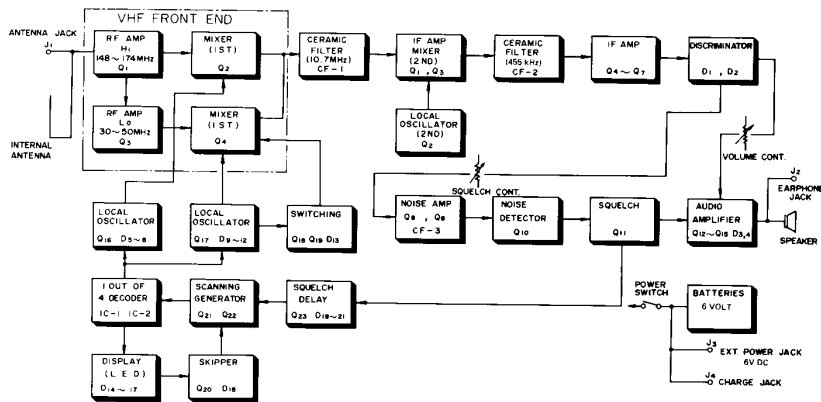

SCHEMATIC DIAGRAM

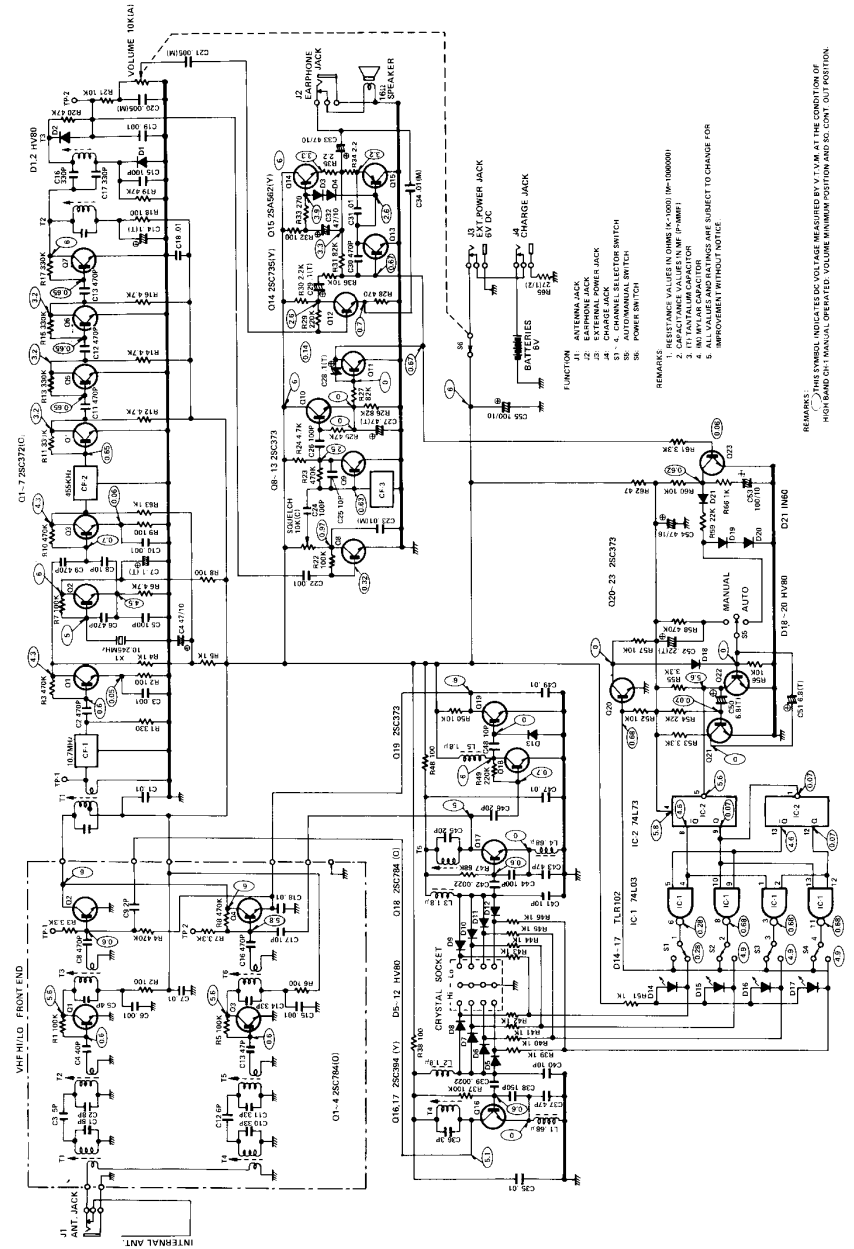

SCHEMATIC DIAGRAM

