

Equipment profiles

Realistic Model STA-2000 Stereo Receiver



62

MANUFACTURER'S SPECIFICATIONS

FM Tuner Section

IHF Sensitivity: 1.7 μ V (9.8 dBf).
Signal-to-Noise Ratio: Mono, 70 dB.
Image Rejection: 80 dB.
Capture Ratio: 1.5 dB.
THD, 1 kHz: Mono, 0.2 per cent; stereo, 0.3 per cent.
I.F. Rejection: 80 dB.
AM Suppression: 55 dB.
SCA Rejection: 75 dB.
Stereo Separation, 1 kHz: 48 dB.

AM Tuner Section

Sensitivity: External antenna, 10 μ V; internal antenna, 150 μ V/M.
THD: 1.2 per cent.
Image Rejection: 60 dB.
I.F. Rejection: 56 dB.

Amplifier Section

Power Output: 75 watts continuous power per channel, 8 ohm loads, from 20 Hz to 20 kHz.
Rated THD: 0.25 per cent.
Frequency Response: 15 Hz to 20 kHz.

Input Sensitivity: Phono, 2.2 mV, High Level, 140 mV.

Phono Overload: 230 mV.

S/N Ratio: Phono, 70 dB; high level, 75 dB.

Tone Range Control: Bass, ± 10 dB @ 100 Hz; treble, ± 10 dB @ 10 kHz.

General Specifications

Power Requirements: 120 V, 60 Hz, 550 watts maximum.

Dimensions: 19 $\frac{1}{4}$ in. (48.9 cm) W x 6 $\frac{1}{4}$ in. (15.8 cm) H x 16 $\frac{1}{2}$ in. (41.9 cm) D.

Price: \$499.95.

The people at Radio Shack seem quite determined to find a place for themselves in the audiophile section of the market, and with the introduction of their latest series of stereo receivers, they have to some degree succeeded. Never ones for spelling out a long list of technical specifications, the Radio Shack folks appear, from the published specs given above, to have partially changed their feelings about the common practice of detailing at least the most important technical specifications associated with their new, top-of-the-line, powerful receiver, the Model STA-2000. While the list of specs is not as complete as those from some other makers, and no attempt has been made to conform to the newly established IHF/IEEE/EIA Tuner Measurement Standards, we can overlook the omissions in light of the actual

performance capabilities, design, and layout of the finished product itself.

The front panel of the receiver is styled like many other new receivers, in that it is all one color (gold) with a highly visible, centrally located dial area which extends almost the full width of the panel. FM frequency markings are linear, calibrated at every half MHz, and there is a 0 to 100 logging scale centered between the upper FM scale and AM frequency scale below. To the left of the frequency scales, but also within the cut-out area, is a signal meter which acts as a center-of-channel indicator when turning to FM frequencies and as a signal-strength reading meter when AM stations are tuned to.

The upper section of the panel has a series of light in-

dicators to the left, which tell the program source selected as well as the reception of a stereo FM signal. To the right of these are a pair of output meters which read peak power delivered by the amplifier sections of the receiver. These have calibration notations at 0.1, 1.0, 10, and 100.0 watts, referenced to 8-ohm loads, and therefore provide a fairly accurate indication of power being fed to the speakers over a little more than 30-dB range.

The lower section of the panel contains all of the operating controls, with the exception of the tuning knob which straddles part of the dial opening and the upper section of the panel at the right. Rotary controls include a program selector switch (there are two aux positions, but only one pair of phono inputs), dual-concentric bass and treble controls, a channel balance control and, at the extreme lower right, a master volume control. Located between the balance and volume controls are eight pushbutton switches and a pair of three-position lever switches. The latter combine to offer two tape monitor circuits and dubbing from either of two connected decks to the other. The upper row of four push-buttons includes an MPX filter switch, FM muting switch, mono stereo switch, and a loudness control switch. The row of buttons below include a -20 dB volume attenuator, speaker-A and speaker-B selectors (either or both can be selected at once), and the power on/off switch. The headphone jack is located at the lower right of the panel, near the master volume control.

The rear panel of the STA-2000 contains a pair of a.c. convenience receptacles (one switched, one unswitched), a line fuseholder at the left, screw-type terminals for speaker wire connections, and two pairs of phono-tip jacks which parallel the regular speaker terminals. We know of no high fidelity speaker system which comes equipped with fixed cords terminated in phono tip plugs and, although the duplication of speaker terminals in this form costs Radio Shack just a few pennies, these jacks could lead users to presume that *both* kinds of speaker terminals can be used simultaneously. The owner's manual rightly cautions against this practice, of course, but not every eager audiophile reads the manual.

Wire jumpers are installed between the preamp-out and main-amp in jacks, permitting separation of these two sections of the receiver for independent use. DIN sockets are supplied for the Tape 1 and Tape 2 circuits, as are conventional phono tip in and out jacks alongside. The usual phono and high level input jacks come next, along with a ground terminal.

Vertically arranged screw terminals accept 300-ohm, 75-ohm, and AM external antenna connections, and a pivotable ferrite bar AM antenna can be swung away from the metal chassis for AM reception. The line cord of the STA-2000 is equipped with a capacitive clamp which comes connected to one of the 300-ohm FM antenna terminals and is intended to serve as an "indoor FM antenna." Users of this receiver should disconnect this "substitute antenna" and connect either an outdoor FM antenna or a properly oriented indoor di-pole antenna to avoid the multipath problems commonly encountered when using "the entire house wiring" as an antenna.

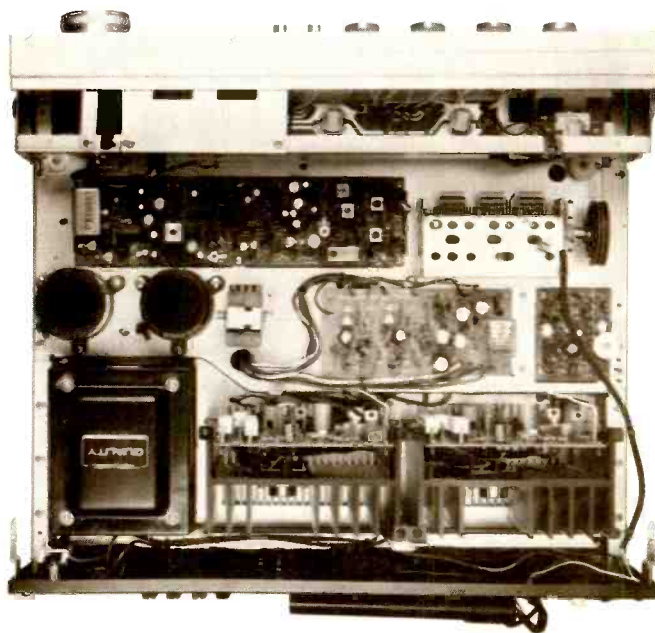

Internal Construction and Circuit Layout

Individual circuit modules in the STA-2000 include a separate front end, equipped with a MOS-FET r.f. amplifier stage, four-gang tuning capacitor (three-gang for AM), and a tuned r.f. stage in the AM section which is external to the front end and located on the main tuner i.f. and MPX section. The FM i.f. section employs a quadrature limiter-detector IC as well as a phase linear, ceramic filter interstage tuning arrangement. Two bi-polar transistor stages precede the multi-purpose IC. An IC multiplex decoder employing the phase-lock loop principle is used for stereo decoding. Both phono preamp circuits are contained on their own circuit module and employ a differential amplifier pair at the input plus two more transistors per channel in a conventional feedback equalization circuit. The next board is the tone control and voltage amp section, and tone controls are of the familiar negative-feedback Baxandall design. Two identical power amp modules employ a differential amplifier input stage and are direct coupled from input to speaker outputs. A separate module contains a five-transistor plus relay protection circuit. Three forms of circuit protection insure against overdrive, thermal, and speaker problems, including "dead shorting" of speakers. Other circuit modules within the STA-2000 include a power meter circuit board, the pow-

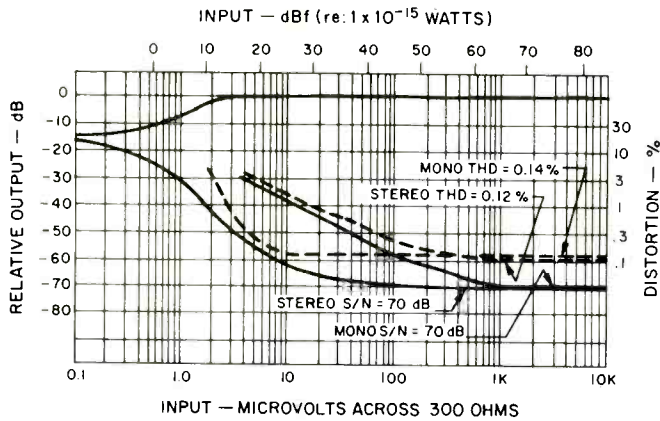

Fig. 1 — FM quieting and distortion characteristics.

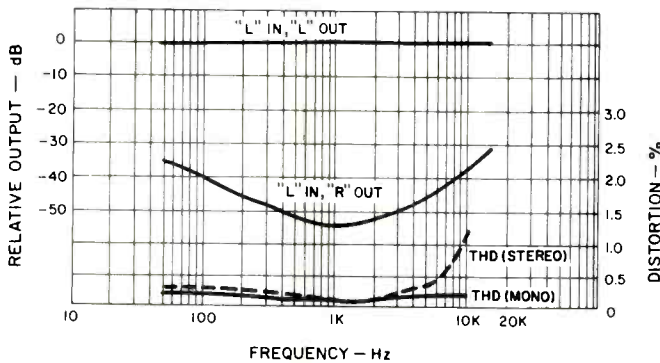

Fig. 2 — Separation and distortion vs. frequency.

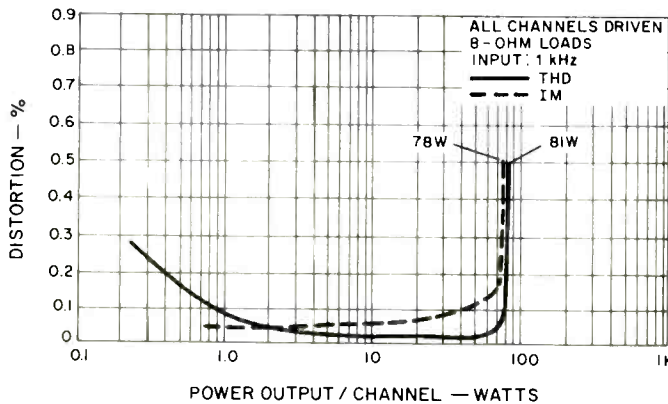

Fig. 3 — Harmonic and intermodulation distortion characteristics.

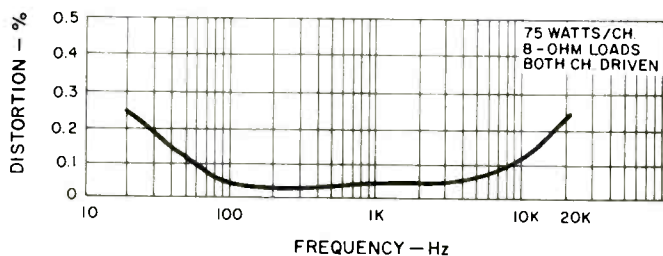

Fig. 4 — Distortion vs. frequency, both channels driven with 75 watt, 8 ohm loads.

er supply circuitry board, the muting circuit board, and a small board which takes care of the tape monitor and dubbing switching connections.

Tuner Section Lab Measurements

Some of the more important performance characteristics of the FM section of the STA-2000 are graphed in Fig. 1. Usable sensitivity in mono was $2.2 \mu\text{V}$ (12.0 dBf), while in stereo, the usable sensitivity point was reached with a signal input of only $5.0 \mu\text{V}$ (19.2 dBf). Switching to stereo takes place at $3.2 \mu\text{V}$ (15.3 dBf). Just $2.7 \mu\text{V}$ (13.8 dBf) were required to provide 50 dB of quieting in mono, while in stereo, it took $40 \mu\text{V}$ (37.2 dBf) to reach this quieting level. Ultimate S/N in both mono and stereo reached 70 dB at strong (65 dBf) signal levels. Distortion in stereo actually measured a shade better than in mono (0.12 per cent as against 0.14 per cent at 1 kHz), a condition which suggests that some form of distortion cancellation was taking place between the two circuit sections involved. In any event, both figures were far better than claimed by the manufacturer. Capture ratio measured 1.5 dB, as claimed. Spurious rejection measured better than 90 dB, while image and i.f. rejection were both better than claimed, measuring 85 and 82 dB respectively. AM suppression was exactly as claimed, at 55 dB.

Stereo separation at mid-frequencies was an incredibly high 54 dB, tapering off to 36 dB at 50 Hz and 38 dB at 10 kHz. Figure 2 shows the separation characteristics as a function of test modulating frequencies. Also shown are the distortion curves versus frequency for both the mono and stereo reception modes.

As for the AM tuner section, we measured a very acceptable sensitivity of $12 \mu\text{V}$ using the external antenna connection, and distortion, for strong signals, was 1.0 per cent as against 1.2 per cent claimed, at 30 per cent modulation. I.F. rejection measured 58 dB, while image rejection was exactly 60 dB as claimed. Signal-to-noise was an acceptable 47 dB.

Amplifier Section Measurements

While the amplifier section delivered 81.0 watts per channel into 8-ohm loads with a central test frequency of 1000 Hz, at the frequency extremes of 20 Hz and 20 kHz, the amplifier delivered precisely the claimed 75 watts per channel. IM distortion was 0.16 per cent at 75 watts output, while at this rated output level, THD was a low 0.056 per cent. THD and IM distortion are plotted for power levels from below 1 watt to above rated output in Fig. 3. Harmonic distortion as a function of audio frequency is plotted in Fig. 4 for a constant output of 75 watts per channel.

Frequency response from the high level inputs was flat within 1 dB from 12 Hz to 41 kHz and within 3 dB from 9 Hz to 55 kHz. Input sensitivities were virtually identical to those claimed for both phono and high level inputs. Phono overload occurred at an input level of 220 mV, close enough to the 230 mV claimed and certainly high enough so as not to present any problems when the receiver is used even with high output magnetic cartridges playing dynamically recorded discs. Unweighted phono signal-to-noise ratio was 69 dB, referenced to actual input sensitivity. Hum and noise through the high level inputs measured 87 dB below rated output, much better than the 75 dB claimed. At minimum volume settings, hum and noise measured 90 dB below full output.

Tone control characteristics are displayed in the scope photo of Fig. 5 and correspond almost exactly to published claims of range at 100 Hz and 10 kHz. Shown in Fig. 6 are several plots of response taken with the loudness control switch on, each plot some 10 dB lower than the preceding one, in terms of volume control settings. Note that this receiver

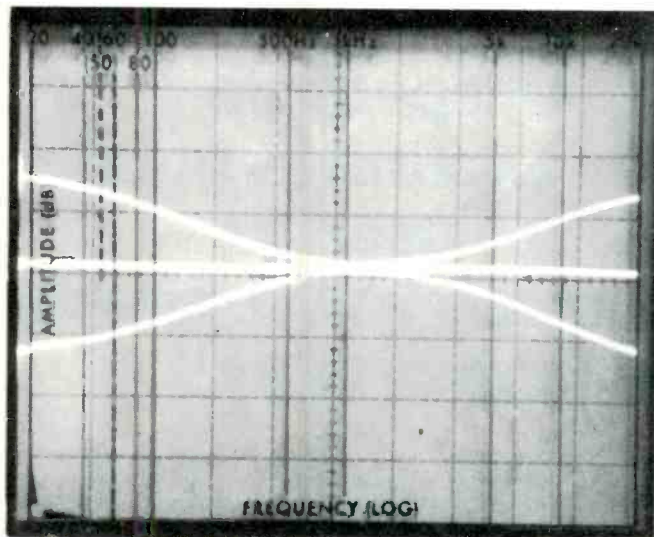

Fig. 5—Tone control range of Realistic STA-2000.

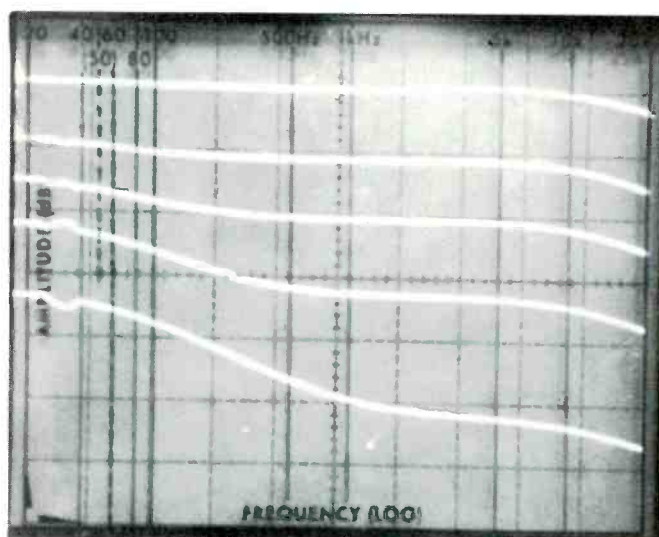

Fig. 6—Loudness control action.

boosts only the "lows" when the loudness control circuit is activated. The argument as to whether both lows and highs need to be emphasized for loudness compensation has been going on for years, and we tend to agree with Radio Shack's approach.

Listening and Use Tests

Radio-Shack's receiver line has obviously come of age. All the features one looks for in a high-quality integrated receiver are there, with the possible exception of low-cut and high-cut filters. Power is clean and ample, even when the unit is driving lower efficiency speaker systems. At this price and power level, some prospective purchasers might have preferred dual phono inputs instead of the twin high level inputs, but those seeking excellent basic circuit design,

good external design, and reliable long-term performance will still find it in Radio Shack's Realistic STA-2000 receiver. The only thing which seems to have been lost in the process of upgrading is the *tremendous* price advantage that earlier Realistic products offered. Just about all of the other "just under \$500" receivers around offer just a couple of watts less power, a few offer the same power and one or two offer even more power for this price than does the STA-2000. Having moved right up into the "big league," the Realistic STA-2000 must therefore be judged on the basis of its control features and its audible performance rather than solely on the basis of watts per dollar. Judged in this way, the STA-2000 is likely to capture its rightful and significant portion of the ever-growing integrated receiver market.

Leonard Feldman

Check No. 90 on Reader Service Card

66

Sony TAE-5450 Preamplifier



MANUFACTURER'S SPECIFICATIONS

Frequency Response: 10 Hz to 100 kHz, +0, -1 dB.

Residual Noise: Less than 200 μ V, volume control at minimum.

Sensitivity: Phono, 1.5 mV; high level, 150 mV.

Signal-to-Noise Ratio: Phono, 70 dB; high level, 90 dB.

Rated Output: 1 volt; maximum, 14 volts.

Dimensions: 18 1/4 in. (46.36 cm) W by 12 3/4 in. (32.39 cm) D by 6 3/4 in. (17.15 cm) H.

Weight: 29 1/2 lbs. (13.41 kg).

Price: \$450.00.

Sony's TAE-5450 preamplifier could, I suppose, be considered an economy version of their \$1300 top-of-the-line TAE-8450. And while it is true that the "little brother" has no meters, microphone inputs, or some of the other refinements, in terms of basic performance parameters, such as frequency response, low distortion, and signal-to-noise ratio, the TAE-5450 is very similar to the all-out version. But, most im-

portantly, it is only about a third the price of its big brother—which makes it a bargain by any standard.

Styling is fairly conventional, with the brushed stain front panel angled back for an inch or so, to meet the black top plate, and the two wooden side pieces finished in walnut veneer. The *On/Off* switch, which incidentally has an illuminated indicator in its center, is on the left-top, while just

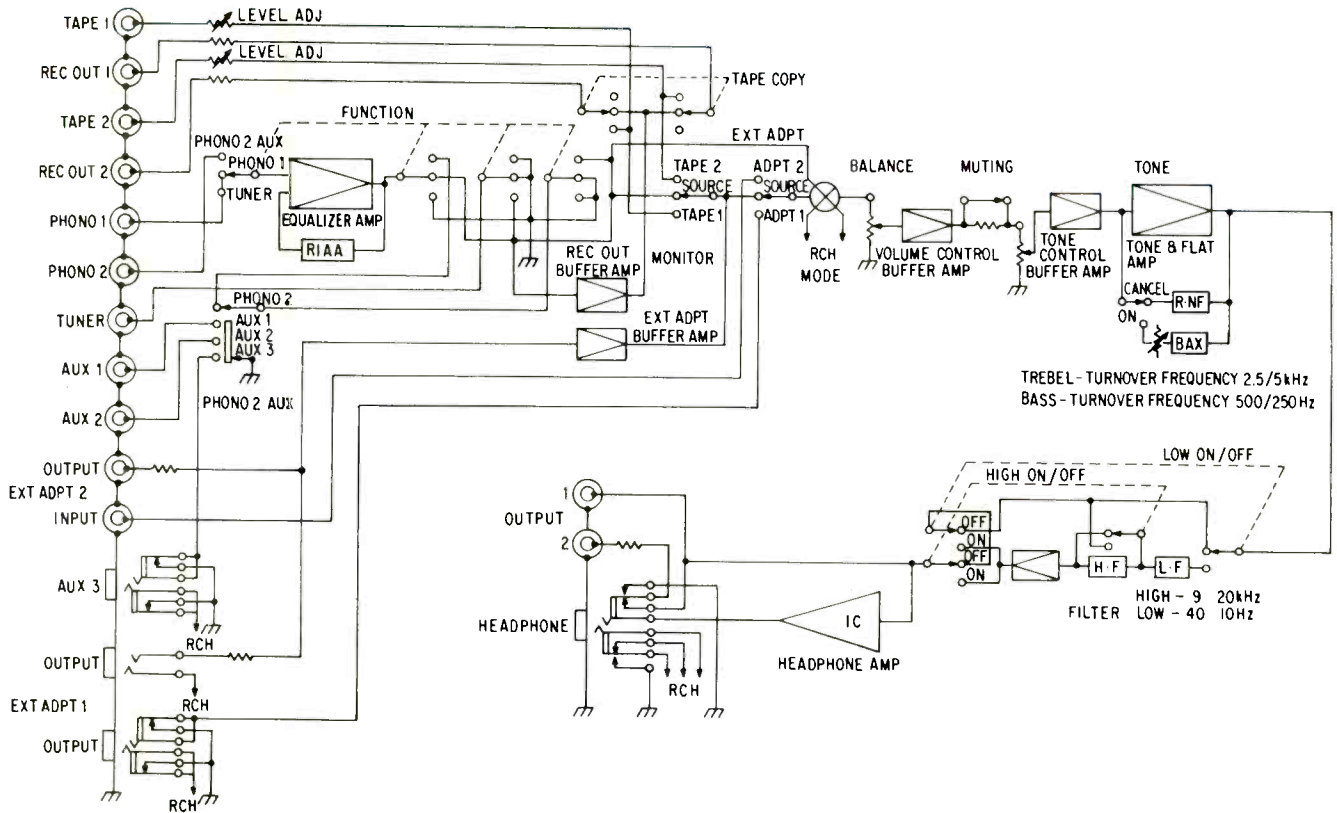

Fig. 1—Block diagram of the Sony TAE-5450. Note the separate headphone amplifier.

beneath and to the right is a set of four tone controls—two for each channel. To the right of the tone controls comes a three-position external adapter switch associated with two phone jacks just beneath. A tape copy switch is next in line towards the right, followed by the secondary function selector switch for *Phono 2* and the *AUX* inputs (more about this system later). The final switch in this line is the mono/stereo mode switch with the usual five positions, *Stereo*, *Reverse*, *Left*, *Right*, and *Left Plus Right*. Just beneath this last control is the balance switch, while just above it is the large master volume control and associated lever-type muting switch. Two more lever-type switches are just to the left of the muting switch, the primary function selector switch and the tape monitor switch.

Along the bottom, going from left to right, are the headphone jack, low filter turnover button, low filter on/off button, high filter turnover button, high filter on/off button, bass tone control turnover button, treble tone control turnover button, and tone control defeat button. These seven button switches are push-push types.

Sony has had an interesting and somewhat unique approach to the human engineering of the function selection system of their preamps and amps for some years now, and

the TAE-5450 continues that type of system. The primary function switch is a three-position, lever type, with *Tuner* as the bottom position and *Phono 1* as the center, while the upper position, labeled *Phono 2/AUX*, engages whatever has been selected through the secondary function switch. This secondary selector, a four-position rotary switch, handles the *Phono 2*, *AUX 1*, *AUX 2*, and *AUX 3* inputs, the last of which is coupled via the phone jack just beneath. Thus, Sony provides selection of the three basic signal sources through the primary lever selector, which will probably cover better than 90 per cent of a user's needs, yet three additional sources can be chosen just by a twist of the secondary knob. A good idea of how the system works can be had from the block diagram, Fig. 1.

On the rear of the unit are some 26 RCA phono jacks for the inputs and outputs, as well as two switched a.c. outlets, one unswitched outlet, and a thumbscrew ground connection. Note, too, that each of the tape recorder inputs has its own level control.

Technical Measurements

The first tests were for output level versus distortion, and the results are shown in Fig. 2. Maximum output voltage was

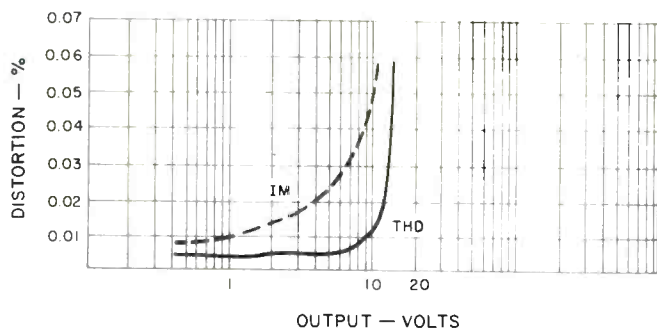

Fig. 2—Output versus distortion.

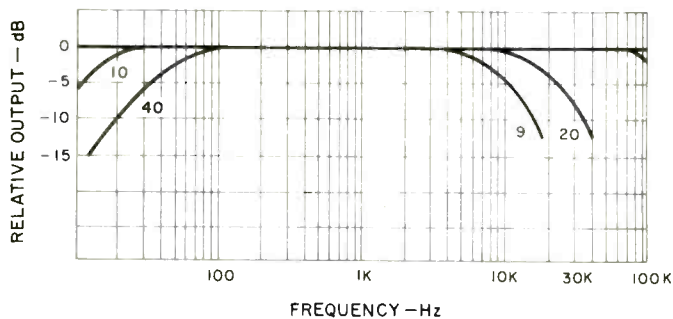
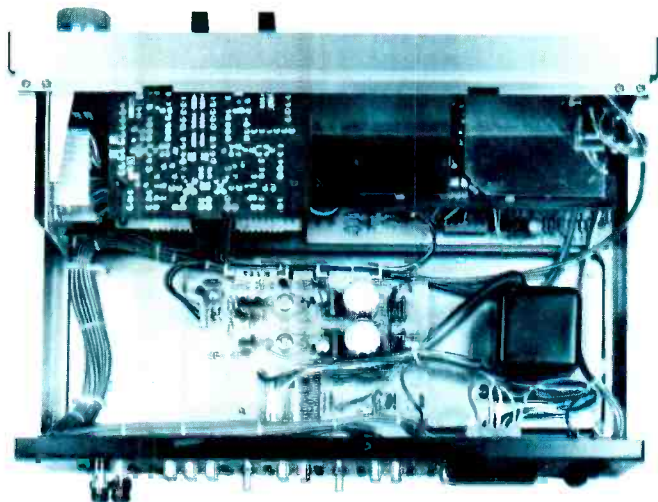

Fig. 3—Frequency response and filter characteristics.



70



11.5 volts at low impedance, which is much higher than would be needed since most power amplifiers require inputs of only 1 to 2 volts for maximum output. Total harmonic distortion for three volts output was less than 0.005 per cent, increasing to 0.01 per cent at 8 volts output. IM distortion was less than 0.03 per cent at 6 volts output, while for 2 volts output it was 0.015 per cent. With the high frequency filters switched in, maximum output fell to 6.5 volts. While harmonic distortion didn't begin to increase until about 7 volts output, IM distortion had doubled by the 4 volt output level, though it was still quite reasonably low and well within the specified 0.05 per cent.

Switching in the tone controls had no measurable effect on distortion, although a very slight rounding of a 20-kHz square wave could be detected. Figure 3 shows the frequency response and the effects of the filters; note that the upper -3 dB point is well above 100 kHz, but that the 20-kHz filter can reduce the response accordingly—so both the wide and narrow bandwidth schools of design should be satisfied! Note also that the low frequency filters do not begin to at-

tenuate from 100 Hz or below, unlike the case with the simple circuits almost invariably used on less elaborate amps and receivers. The tone control characteristics can be seen in Fig. 4, where the solid lines indicate the maximum and minimum response obtainable with the turnover points at 500 Hz and 2.5 kHz, while the dashed lines indicate the response obtainable with the 250 Hz and 5 kHz "hinges."

The input signal level for 1 volt output was exactly 150 mV for the high level inputs, and the signal-to-noise ratio there was 90 dB. Phono sensitivity was 1.2 mV, and the signal-to-noise ratio was more than 2 dB better than claimed at 72.5 dB (inputs shorted, "A" weighted). The maximum signal handling capacity for the phono input before visual distortion of a wave form on the 'scope was 120 mV. Crosstalk measured 58 dB at 1 kHz and 37 dB at 10 kHz.

Listening and Use Tests

For the listening and use tests, the Sony TAE-5450 was teamed up with a Phase Linear 400 power amp, a Dynaco AF-6 AM/FM tuner, and a Harman/Kardon (Rabco) ST-7 turntable fitted with a Goldring G900 SE phono cartridge. Loudspeakers used were Infinity's Quantum Line Source One or a dynamic/electrostatic hybrid design by the reviewer. A TEAC A-2300 and an AIWA AD-1800 cassette deck were also pressed into service for some tape dubbing. Program material included the usual variety of items, plus two new direct-to-disc recordings, **Direct Disco** (CCS 5002), a 45-rpm disc from Crystal Clear Records in San Francisco, and **Rough Trade—Live** (UMB DD1) on the Canadian Umbrella label. (Editor's Note: This last disc is extremely well done and should not be missed by fanciers of top-quality discs, no matter what their taste in music. It is available through Audio-technica phono cartridge dealers in this country.)

Fig. 4—Tone control characteristics.

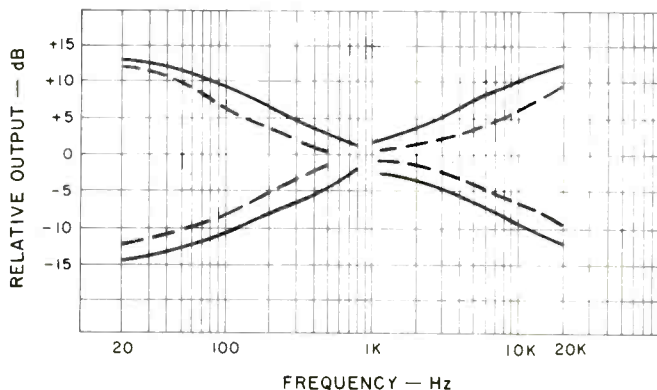

As far as I could tell during my extended listening test, Sony's TAE-5450 preamp did not affect the sound quality in any way. Signal to noise was excellent, and the tone controls and filters helped a great deal in shaping signal sources which were "off." While the controls did take a while to get used to, principally because of their great variety, I must say that this TAE-5450 is one of the most versatile preamps I have

yet tested—particularly with respect to the tape recording facilities and the large number of auxiliary inputs and outputs. Many enthusiasts will find the front panel jacks very convenient—they certainly save a lot of trouble.

As I mentioned earlier, I initially thought the unit was a bargain at \$450.00. After testing it for several weeks, I am still of the same opinion.

George W. Tillett

Check No. 91 on Reader Service Card

Marantz Model 510M Basic Amplifier



72

MANUFACTURER'S SPECIFICATIONS

Power Output: 256 continuous average watts per channel, both channels driven into 8 ohms from 20 Hz to 20 kHz with 0.05 per cent total harmonic distortion; 350 average watts per channel, with similar conditions except 4-ohm loads with 0.10 per cent total harmonic distortion, and 140 average watts per channel with similar conditions except 16-ohm loads with 0.10 per cent total harmonic distortion.

Intermodulation Distortion: Less than 0.1 per cent at or below rated power using SMPTE method.

One-Watt Frequency Response: -3 dB at 2 Hz and 120 kHz.

Input Sensitivity: 2.26 V rms for 256 watts into 8 ohms.

Input Impedance: 25 kilohms, not affected by gain control setting.

Slew Rate: ± 15 V/ μ S.

Hum and Noise: -110 dB below rated output, 8 ohms.

Damping Factor: Greater than 100 at 1 kHz, 8-ohm load.

Phase Shift: Leading 9 degrees at 20 Hz, lagging 10 degrees at 20 kHz.

Dimensions: 15-3/8 in. (39.04 cm) W by 6-1/8 in. (15.55 cm) H by 14 in. (35.56 cm) D.

Weight: 46 lbs. (20.7 kg).

Price: \$999.95; Model 510, less meters, \$899.95.

The Model 510 is one of Marantz's newest amplifiers in the medium to high power range, continuing their 500 series, and its styling is typical of recent products from this company. The front panel of the basic model contains two level controls, a power switch, and peak indicators; included in the "M" version we tested are two large, illuminated meters and a meter range switch.

The unit is well made and very compact, with a large encapsulated power transformer, two filter capacitors, and the cooling tunnel occupying the majority of the chassis interior. Inside the tunnel are 16 output transistors, each having a small staggered-fin radiator, across which cooling air is drawn from a temperature-controlled two-speed fan. Mounted on either side of the tunnel are the amplifier boards, which allows the transistor pins to solder directly to

the printed conductors, thereby saving both space and considerable chassis wiring. The top cover is perforated and has a foam air filter mounted to its underside to keep dust and other debris from being drawn into the box. Marantz recommends periodic cleaning; this is easily accomplished by vacuuming the top surface of the amplifier.

Mounting and installation of the unit is straightforward, with details in the owner's manual. Several inches should be allowed atop the amplifier installation for it to draw cool air, and an opening is similarly required behind the fan for warm air exhaust. All connections are made to the rear panel. Speaker jacks are the five-way binding post type, and inputs are 1/4-in. phone plugs. Provided with the amplifier are adaptors to convert the inputs to the more common RCA jacks.



One fuse on the rear panel interrupts the a.c. line in case of amplifier failure, while external, in-line fuse holders are provided for speaker protection. In the owner's manual are diagrams showing the proper connections and guidelines for fuse selection. The use of these fuses is recommended.

The meters are calibrated to show full scale at +3 dB with sine wave inputs at 256 watts/channel, 8 ohms, and the meter switch in the +20 dB position. Also provided on the meter range switch are: Off, +10 dB, and 0 dB positions, with the latter two changing the full scale readings to 25.6 watts and 2.56 watts respectively. Internal calibration was provided for each meter, and their adjustment was found to be quite accurate after the amplifier warmed up for a few minutes. Worst case error proved to be about 1 dB which should be quite adequate for checking average power levels using musical program materials.

Short duration peaks are captured and held by front panel lamps and their associated circuitry. These were set to trigger at about 63 volt peaks (250 watts/channel at 8 ohms) or if the positive half cycle limiter is engaged. Peak-hold displays are certainly useful, though 510 users would be unnecessarily conservative if they were to always play music "soft" enough to entirely avoid lighting these peak indicators because the 510 doesn't clip or limit before pumping a healthy 347 watts into an 8-ohm load or 536 into 4 ohms, driving both channels at 1 kHz.

(Editor's Note: Marantz tells us their design intent on the peak load indication system was to indicate the *approach* of clipping on peak transients, rather than an actual clipping situation. Thus, the system should not be considered as indicating an overdrive situation, as the LEDs will light up before actual clipping. The system tracks the power supply voltage so it will always give the same warning margin that clipping is approaching, regardless of the a.c. power line variations. While the circuit turns on in microseconds, the "hold" portion of the circuit keeps the LEDs lit long enough so they can be seen by the eye. The system indicates an actual overload condition by staying on more or less continually. Thus, 510 users should consider occasional flashing of the LEDs as full use of the normal operating range.) On the amp submitted for review, a 3 dB difference was found in channel balance when both controls were set at 50 per cent mechanical rotation. When using these controls at less than maximum gain, it is recommended that the settings be made by the amp's meters or verified with oscillator and voltmeter if you wish precision in balancing.

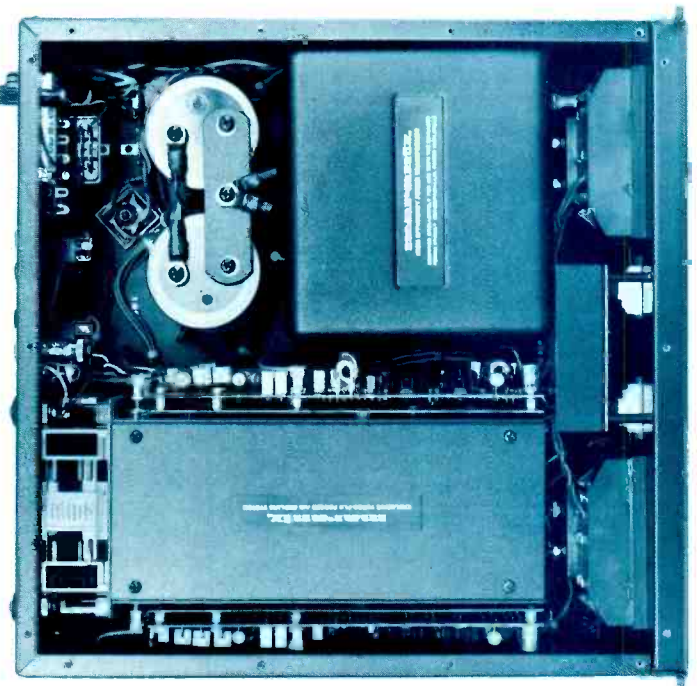

Circuit Description

Suitably attenuated input signals are a.c. coupled to the unity gain buffer amplifier, which uses Q301 and Q302 in a circuit often called an amplifier emitter follower. This stage exhibits a high input impedance which minimizes the loading on the gain control and the preamplifier. Minimum input impedance for the 510 is approximately 31 kilohms, so preamp manufacturers' specifications should be checked to ensure compatibility, especially if vacuum tube preamp models are used.

Capacitor C307 couples the buffer amplifier to the non-inverting input of the differential amplifier Q304 and Q306, and feedback is applied as usual to the inverting input. Marantz has used an uncommon but simple circuit to combine both phases of output signal from the input stage, while also getting the ability to pull the driver stage hard in either the positive or negative direction. Transistor Q307 is the key to this circuit; it is connected as a common emitter amplifier to get the necessary signal inversion and voltage translocation, but degenerated to a gain slightly less than 1,

Decca Record Brush:

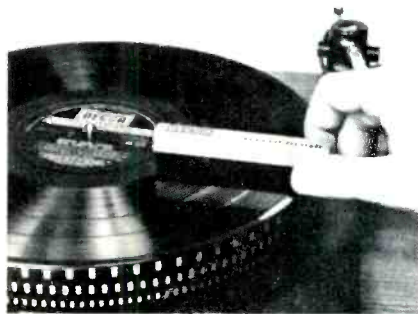

No Side Effects

Most record cleaners use liquids. They do the job. But not without side effects which reduce the life of your records.

To see why, imagine you are examining a record groove through a microscope while various liquid cleaners are tried. All the cleaners remove a lot of dust, but even the best ones leave some behind. Since liquid was applied, this soft dust dries into hard grit. While the stylus could have pushed a few soft dust particles out of its way, it must now track hard grit particles like they are part of your record. The result: distortion. Not to mention stylus wear caused by the new bumps and grinds it must now traverse.

Decca's research into these liquid side effects, resulted in their pioneering of a new, electrically conductive, carbon micro-fiber - the bristles of the Decca Record Brush. Each Decca Record Brush contains one million of these ultra-thin conductive bristles - 1000 enter each groove removing dust, dirt - and draining off static for lower surface noise and expanded dynamic range.

Decca Record Brush. No fluids, no side effects. Just keeps your records sounding like the first time.

Decca Record Brush available at quality dealers across the U.S.

Sugg. list \$14.95

ROCELCO INC.

160 Ronald Dr.,
Montreal, Canada H4X 1M8
Phone (514) 489-6841

Check No. 31 on Reader Service Card

Fig. 1—Schematic diagram of the Marantz 510M.

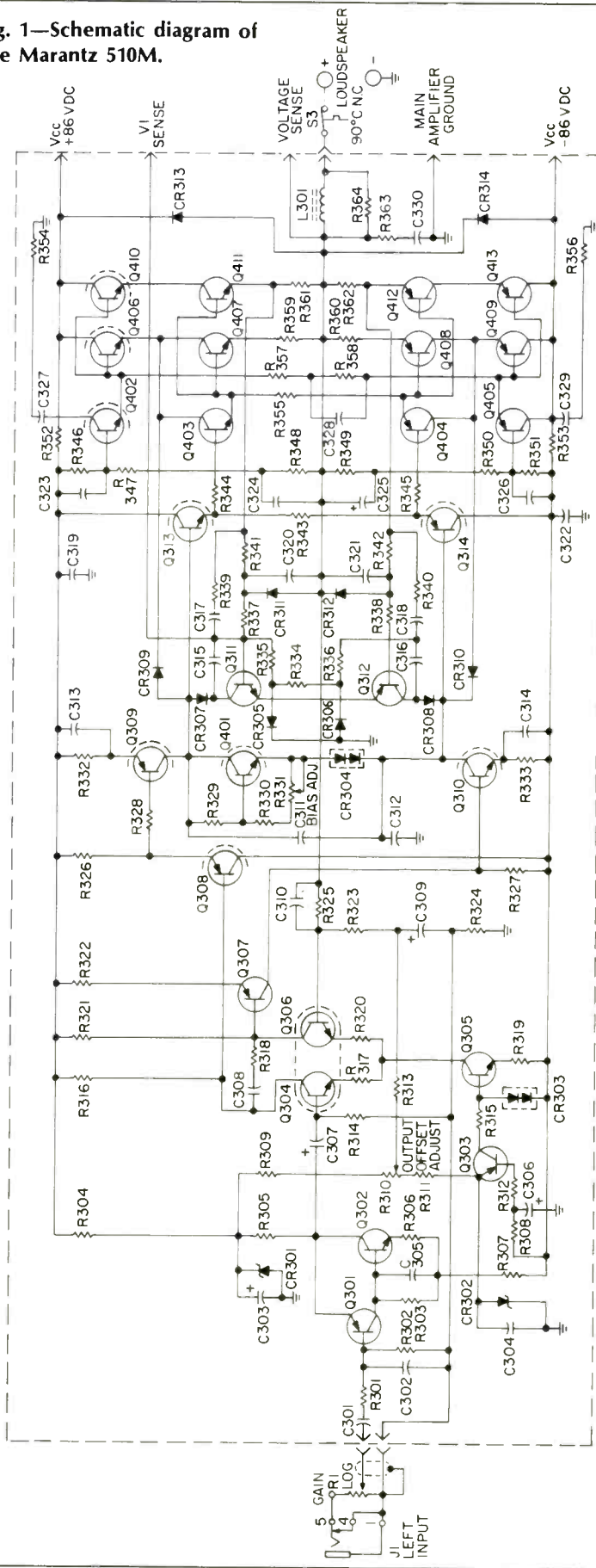

in order to match its characteristics to its mate, Q308, connected as an emitter follower. It can be shown that the driving signal at the collectors of Q309 and Q310 will be relatively free of even harmonics by nature, if the transistors are chosen carefully and the resistors involved are properly balanced.

The output stage and its drivers are straightforward, being similar in design to those of other high quality amplifiers currently in production. Eight output transistors are used per channel in a complimentary, series-parallel arrangement. Such a design allows the use of low voltage epitaxial base devices, giving the composite stage a very good safe operating area (especially important with reactive loads such as electrostatic speakers) and good current linearity as well.

V-I limiting is employed for protection, but its action is not instantaneous, so short duration transients will not trigger unnecessary limiting. Capacitors C315 and C316 are used to accomplish this effect. Figure 2 shows the amplifier forced into limiting with 2-ohm, 2- μ F series R-C network, in parallel with 8 ohms and the amplifier output. Note that limiting action is symmetrical and without spurious glitches or oscillation.

Measurements

The 510 was first asked to deliver one-third rated power into four ohms, both channels driven with a 1 kHz sine wave, for an hour, as per FTC requirements. Being close to the maximum internal power dissipation point, the exhaust air quickly heated up and the high speed switch for the fan turned on in less than 30 seconds. The amplifier ran continuously for about 15 minutes, and then the two thermal switches, set to 90° C., opened and closed alternately for the remainder of the test. It took about seven cycles of thermal cut-out and 1 hour, 20 minutes to accumulate a total of one hour running time.

After a very brief cooling-down period, the amplifier was then connected to a suitably large set of 4-ohm non-inductive load resistors and a Sound Technology 1700A THD analyzer. The right channel of the amplifier showed more distortion at high frequencies than the left, reaching 0.10 per cent THD at full power into 4 ohms, while the left channel remained at or below 0.03 per cent up to 20 kHz. Figure 3 shows THD for both channels as a function of frequency. This rise in distortion with increasing frequency reflects the drop in amplifier open-loop gain, thereby reducing the negative feedback available to correct the amplifier's internal non-linearities, and these effects are common to the large majority of tube and transistor power amplifiers. Figure 4 shows a sample of the nulled THD residual and the amplifier output at 10 kHz and 100 watts into an 8-ohm load.

An attempt to measure IM distortion with respect to power output was made using a Crown IMA. Starting at 256 watts per channel into 8-ohm loads, the figures measured with 0.006 and 0.001 per cent for the left and right channels respectively. As power was decreased in 10-dB steps, both channels fell rapidly into the noise, with no measurable increase in IM products on the way down. No figures are presented for the sum of 5th and 7th harmonics as this amp was unmeasurable with this test and the available equipment, i.e. measurements were at the residual of the test equipment, 0.001 per cent, at or below rated power, both channels driven into 8-ohm loads.

Frequency response, as shown in Fig. 6, is a plot of the measured values with the gain control full up and the signal generator set for an amplifier output of 1 watt at 1 kHz with

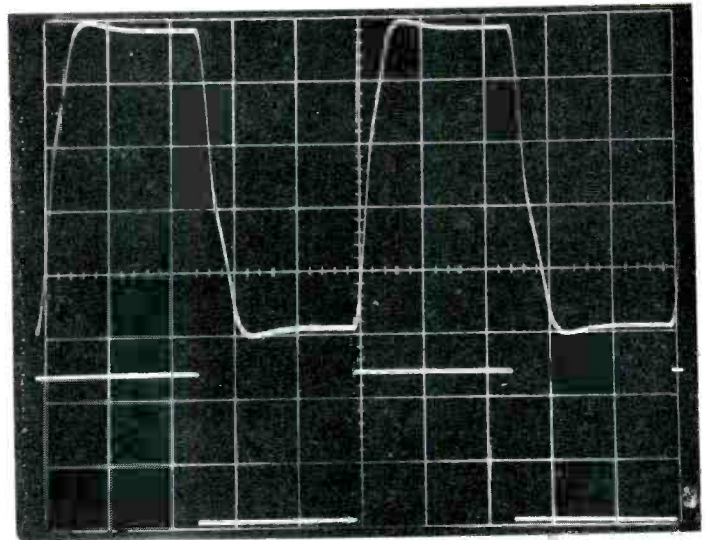

Fig. 2—Top, amplifier forced into limiting with a load composed of 8 ohms paralleled with a series R-C network of 2 ohms and 2 μ F. (Traces: top, 20 V/div. & 20 μ S/div.; bottom, 2 V/div. & 20 μ S/div.)

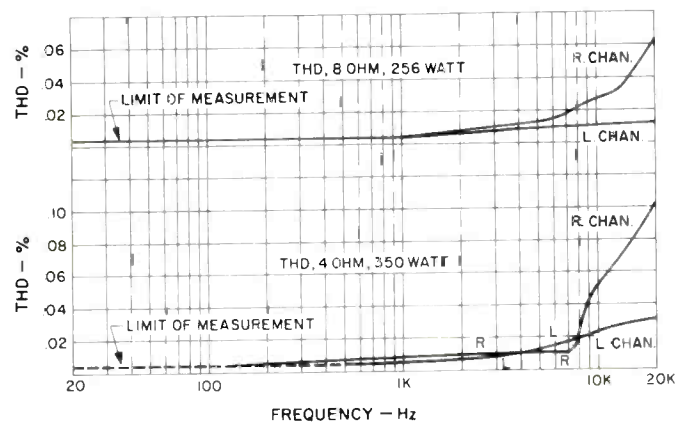
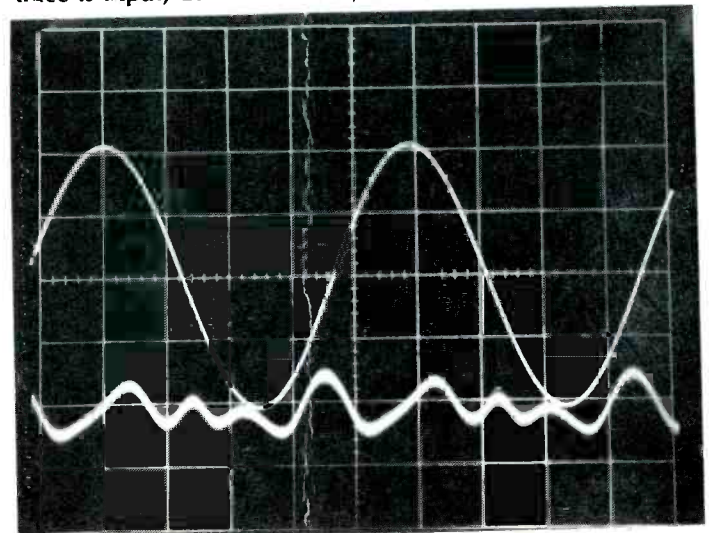

Fig. 3—Frequency vs. THD at full power into 4- and 8-ohm loads.

Fig. 4—Nulled THD residual of 10 kHz, 100 watts into an 8-ohm load; residual is 0.012 per cent. Upper trace is input; 20 V/div. & 20 μ S/div.



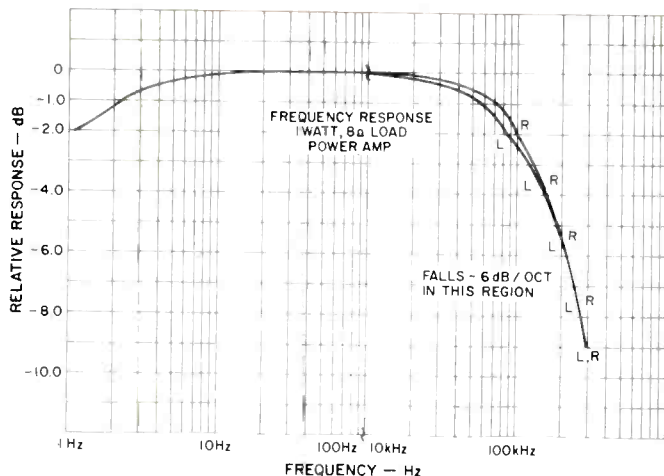

Fig. 5—One-watt frequency response; note break in frequency scale at 100 Hz/10 kHz.

an 8-ohm load. Measurements above 100 kHz are presented for comparison purposes only, since this range will show considerable variation with changes in load, power output, and gain control setting.

Damping factor is exceptionally high with the 510, over 500 for any frequency below 300 Hz, though falling rapidly at frequencies over 500 Hz. The fall in damping factor in this range is, again, typical of transistor power amplifiers. Decreasing feedback and the series output inductor both contribute to increasing output impedance at higher frequencies. Even at 10 kHz, however, the damping is still greater than 50. The curve shown for damping factor is that of the left channel. The right channel hit 626 at 20 Hz and followed the left's slope with increasing frequency. Although these numbers can be measured in the laboratory, this reviewer doubts they can be directly related to the sonic qualities of amplifiers. With figures this large, damping factor in the system will probably be totally dominated by speaker and wiring losses. Such measurements are of inter-

est, however, in that they provide one more small piece of data on the nature of the electronics for those interested in detailed comparisons of high level audio equipment.

Maximum gain was well matched between the two channels and averaged 26.2 dB; Marantz specified 26.03 dB. This means the preamplifier will be asked for some 2.6 volts rms to drive the amplifier into clipping—easily with the capabilities of current high quality preamp designs.

Figure 6 shows square wave performance with reactive loads, this one being a 2-ohm, 2- μ F series R-C network. Note the well-damped and symmetrical transitions. Table I shows output noise vs. volume control rotation for two bandwidths. Even the worst case figures reflect excellent performance and should be inaudible under all conditions, even with efficient speakers.

Table I—Output noise vs. volume control rotation for two bandwidths; all measurements in μ V.

Control Position	20—20 kHz		400—20 kHz	
	Left	Right	Left	Right
Off	41.8	75.4	17.6	23.7
20%	42.9	77	19.6	24.8
40%	49.6	74.3	23.1	28.1
60%	53.9	67.1	33.0	40.7
80%	54.0	107	37.4	44.0
100%	38.5	114	17.6	33.0

Listening Tests

While it's conceivable that some users of this amplifier would be bothered by the continuously running cooling fan, the noise level of the 510's fan appears to be lower than most other fans used presently in high power amplifiers. What sound it does produce will be swamped by moderate levels of music and should not be audible for more than a few feet if no music is playing.

After the initial set-up, we sat down to serious listening, which was performed before the technical measurements. The 510 amplifier quickly proved itself in direct A-B comparisons with other high quality units which have been found, by many highly critical listeners and over a period of time, to not only be quite accurate but also very easy to enjoy. Over long stretches, the 510 was judged to be a fine sounding piece of audio gear, and this amplifier could definitely belt out the decibels better than any of those used for comparison. Also, and again much to its credit, there was no report from any listener of edginess or irritation. For some listeners, this amp did not take absolute first place, since in the last fraction of its power range the high end did not have the ultimate in "space" and "openness" and the midrange had a very slight tendency to become "hard" mostly with a strong male vocalist at the same power levels. (Editor's Note: The power levels described here will break down most speakers fairly quickly, if applied continuously, and are usually considered beyond the normal listening range.) Especially appreciated by all listeners was the solid and powerful bass reproduction at tremendous volume levels achieved with this amplifier.

In conclusion, those who require a very powerful amplifier with a first-class sonic rating must audition this unit. They can be assured that its performance and quality of construction are commensurate with its price. *George D. Pontis*

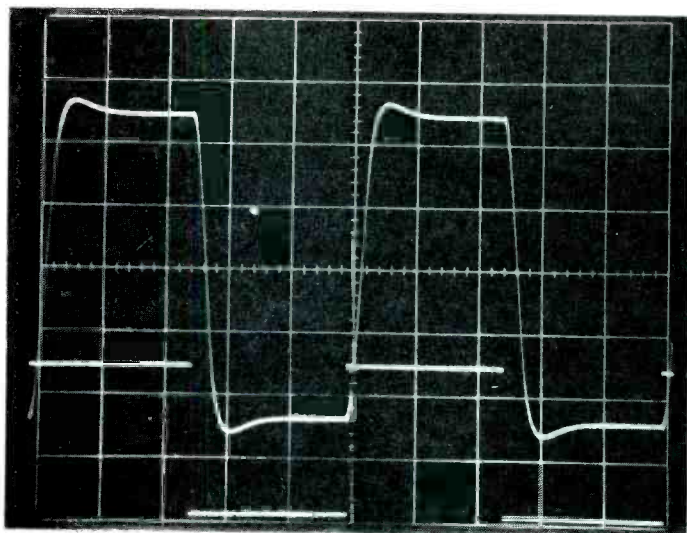

Fig. 6—Square-wave performance into a reactive load. Top: Amplifier output with 10-kHz square wave (20 V/div.) Bottom: Input 2 V/div. Timebase: 20 μ S/div.