



111 Powdermill Road, Maynard, Mass.

SERVICE BULLETIN
For
MODEL 299C STEREO AMPLIFIER

SPECIFICATIONS

Maximum power output each channel at 1000 cycles: Music waveforms...	40 watts
Steady state.....	35 watts
Maximum total harmonic distortion at rated output.....	0.5%
Frequency response for 35 watts steady state at less than 2.0% total distortion.....	20 to 20,000 cycles ±0 db.
Maximum usable power output at 20 cycles: Music waveforms...	42 watts
Steady state.....	36 watts
Power bandwidth at rated distortion (IHFM method).....	below 19 cycles to * above 25,000 cycles (limits of test equip)
Intermodulation Distortion.....	Below 0.5%
Signal for rated output -- NAB (NARTB) tape at 1 kc.....	3.0 mv.
Signal for rated output -- RIAA equalization at 1 kc.....	3.0 mv. (MAG 1&2 LOW)
Signal for rated output -- RIAA equalization at 1 kc.....	9.0 mv. (MAG 1&2 HIGH)
Signal for rated output -- Tuner, Extra, and Playback.....	0.50 volts
Hum and noise -- high level inputs.....	80 db. below rated pwr
Hum and noise - low level inputs.....	10 microvolts equivalent.
Scratch filter.....	Above 5 kc.
Treble boost and Treble cut (at 10 kc.).....	15 db. ± 2 db.
Bass boost and cut (at 50 cycles).....	15 db. ± 2 db.
Rumble Filter.....	Below 100 cycles

(These characteristics are measured at a line voltage of 117 volts rms and line frequency of 60 cycles per second. No significant changes of characteristics should be experienced for normal variations of line voltages or a line frequency of 50 cycles per second).

Input impedance -- low level inputs (MAG 1 & 2 LOW).....	47 k. ohms
Input impedance -- low level inputs (MAG 1 & 2 HIGH).....	150 k. ohms
Input impedance -- high level inputs.....	500 k. ohms
Minimum recommended load resistance on tape outputs.....	200 k. ohms
Maximum recommended cable capacitance on tape outputs.....	200 mmfds.
Range of line voltage and frequency.....	105-125 volts, 50-60 cycles.
Power consumption -- 17 volts at 60 cps (A.C. only).....	200 watts.

* All H. H. Scott amplifiers and preamplifiers incorporate a sharp cutoff filter (12 db. or sharper per octave) which becomes fully operative below 20 cycles. This is designed to prevent overload of the output stage and the loudspeaker due to subsonic rumble frequencies and record eccentricity. This means that the full power of the amplifier can be concentrated into the audible range.

GENERAL SERVICE NOTES

1. Check the tubes, particularly those in the power output stage and the rectifier every year. If the tubes are outside the manufacturer's ratings or show gas, they should be replaced. Gassy tubes may damage other components of the circuit.
2. When the amplifier is being checked yearly, clean the tubes of dust so that they may radiate their heat more effectively.
3. If at any time the hum or noise increases noticeably, check the power tubes. This symptom is often an indication of gassy tubes.
4. If the amplifier blows fuses frequently, check the line voltage. If it rises above 125 volts, drop the line voltage by means of an auto-transformer or place a voltage regulator transformer between the amplifier and the line. If the line voltage is correct, check the amplifier itself. Do not use fuse sizes other than the fuse size specified.
5. D.C. Balance Adjustment:

Equipment Needed - Oscilloscope and/or AC VTVM, 16 ohm resistive load of adequate wattage (some wirewound resistors have considerable residual inductance and these should be avoided).

The balance pot for each output stage is located between the output tubes for that stage. These controls should be adjusted when the output tubes age appreciably or are replaced. To set these controls use the following procedure:

- (a) Connect the 16 ohm resistor across the output terminal of the channel under test.
 - (b) Connect the oscilloscope and/or VTVM across the resistor, and turn the horizontal selector of the scope to "LINE".
 - (c) Remove the phase inverter tube 7199 of the output stage under test.
 - (d) Adjust the proper D.C. Balance Control for a minimum 120 cycle response on the scope or minimum reading on the AC VTVM.
 - (e) Repeat the entire procedure for the other amplifier output stage.
6. Tests can be performed to insure that the unit meets or exceeds the specifications outlined previously. Only use parts and tubes specified by H. H. Scott, Inc. The use of non-standard parts or tubes will preclude obtaining the performance stated in the specifications.

If you have any further questions, write to:

Technical Services Dept.
H. H. Scott, Inc.
111 Powder Mill Road
Maynard, Massachusetts

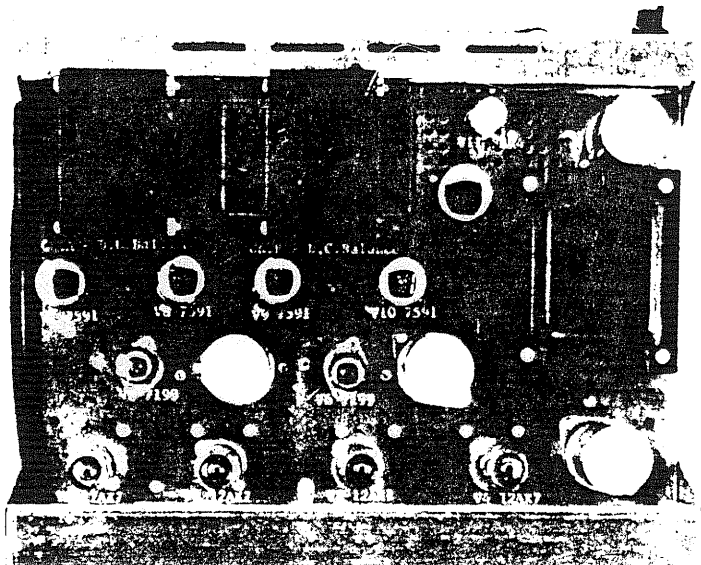

DECK 2 FRONT

STEREO SELECTOR SWITCH

POSITION	FUNCTION
1	BALANCE A
2	BALANCE B
3	MONAURAL RECORDS
4	STEREO
5	REVERSE STEREO
6	CHANNEL A
7	CHANNEL B

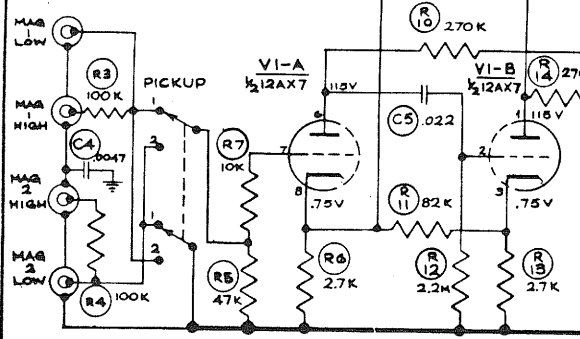
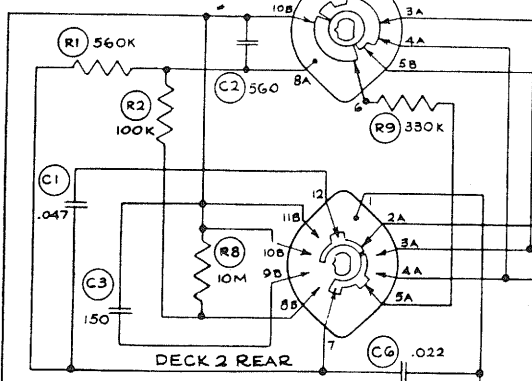

INPUT SELECTOR SWITCH

POSITION	FUNCTION
1	MIC.
2	NAB TAPE
3	RIAA, NAB, ORTHO
4	TUNER
5	EXTRA

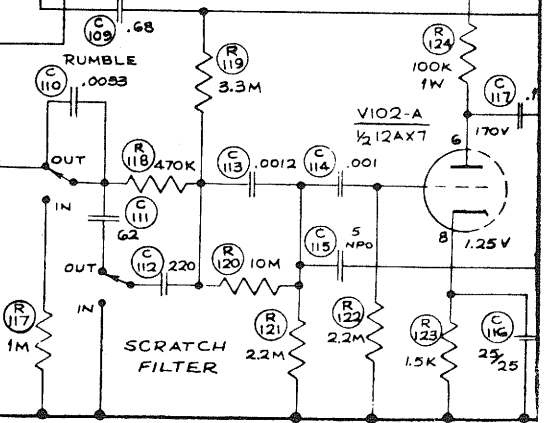
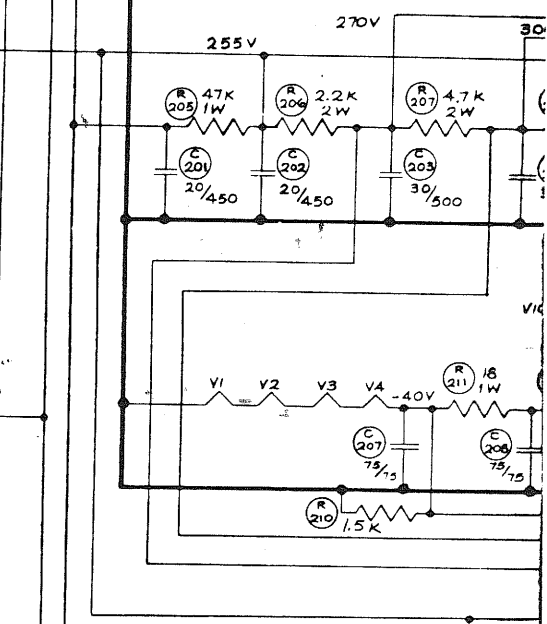
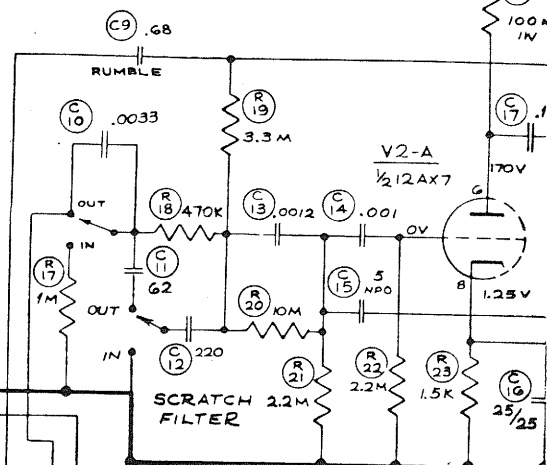
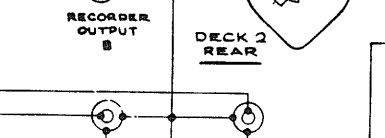
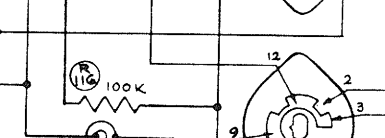
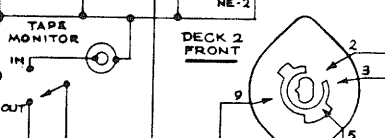
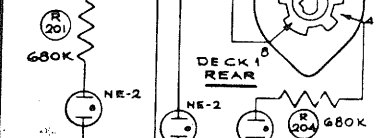
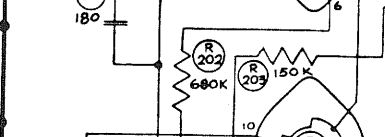
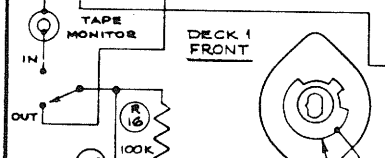
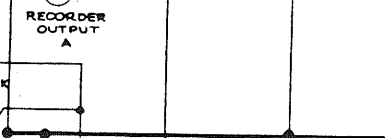
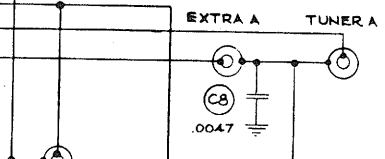
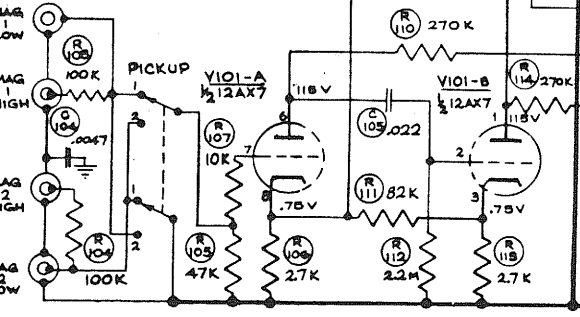
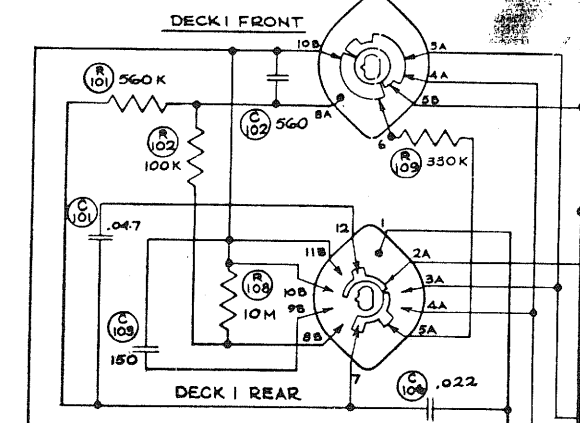

REVISIONS	REVISIONS
1	4
2	3
3	2
4	1

THE FOLLOWING MECHANICALLY CONTROLS IN CA
 1. INPUT SEL.
 2. EQUALIZER
 3. SCRATCH
 4. LOUDNESS
 5. CUDNLS

SONIC UNITS
HAVE 6U8

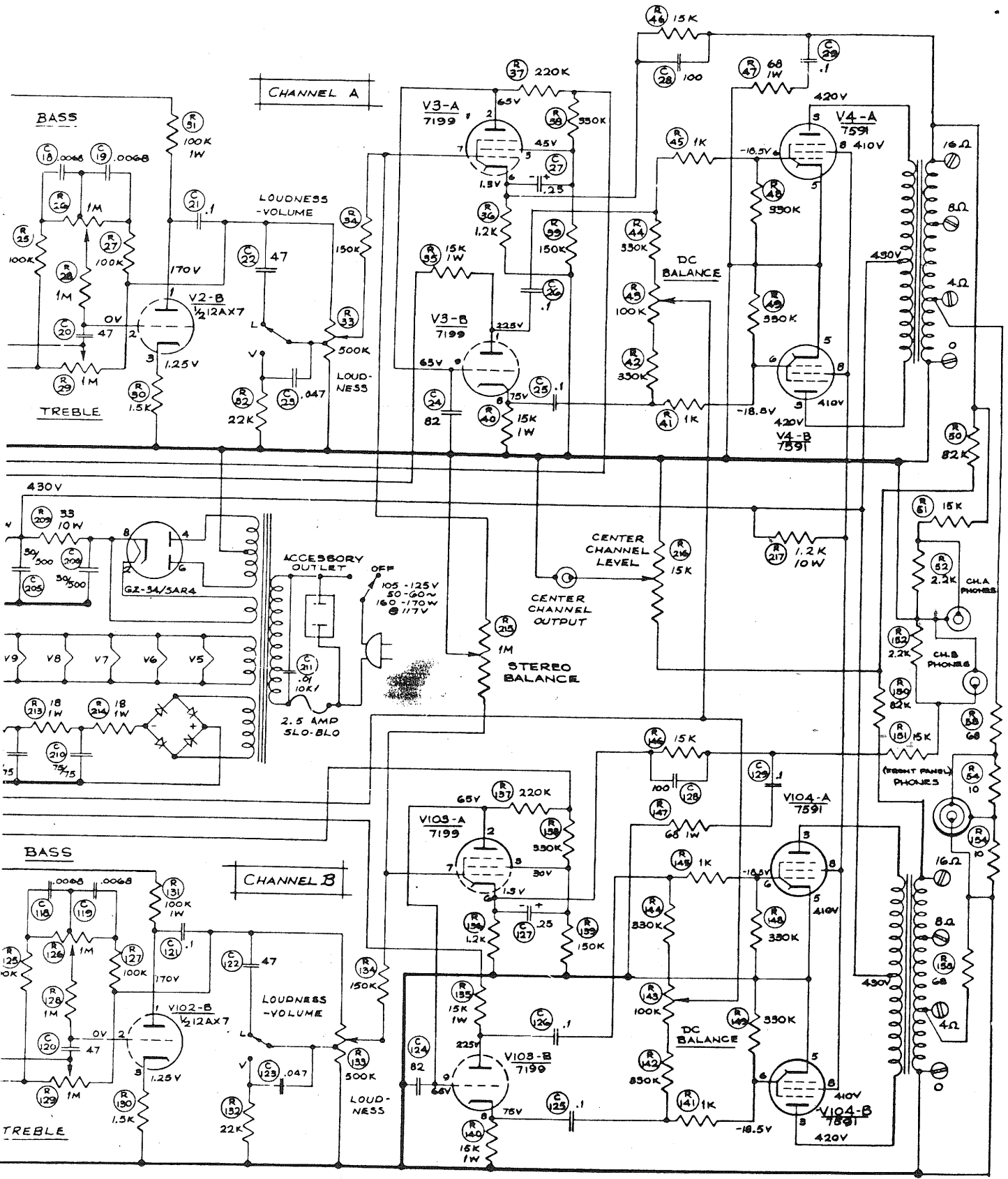

OLS IN CHANNEL A ARE IDENTICAL WITH IDENTICAL L-B

TYPE 299C STEREO AMPLIFIER

UNLESS OTHERWISE SPECIFIED
ALL DIMENSIONS ARE IN INCHES
TOLERANCE ON DECIMAL DIMENSIONS - 1/64
TOLERANCE ON ANGULAR DIMENSIONS - 90°
BREAK SHARP CORNERS

SCALE: NONE	CIRCUIT DIAGRAM	6/2/61
H. H. SCOTT, INC. MAYNARD, MASS., U.S.A.		
DR. R. M. D. R.	ENG. <i>M. M.</i>	DWG. NUMBER D-299C-C1 SUB. Q
CH.	PROD.	

1ME
POWER SWITCH