

OPERATING INSTRUCTIONS

BEDIENUNGSANLEITUNG

 **Sherwood**

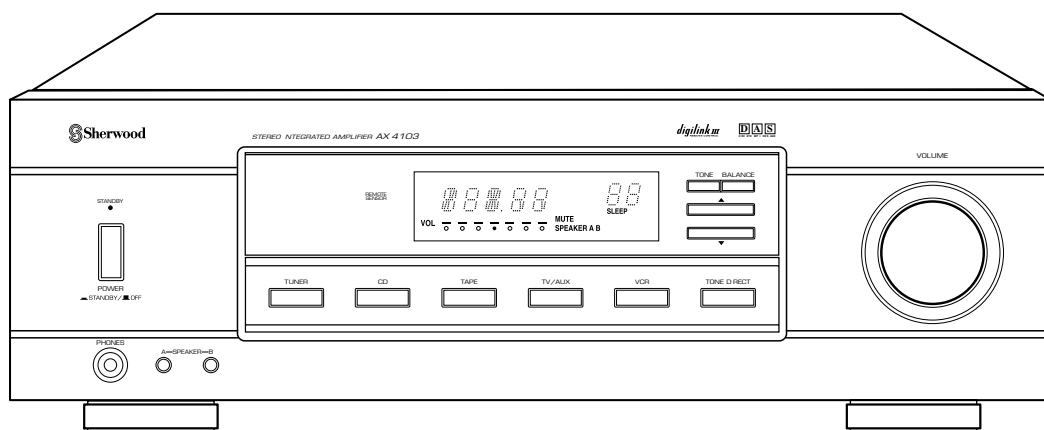

AX-4103

STEREO INTEGRATED AMPLIFIER
INTEGRIERTER STEREO VOR-/ENDVERSTÄRKER

CE



Introduction

UNPACKING AND INSTALLATION

Congratulations on Your Purchase!

Your new high fidelity amplifier is designed to deliver maximum enjoyment and years of trouble free service. Please take a few moments to read this manual thoroughly. It will explain the features and operation of your unit and help ensure a trouble free installation. Please unpack your unit carefully. We recommend that you save the carton and packing material. They will be helpful if you ever need to move your unit and may be required if you ever need to return it for service. Your unit is designed to be placed in a horizontal position and it is important to allow at least two inches of space behind your unit for adequate ventilation and cabling convenience.

To avoid damage, never place the unit near radiators, in front of heating vents, in direct sunlight, or in excessively humid or dusty locations. Connect your complementary components as illustrated in the following section.

	CAUTION RISK OF ELECTRIC SHOCK DO NOT OPEN	
CAUTION : TO REDUCE THE RISK OF ELECTRIC SHOCK, DO NOT REMOVE COVER (OR BACK). NO USER-SERVICEABLE PARTS INSIDE. REFER SERVICING TO QUALIFIED SERVICE PERSONNEL.		



This symbol is intended to alert the user to the presence of uninsulated "dangerous voltage" within the product's enclosure that may be of sufficient magnitude to constitute a risk of electric shock to persons.



This symbol is intended to alert the user to the presence of important operating and maintenance (servicing) instructions in the literature accompanying the appliance.

WARNING

To reduce the risk of fire or electric shock, do not expose this appliance to rain or moisture.

Caution : Do not block ventilation openings or stack other equipment on the top.

FOR U.S.A

■ FCC INFORMATION

This equipment has been tested and found to comply with the limits for a Class B digital device, pursuant to Part 15 of the FCC Rules. These limits are designed to provide reasonable protection against harmful interference in a residential installation. This equipment generates, uses and can radiate radio frequency energy and, if not installed and used in accordance with the instructions, may cause harmful interference to radio communications. However, there is no guarantee that interference will not occur in a particular installation. If this equipment does cause harmful interference to radio or television reception, which can be determined by turning the equipment off and on, the user is encouraged to try to correct the interference by one or more of the following measures:

- Reorient or relocate the receiving antenna.
- Increase the separation between the equipment and amplifier.
- Connect the equipment into an outlet on a circuit different from that to which the amplifier is connected.
- Consult the dealer or an experienced radio/TV technician for help.

CAUTION: Any changes or modifications in construction of this device which are not expressly approved by the party responsible for compliance could void the user's authority to operate the equipment.

Caution regarding placement (Except for U.S.A. and Canada)

To maintain proper ventilation, be sure to leave a space around the unit (from the largest outer dimensions including projections) equal to, or greater than, shown below.



- Left and right panels: 5 cm
- Rear panel: 10 cm
- Top panel: 20 cm

READ THIS BEFORE OPERATING YOUR UNIT

FOR U.S.A AND CANADA 120 V

FOR YOUR SAFETY

Units shipped to the U.S.A and Canada are designed for operation on 120 V AC only.

Safety precaution with use of a polarized AC plug. However, some products may be supplied with a nonpolarized plug.

CAUTION : *To prevent electric shock, match wide blade of plug to wide slot, fully insert.*

ATTENTION : *Pour éviter les choc électriques, introduire la lame la plug large de la borne correspondante de la prise et pousse jusqu'au fond.*

FOR CHINA, EUROPE AND AUSTRALIA 220V/230V/240V

FOR YOUR SAFETY

Units shipped to China are designed for operation on 220 V AC only.

Units shipped to Australia are designed for operation on 240 V AC only.

To ensure safe operation, the three-pin plug supplied must be inserted only into a standard three-pin power point which is effectively earthed through the normal household wiring. Extension cords used with the equipment must be three-core and be correctly wired to provide connection to earth.

Improper extension cords are a major cause of fatalities. The fact that the equipment operates satisfactorily does not imply that the power point is earthed and that the installation is completely safe. For your safety, if in any doubt about the effective earthing of the power point, consult a qualified electrician.

PAN-EUROPEAN UNIFIED VOLTAGE

All units are suitable for use on supplies 230-240 V AC.

FOR OTHER COUNTRIES 115 V/230 V

FOR YOUR SAFETY

Units shipped to countries other than the above countries are equipped with an AC voltage selector switch on the rear panel. Refer to the following paragraph for the proper setting of this switch.

AC VOLTAGE SELECTION

This unit operates on 115/230 V AC. The AC voltage selector switch on the rear panel is set to the voltage that prevails in the area to which the unit is shipped. Before connecting the power cord to your AC outlet, make sure that the setting position of this switch matches your line voltage. If not, it must be set to your voltage in accordance with the following direction.

AC voltage selector switch

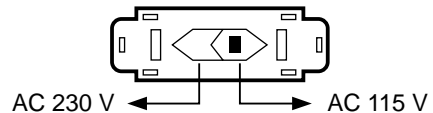

Move switch lever to match your line voltage with a small screwdriver or other pointed tool.

CONTENTS

Introduction

- UNPACKING AND INSTALLATION 2
- READ THIS BEFORE OPERATING YOUR UNIT 3

System Connections 5

Front Panel & System Remote Controls 7

- REMOTE CONTROL OPERATION RANGE 9
- LOADING BATTERIES 9

Operations

- LISTENING TO A PROGRAM SOURCE 10
- RECORDING 12
- OTHER FUNCTIONS 12

Troubleshooting Guide 13

Specifications 13

System Connections

- Do not plug the AC input cord into the wall AC outlet until all connections are completed.
- Be sure to connect the white RCA pin cord to the L(left) and the red RCA pin cord to the R(right) jacks when making audio connections.
- Make connections firmly and correctly. If not, it can cause loss of sound, noise or damage to the amplifier.
- If the electricity fails or the AC input cord is left unplugged for more than 2 weeks, the memorized contents will be cleared. Should this happen, memorize them again.

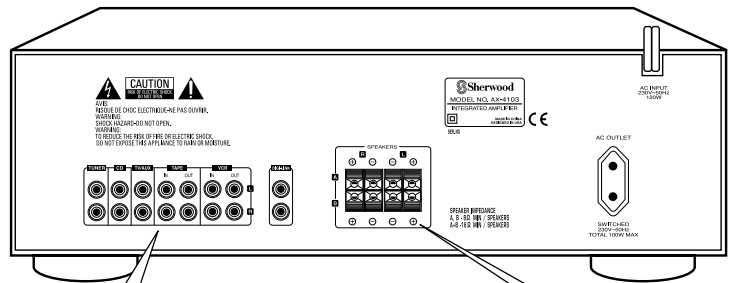

CONNECTING AUDIO/VIDEO COMPONENTS

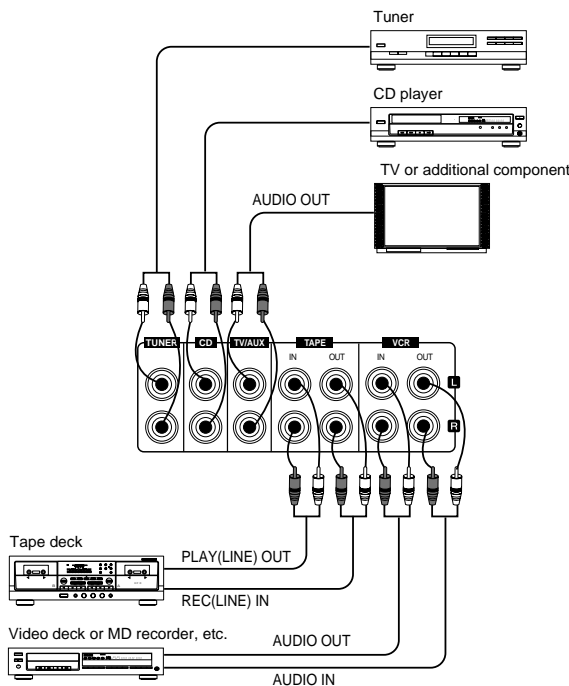

- The VCR jacks may also be connected to an additional component such as MD recorder, tape deck, etc.
- The TV/AUX jacks may also be connected to an additional component such as a TV, DVD player, etc.

CONNECTING SPEAKERS

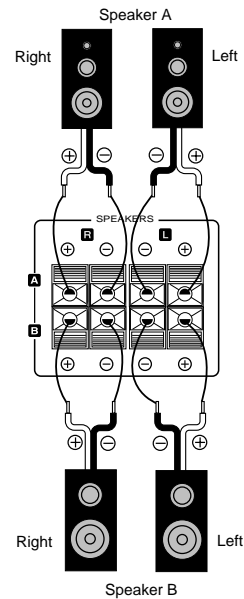

- Usually SPEAKER A terminals are used for only a pair of speakers. When you have another pair of speakers, SPEAKER B terminals can be used.
- Never short-circuit the + and - speaker cords.
- Be sure to connect speakers firmly and correctly according to the channel (left and right) and the polarity (+ and -).
- Note :
 - For safe amplifier operation, use the speakers with impedance of over 8Ω when you use only SPEAKER A or B terminals and use the speakers with impedance of over 16Ω when you use both SPEAKER A and B terminals.

■ AC INPUT CORD

Plug this cord into a wall AC outlet.

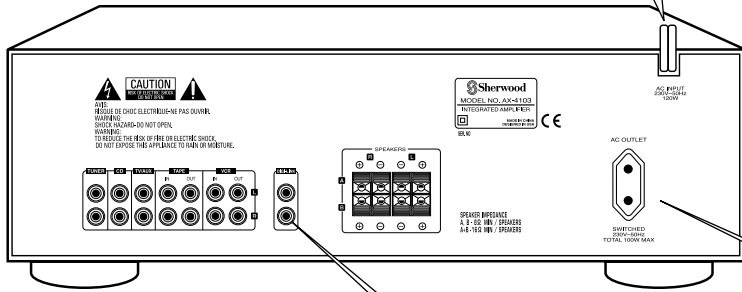

■ CONNECTING SYSTEM CONTROL

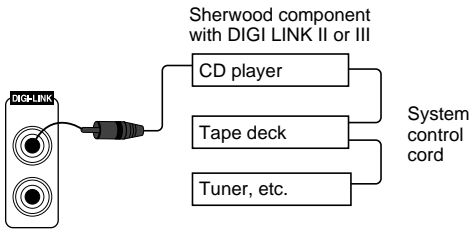

- Connect this jack to the DIGI LINK jack of the external Sherwood component that uses the DIGI LINK II or III remote control system.

■ SWITCHED AC OUTLET

- This outlet is switched on (power-on mode) and off (standby mode) according to power control as follows (Maximum total capacity is 100W):

- Standby mode — switched AC outlet off
 - Power-on mode — switched AC outlet on

Front Panel & System Remote Controls

Front Panel Controls

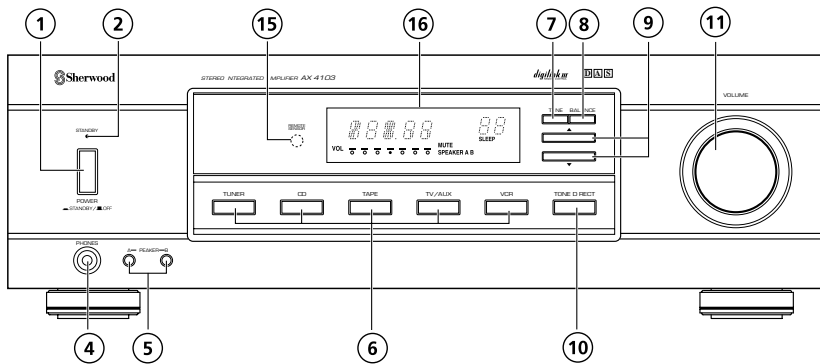

System Remote Controls

- You can remotely control not only this amplifier but also Sherwood compatible components bearing the DIGI LINK II or III logo.
- For system remote control operation, first make the DIGI LINK connections.

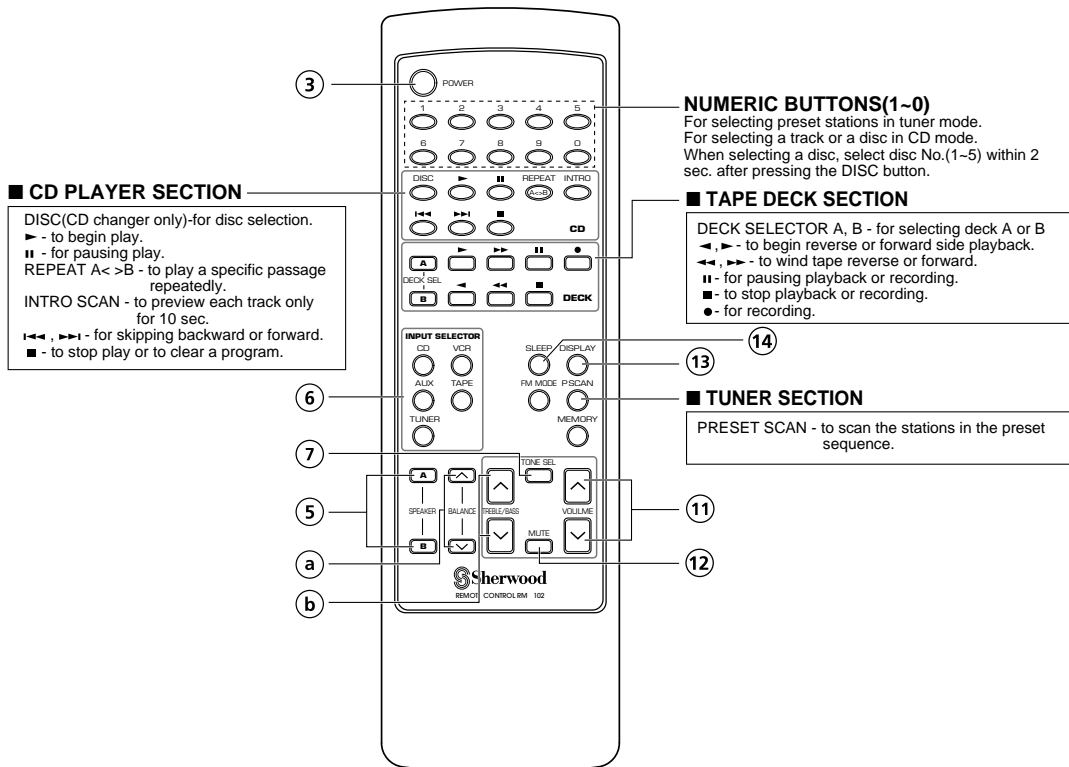

- In the DIGI LINK III remote control system, if pressing PLAY, etc. on CD player or tape deck, CD or TAPE is selected automatically without selecting the input source and then PLAY, etc. starts.

Notes:

- The FM MODE and MEMORY buttons for tuner function are not available for this unit.
- Some functions for a CD player or tape deck, etc. may not be available.
- For details about functions, refer to the operating instructions of each component.

① POWER SWITCH

Push this switch to enter the standby mode.
To switch the power off, push again this switch.

② STANDBY INDICATOR**③ POWER BUTTON**

In the standby mode, press this button to turn the power on, then the STANDBY indicator goes off.
Press again this button to turn the power off, then the STANDBY indicator lights up.

④ HEADPHONE JACK

Stereo headphones with a standard 1/4 inch plug can be plugged into this jack for private listening.

⑤ SPEAKER A, B SELECTOR BUTTONS

These buttons allow you to select various combinations of speakers as follows:

- To drive A speakers, press only the SPEAKER A button (“SPEAKER A” lights up).
- To drive B speakers, press only the SPEAKER B button (“SPEAKER B” lights up).
- To drive both A and B speakers, press the SPEAKER A and B buttons (“SPEAKER A” and “B” light up).
- When using headphones for private listening, press these buttons to switch off the speaker A and B (“SPEAKER A” and “B” go off).

⑥ INPUT SELECTOR BUTTONS

Press the button to select the desired input source.

⑦ TONE BUTTON

When adjusting the tone (bass and treble), press this button to select the desired tone mode.

- Each time this button is pressed, the tone mode is changed to bass or treble.

⑧ BALANCE BUTTON

When adjusting the sound volume balance, press this button to enter the balance mode.

⑨ BALANCE, TREBLE/BASS UP/DOWN**(▲/▼, ∧/∨) BUTTONS**

- ⓐ At the balance mode, adjust the sound volume balance between left and right speakers with these buttons.
- When the BALANCE ∧/∨ buttons on the remote control are pressed, it enters the balance mode automatically without pressing the BALANCE button on the front panel.
- ⓑ At the desired tone mode, adjust the tone as desired with these buttons.

⑩ TONE DIRECT BUTTON

Press this button to listen to a program source without the tone effect.

⑪ VOLUME CONTROL KNOB, UP/DOWN(∧/∨) BUTTONS

Adjust the volume to a comfortable listening level with this knob or these buttons.

⑫ MUTE BUTTON

Press this button to temporarily mute the sound.
Press again to resume the previous sound level.

⑬ DISPLAY BUTTON

Press this button to select the brightness of the fluorescent displays as desired.

- Each time this button is pressed, the brightness of all fluorescent displays of Sherwood components connected by the DIGI LINK III changes together as follows:

→ ON → dim → OFF →

⑭ SLEEP BUTTON

Press this button to activate the sleep timer for a specified period of time.

- Each time this button is pressed, the sleep time changes as follows:

→ 10 → 20 → 30 → 60 → 90 → OFF →
Unit : minutes

⑮ REMOTE SENSOR

This receives the signals from the remote control unit.

⑯ FLUORESCENT DISPLAY

For details, see the next page.

■ FLUORESCENT DISPLAY

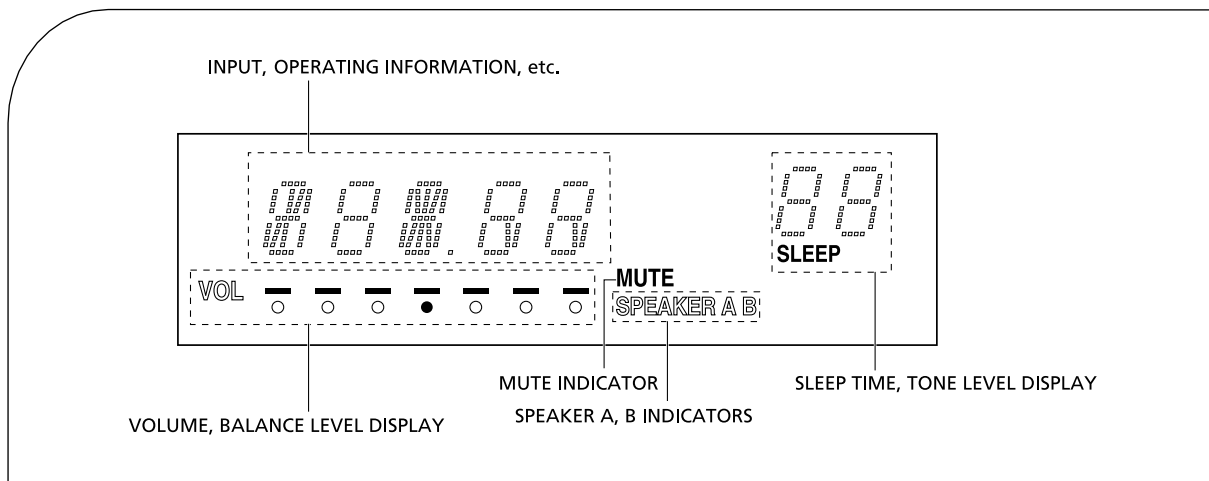

REMOTE CONTROL OPERATION RANGE

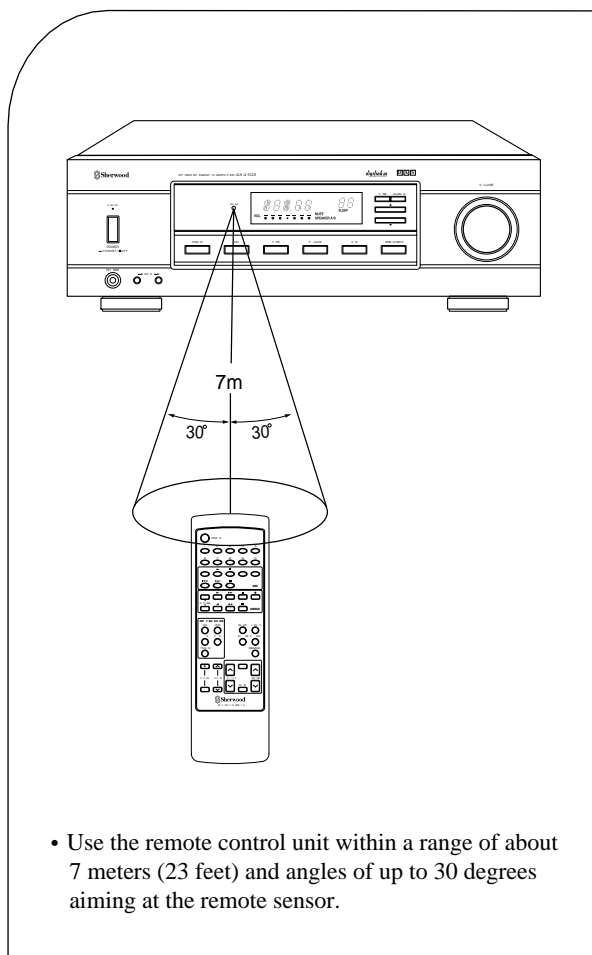

LOADING BATTERIES

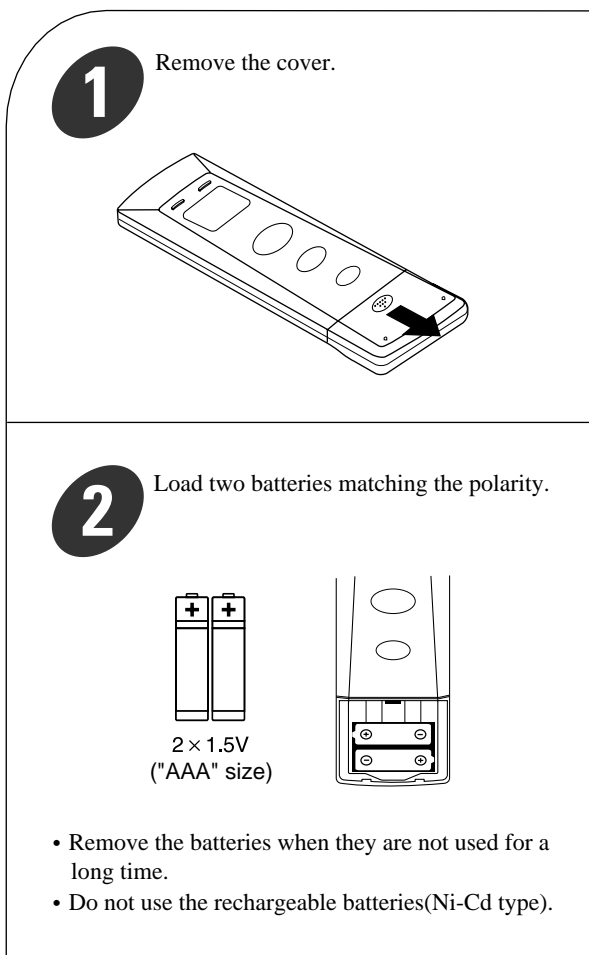

Operations

LISTENING TO A PROGRAM SOURCE

Before operation

- Enter the standby mode.

- The STANDBY indicator lights up. This means that the amplifier is not disconnected from the AC mains and a small amount of current is retained to support the memorized contents and operation readiness.
- To switch the power off, push the POWER switch again, then the power is cut off and the STANDBY indicator goes off.



3 Select the desired input source.

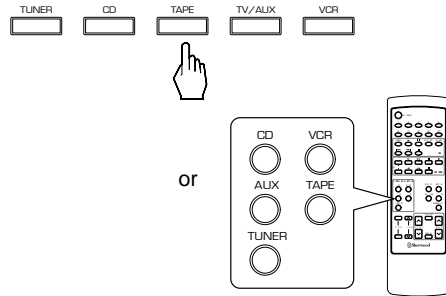

1

In the standby mode, turn the power on.

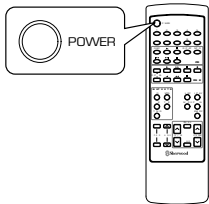

- Each time the POWER button on the remote control is pressed, this unit is turned on to enter the operating mode or off to enter the standby mode.
- In the standby mode, if an INPUT SELECTOR button is pressed, the unit is turned on automatically and the desired input is selected.

4

Operate the selected component for playback.

5

Adjust the volume to a comfortable listening level.

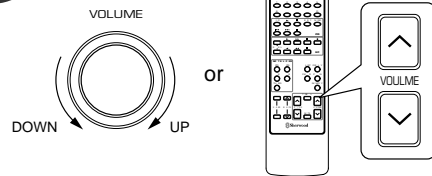

2

Switch the desired speakers on.

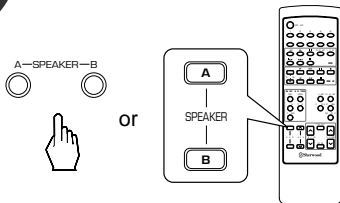

- Then the corresponding speaker indicator lights up and the sound can be heard from the speakers connected to the selected speaker terminals.
- When using the headphones for private listening, press the corresponding SPEAKER button to switch off both A and B speakers.

6

To mute the sound.

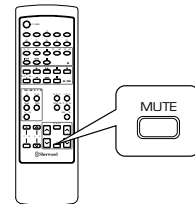

- “MUTE” lights up and “SPEAKER” flickers.
- To resume the previous sound level, press this button again.

7

To listen with the headphones.

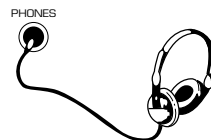

- Be sure to switch off both A and B speakers.

Adjusting the tone(bass and treble)

8 Enter the tone mode.

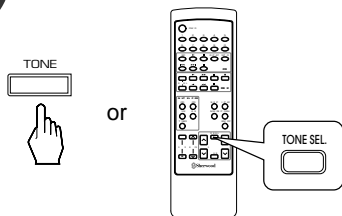

- Each time this button is pressed, the corresponding tone mode is selected and shown for 5 seconds as follows:

→ BAS(s) → TRE(ble)

■ Note:

- When the tone direct function is activated, the tone mode cannot be entered and “T-DIR” is displayed.

9 At the desired tone mode, adjust the tone as desired.

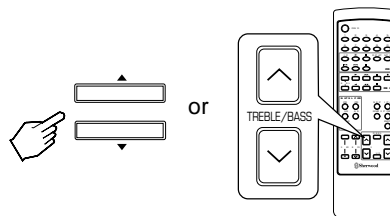

- If the tone display disappears, start from the step 8 again.

■ Notes:

- Extreme settings at high volume may damage your speakers.
- In general, the bass and treble levels are adjusted to 0.

10 To listen to a program source without the tone effect.



- “T-DIR” is displayed and the sound that bypasses the tone circuitry will be heard.
- To cancel the tone direct function, press this button again to display “D-OFF”.

Adjusting the sound volume balance

11 Enter the balance mode.



- “BAL” is displayed for 5 seconds.

12 Adjust the sound volume balance between the left and right speakers.

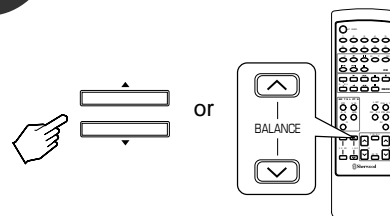

- If the balance display disappears, start from the step 11 again.
- When the BALANCE \wedge/\vee buttons on the remote control are pressed, it enters the balance mode automatically without pressing the BALANCE button on the front panel.

■ Note:

- In general, the balance level is set to the center position(red dot).

RECORDING

- The volume, tone(bass, treble) and balance settings have no effect on the recording signals.
- When you select tuner, CD or AUX as a recording source, recording may be made on TAPE or VCR, or both simultaneously.

Recording with TAPE

1 Select the desired input as a recording source except for TAPE.

or

Recording with VCR

1 Select the desired input as a recording source except for VCR.

or

2 Start recording on the TAPE.

2 Start recording on the VCR.

3 Start play on the desired input.

3 Start play on the desired input.

- The audio signals from the desired input will be recorded onto the VCR.

OTHER FUNCTIONS

Operating the sleep timer

- The sleep timer allows the amplifier to continue to operate for a specified period of time before automatically shutting off.
 - To set this unit to automatically turn off after the specified period of time.
-
- Each time this button is pressed, the sleep time changes as follows:

→ 10 → 20 → 30 → 60 → 90 → OFF
Unit : minutes
 - While operating the sleep timer, "SLEEP" lights up.
 - When the sleep time is selected, all display panels of Sherwood components connected by the DIGI LINK III are dimly lit.

Adjusting the brightness of the fluorescent displays

-
- Each time this button is pressed, the brightness of all fluorescent displays of Sherwood components connected by the DIGI LINK III changes together as follows:

→ ON → dim → OFF

 - In the display OFF mode, pressing any button will restore the display ON mode.

Troubleshooting Guide

If a fault occurs, run through the table below before taking your amplifier for repair. If the fault persists, attempt to solve it by switching the amplifier off and on again. If this fails to resolve the situation, consult your dealer. Under no circumstances should you repair the amplifier yourself as this could invalidate the warranty.

PROBLEM	POSSIBLE CAUSE	REMEDY
No power	<ul style="list-style-type: none"> The AC input cord is disconnected. Poor connection at AC wall outlet or the outlet is inactive. 	<ul style="list-style-type: none"> Connect the cord securely. Check the outlet using a lamp or another appliance.
No sound	<ul style="list-style-type: none"> The speaker cords are disconnected. The volume is adjusted too low. The MUTE button on the remote control is pressed to ON. Speakers are not switched on. Incorrect selection of the input source. Incorrect connections between the components. 	<ul style="list-style-type: none"> Check the speaker connections. Adjust the volume. Press the MUTE button to cancel the muting effect. Press the SPEAKER A or B button to ON. Select the desired input source correctly. Make connections correctly.
No recording	<ul style="list-style-type: none"> Incorrect selection between the components. Incorrect operation of each component for playback and recording. 	<ul style="list-style-type: none"> Make connections correctly. Operate each component correctly.
Remote control unit does not operate.	<ul style="list-style-type: none"> Batteries are not loaded or exhausted. The remote sensor is obstructed. 	<ul style="list-style-type: none"> Replace the batteries. Remove the obstacle.

Specifications

■ AMPLIFIER SECTION

- Power output, stereo mode, 8 Ω, THD 0.3 %, 40 Hz~20 kHz 2 × 53 W
- Total harmonic distortion, 8 Ω, 53 W, 1 kHz 0.05 %
- Intermodulation distortion
60 Hz : 7 kHz= 4 : 1 SMPTE, 8 Ω, 53 W 0.03 %
- Input sensitivity, 47 kΩ
Line 200 mV
- Signal to noise ratio, IHF “A” weighted
Line 95 dB
- Frequency response
Line, 20 Hz~40 kHz ±3 dB
- Output level
TAPE/VCR OUT, 2.2 kΩ 200 mV
- Bass/Treble control, 100 Hz/10 kHz ±10 dB

■ GENERAL

- Power supply AC 230 V, 50 Hz
- Power consumption 120 W
- Dimensions(W × H × D) 440 × 138 × 332 mm(17-3/8 × 5-7/16 × 13 inches)
- Weight(Net) 8.0 kg(17.6 lbs)

Note: Design and specifications are subject to change without notice for improvements.

O P E R A T I N G I N S T R U C T I O N S



AX-4103

**STEREO INTEGRATED AMPLIFIER
INTEGRIERTER STEREO VOR-/ENDVERSTÄRKER**