



OPERATING INSTRUCTIONS
BEDIENUNGSANLEITUNG

R-903 / R-903R

**DIGITAL A/V RECEIVER
DIGITAL SURROUND STEREO-RECEIVER**





R-903 / R903R
DIGITAL A/V RECEIVER



5707-21061-002-0

Introduction

READ THIS BEFORE OPERATING YOUR UNIT

	 <p>This symbol is intended to alert the user to the presence of uninsulated "dangerous voltage" within the product's enclosure that may be of sufficient magnitude to constitute a risk of electric shock to persons.</p>
<p>CAUTION : TO REDUCE THE RISK OF ELECTRIC SHOCK, DO NOT REMOVE COVER (OR BACK). NO USER-SERVICEABLE PARTS INS DE. REFER SERVICING TO QUALIFIED SERVICE PERSONNEL.</p>	 <p>This symbol is intended to alert the user to the presence of important operating and maintenance (servicing) instructions in the literature accompanying the appliance.</p>

WARNING : TO REDUCE THE RISK OF FIRE OR ELECTRIC SHOCK, DO NOT EXPOSE THIS APPLIANCE TO RAIN OR MOISTURE.

Caution regarding placement
 To maintain proper ventilation, be sure to leave a space around the unit (from the largest outer dimensions including projections) equal to, or greater than, shown below.

Left and right panels: 5 cm
 Rear panel: 10 cm
 Top panel: 20 cm

Do not block ventilation openings or stack other equipment on the top.

FOR YOUR SAFETY		
<p>EUROPE AUSTRALIA</p>	<p>220 V - 240 V</p>	<p>Units shipped to Australia are designed for operation on 240 V AC only. To ensure safe operation, the three-pin plug supplied must be inserted only into a standard three-pin power point which is effectively earthed through the normal household wiring. Extension cords used with the equipment must be three-core and be correctly wired to provide connection to earth. Improper extension cords are a major cause of fatalities. The fact that the equipment operates satisfactorily does not imply that the power point is earthed and that the installation is completely safe. For your safety, if in any doubt about the effective earthing of the power point, consult a qualified electrician. PAN-EUROPEAN UNIFIED VOLTAGE All units are suitable for use on supplies 220-240 V AC.</p>
<ul style="list-style-type: none"> • Avoid high temperatures. Allow for sufficient heat dispersion when installed on a rack. • Keep the set free from moisture, water, and dust. • Do not let foreign objects in the set. • Handle the power cord carefully. Hold the plug when unplugging the cord. • Unplug the power cord when not using the set for long periods of time. • Do not obstruct the ventilation holes. • Do not let insecticides, benzene, and thinner come in contact with the set. • Never disassemble or modify the set in any way. 		

CAUTION

- The ventilation should not be impeded by covering the ventilation openings with items, such as newspapers, table-cloths, curtains, etc.
- No naked flame sources, such as lighted candles, should be placed on the apparatus.
- Please be care the environmental aspects of battery disposal.
- The apparatus shall not be exposed to dripping or splashing for use.
- No objects filled with liquids, such as vases, shall be placed on the apparatus.

ENGLISH

CONTENTS

ENGLISH

- **Introduction**
 - READ THIS BEFORE OPERATING YOUR UNIT | 3
- **System Connections** | 5
- **Front Panel Controls** | 9
- **Universal Remote Controls** | 10
 - OPERATING COMPONENTS WITH REMOTE CONTROL | 12
 - REMOTE CONTROL OPERATION RANGE | 12
 - LOADING BATTERIES | 12
 - USING FUNCTIONS OF REMOTE CONTROL | 13
- **Before Operation**
 - SURROUND SOUND | 16
- **Operations**
 - TURNING THE POWER ON/OFF | 21
 - LISTENING TO A PROGRAM SOURCE | 22
 - ENJOYING SURROUND SOUND | 24
 - LISTENING TO RADIO BROADCASTS | 31
 - LISTENING TO RDS BROADCASTS (FM ONLY) | 33
 - ANALOG AUDIO/VIDEO RECORDING | 35
 - DIGITAL AUDIO RECORDING WITH MD RECORDER | 36
 - OTHER FUNCTIONS | 37
- **Using the OSD**
 - CURRENT STATUS DISPLAY | 38
 - MENU SCREEN | 38
- **Troubleshooting Guide** | 41
- **Specifications** | 42
- **Appendix**
 - INITIALIZING THE SYSTEM | 43
 - SETTING UP THE SYSTEM ON FRONT PANEL | 43
 - SETUP CODE TABLE | 45

System Connections

- Do not plug the AC input cord into the wall AC outlet until all connections are completed.
- Be sure to observe the color coding when connecting audio and video cords.
- Make connections firmly and correctly. If not, it can cause loss of sound, noise or damage to the receiver.

ENGLISH

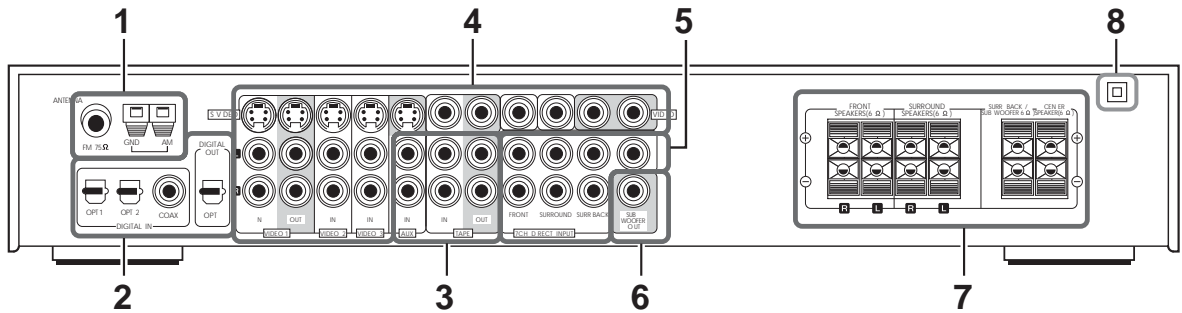

1. CONNECTING ANTENNAS

FM Indoor Antenna

FM Outdoor Antenna

- Change the position of the FM indoor antenna until you get the best reception of your favorite FM stations.
- A 75Ω outdoor FM antenna may be used to further improve the reception. Disconnect the indoor antenna before replacing it with the outdoor one.

AM Loop Antenna

AM Outdoor Antenna

- Place the AM loop antenna as far as possible from the receiver, TV set, speaker cords and the AC input cord and set it to a direction for the best reception.
- If the reception is poor with the AM loop antenna, an AM outdoor antenna can be used in place of the AM loop antenna.

2. CONNECTING DIGITAL INs and OUT

- The COAXIAL or the OPTICAL DIGITAL OUTs of the components that are connected to AUX and VIDEO 1~3 of this unit can be connected to these DIGITAL INs.
- If a digital recorder or other component with OPTICAL DIGITAL IN/OUT jacks is connected to the corresponding jacks of this unit, you can playback and/or record the high quality sound of CD's, etc. without analog conversion or degradation.
- A digital input should be connected to the components such as a CD player, LD player, DVD player, etc. capable of outputting DTS Digital Surround, Dolby Digital or PCM format digital signals, etc.
- For details, refer to the operating instructions of the component connected.
- When making the COAXIAL DIGITAL connection, be sure to use a 75Ω COAXIAL cord, not a conventional AUDIO cord.
- All of the commercially available optical fiber cords cannot be used for the equipment. If there is an optical fiber cord which cannot be connected to your equipment, consult your dealer or nearest service organization.

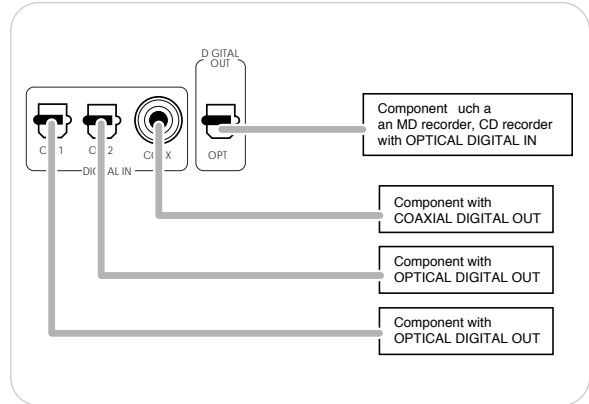

3. CONNECTING AUDIO COMPONENTS

- The AUX jacks may be connected to an additional audio component such as a CD player, a tape deck, etc.
- The TAPE IN/OUT jacks can be connected to PLAY(OUT) / REC(IN) jacks of MD recorder.

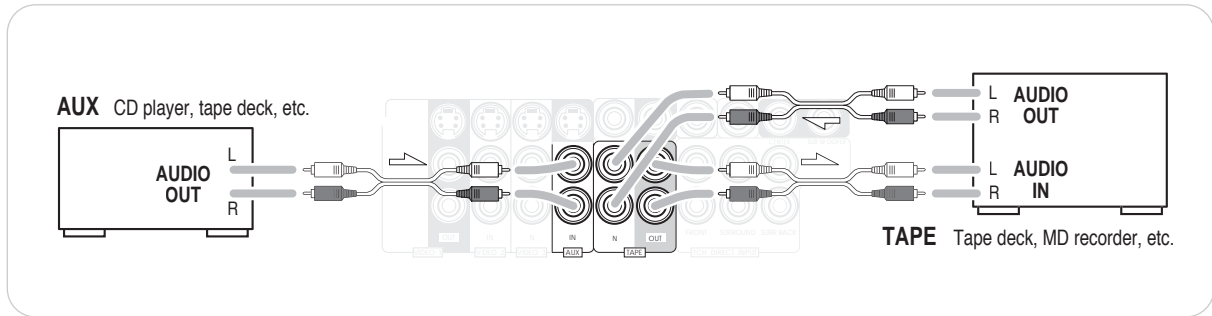

4. CONNECTING VIDEO COMPONENTS

- This unit incorporates S-VIDEO and composite (normal) VIDEO jacks.
For your reference, the excellence in picture quality is as follows: "S-VIDEO" > composite(normal) "VIDEO"
- A signal input into the composite(normal) VIDEO IN jack will be output in the composite(normal) VIDEO OUT jacks and a signal input into the S-VIDEO IN jack will be output in the S-VIDEO OUT jacks and the composite (normal) MONITOR 1/2 VIDEO OUT jacks.
- The next picture is different from your real back panel; just for helping your understanding.
When you connecting the components on the real back panel, refer to the sticker on top cover.

VIDEO 1 VCR, DVD player/recorder, etc.

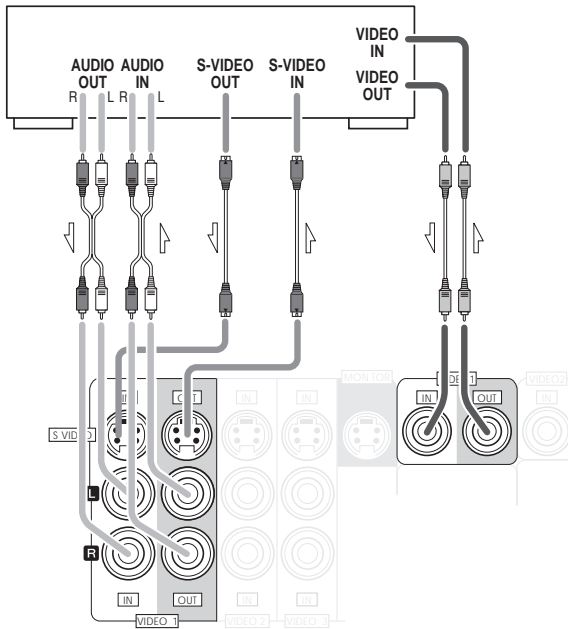

- The jacks of VIDEO 1 may also be connected to a VCR, DVD recorder or other digital video recording component. For details, refer to the operating instructions of the component to be connected.

- The jacks of VIDEO 2/VIDEO 3 can also be connected to an additional video component such as a cable TV tuner, an LD player or satellite system.

MONITOR 2 Additional TV, projector, etc.

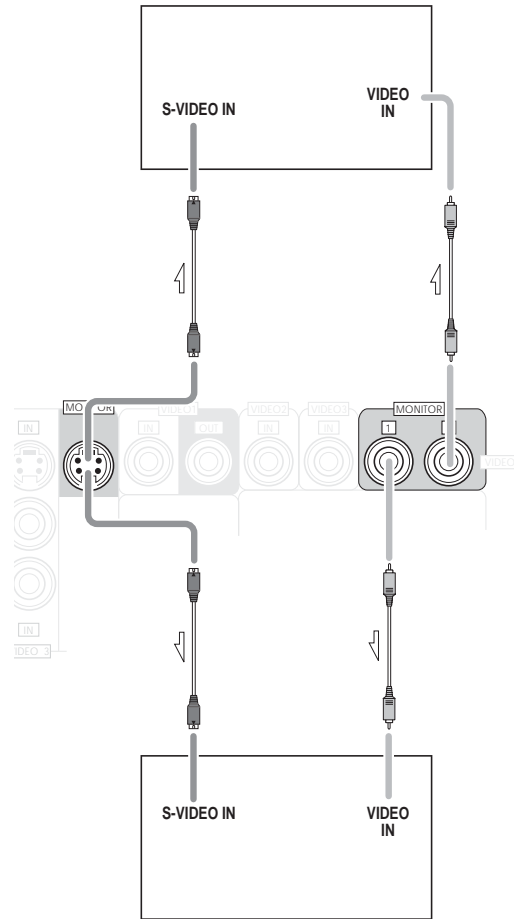

MONITOR 1 TV, projector, etc.

VIDEO 2 DVD player, VCR, etc.

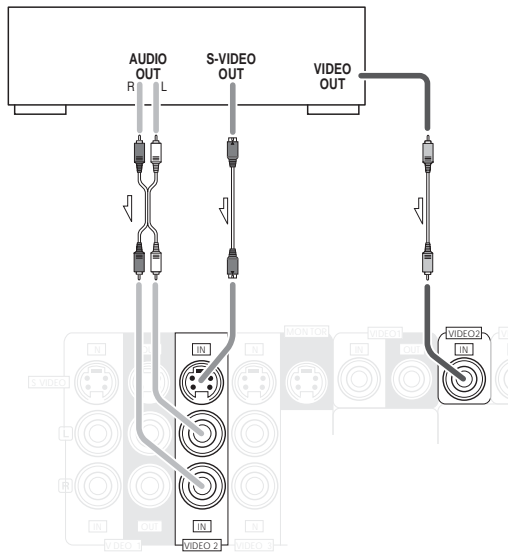

VIDEO 3 DVD player, VCR, etc.

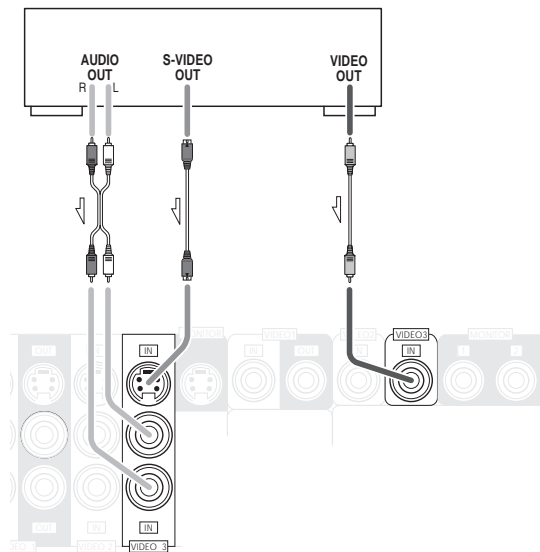

5. CONNECTING 7 CH DIRECT INPUTS

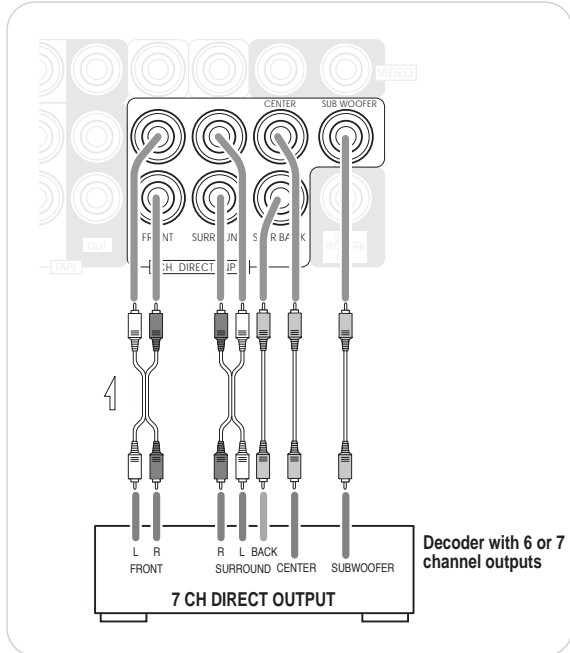

- Use these jacks to connect the corresponding analog outputs of a DVD player or external decoder, etc. that has 6 or 7 channel outputs.
- In case of 6 channel outputs, do not connect this SURROUND BACK input to your component. (For details, refer to the operating instructions of the component to be connected.)

6. SUBWOOFER PRE OUT connection

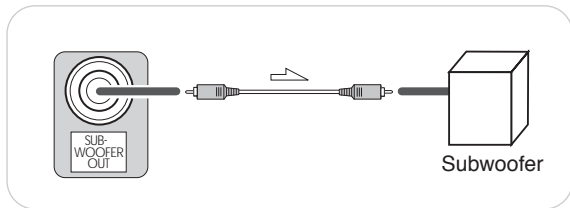

- To emphasize the deep bass sounds, connect a powered subwoofer.
- **Note** : When there is not surround back speaker, you can connect the subwoofer into the terminal of surround back speaker. In this case, you should change the subwoofer speaker setting. Refer to "Adjusting the speaker settings" on page 19.

7. CONNECTING SPEAKERS

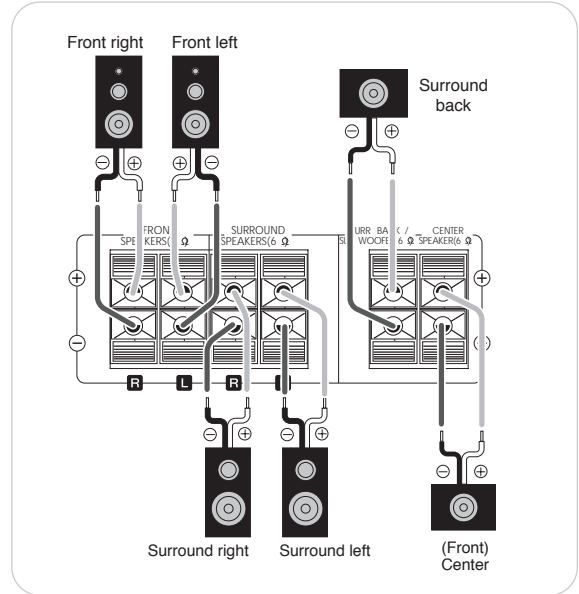

- Be sure to connect speakers firmly and correctly according to the channel (left and right) and the polarity (+ and -). If the connections are faulty, no sound will be heard from the speakers, and if the polarity of the speaker connection is incorrect, the sound will be unnatural and lack bass.
- For installing the speakers, refer to "Speaker placement" on page 18.
- After installing the speakers, first adjust the speaker settings according to your environment and speaker layout. (For details, refer to "Adjusting the speaker settings" on page 19.)

Caution :

- Be sure to use the speakers with the impedance of 6 ohms or above.
- Do not let the bare speaker wires touch each other or any metal part of this unit. This could damage this unit and/or the speakers.

8. AC INPUT CORD

- Plug this cord into a wall AC outlet.

Front Panel Controls

■ FLUORESCENT DISPLAY

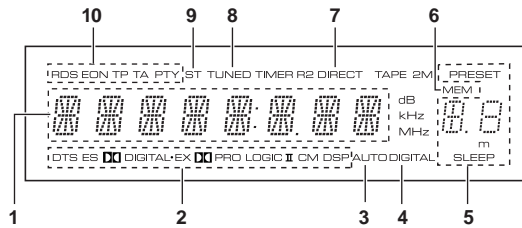

1. Input, frequency, volume level, operating information, etc.
2. Surround mode indicators
3. AUTO indicator
4. DIGITAL input signal indicator
5. PRESET number, SLEEP time, Speaker distance display
6. MEMory indicator
7. DIRECT indicator
8. TUNED indicator
9. STEREO indicator
10. RDS indicators

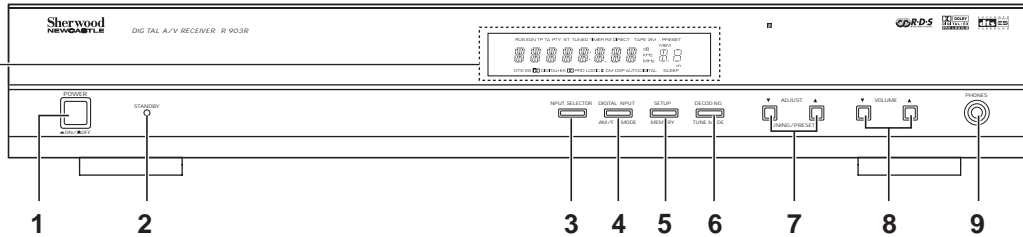

1. POWER switch
2. STANDBY indicator
3. INPUT SELECTOR button
4. DIGITAL INPUT/AM/FM MODE button
 - When digital signal(AUX, VIDEO1~3) is inputted, this button functions as digital input selector button.
 - When tuner is selected, this button functions as band selector button.
5. SETUP/MEMORY button
 - When pressing this button for a seconds, this button functions as setup button.
6. DECODING/TUNE MODE button
 - In setting mode, this button functions as sub mode button.
7. ADJUST/TUNING/PRESET UP(▲) / DOWN(▼) buttons
 - In setting mode, this button functions as ADJUST button.
8. VOLUME UP(▲) / DOWN(▼) buttons
9. HEADPHONE jack

Universal Remote Controls

ENGLISH

This universal remote control can operate not only this receiver but also most popular brands of audio and video components such as CD players, cassette decks, TVs, cable boxes, VCRs, DVD players, satellite receivers, etc.

- To operate 7 components other than this receiver, you should enter the setup code for each component.
(For details, refer to "USING FUNCTIONS OF REMOTE CONTROL" on page 13.)
- The numbered buttons on the remote control have different functions in different device modes. For details, refer to "FUNCTION TABLE of the NUMBERED BUTTONS" on the following page 11.

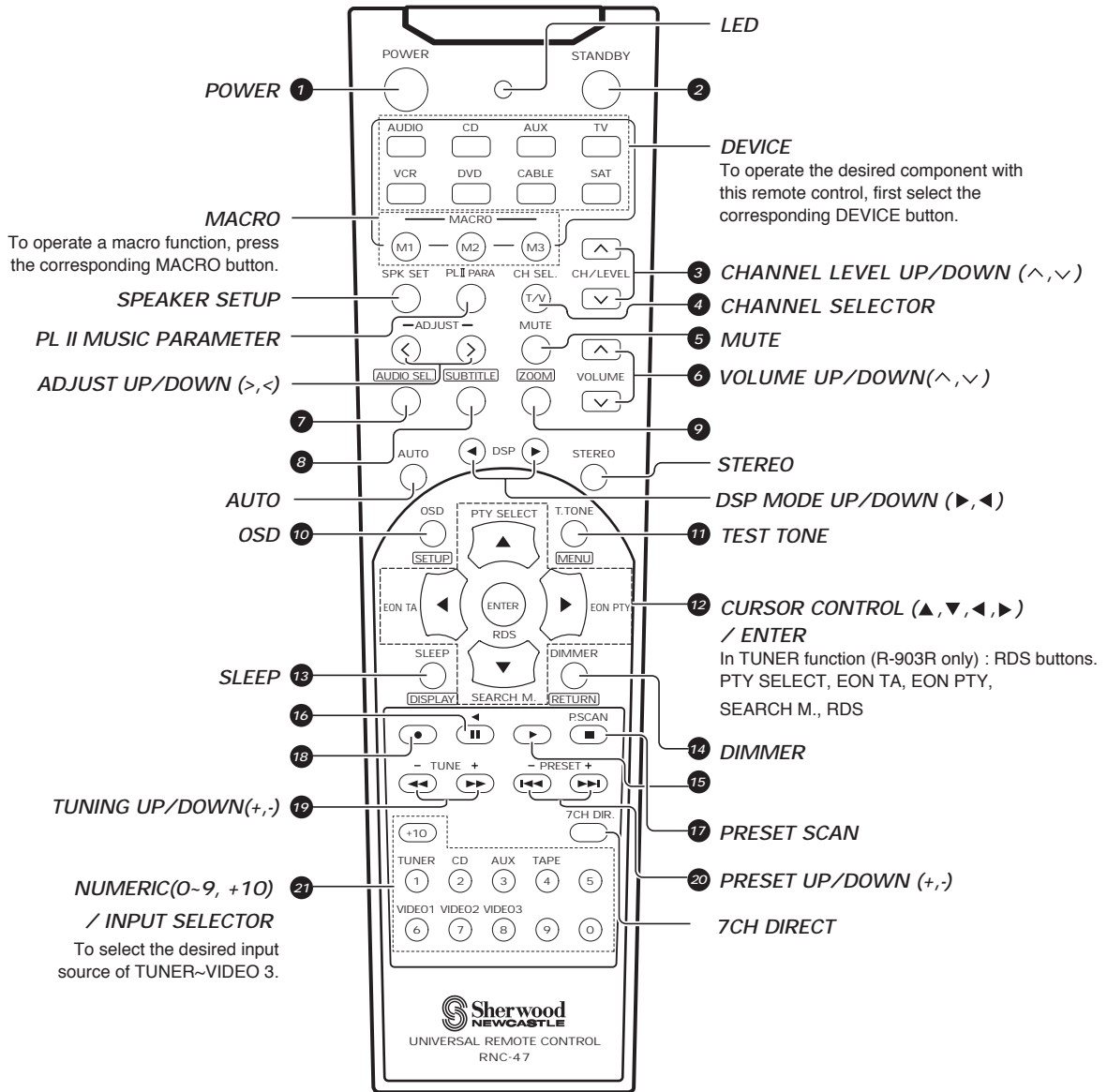

■FUNCTION TABLE of the NUMBERED BUTTONS

Device to be controlled Button symbol	CD (for CD player)	AUX (for tape deck)	TV (for TV)	VCR (for VCR)	DVD (for DVD player)	CABLE (for cable box)	SAT (for satellite receiver)
	①	POWER	POWER	POWER	POWER	POWER	POWER
②	STANDBY (POWER OFF)	STANDBY (POWER OFF)	STANDBY (POWER OFF)	STANDBY (POWER OFF)	STANDBY (POWER OFF)	STANDBY (POWER OFF)	STANDBY (POWER OFF)
③			CHANNEL LEVEL UP/DOWN (^/∨)	CHANNEL LEVEL UP/DOWN (^/∨)		CHANNEL LEVEL UP/DOWN (^/∨)	CHANNEL LEVEL UP/DOWN (^/∨)
④			INPUT SELECTOR	INPUT SELECTOR		INPUT SELECTOR	INPUT SELECTOR
⑤			MUTE	MUTE		MUTE	MUTE
⑥			VOLUME UP/DOWN (^/∨)	VOLUME UP/DOWN (^/∨)		VOLUME UP/DOWN (^/∨)	VOLUME UP/DOWN (^/∨)
⑦					AUDIO SELECTOR		
⑧					SUBTITLE		
⑨					ZOOM		
⑩					SETUP		
⑪					MENU		
⑫					CURSOR CONTROL		
					ENTER		
⑬					DISPLAY		
⑭					RETURN		
⑮	PLAY	FORWARD PLAY		PLAY	PLAY		
⑯	PAUSE	REVERSE PLAY		PAUSE	PAUSE		
⑰	STOP	STOP		STOP	STOP		
⑱		RECORD		RECORD			
⑲		REWIND (◀◀) FAST FORWARD (▶▶)		REWIND (◀◀) FAST FORWARD (▶▶)	REVERSE SEARCH (◀◀◀) FORWARD SEARCH (▶▶▶)		
⑳	REVERSE SKIP (◀◀◀) FORWARD SKIP (▶▶▶)				REVERSE SKIP (◀◀◀) FORWARD SKIP (▶▶▶)		
㉑	NUMERIC		NUMERIC	NUMERIC	NUMERIC	NUMERIC	NUMERIC

Notes:

- Some functions for each component may not be available or may work differently.
- Depending on other kinds of components that are available for each DEVICE button, some functions may not be available or may work differently, too.
- For details about functions, refer to the operating instructions of each component.

OPERATING COMPONENTS WITH REMOTE CONTROL

- 1 Enter the setup code for each component other than this receiver you wish to control. For details, refer to "Entering a setup code" on page 13.
- 2 Turn on the component you want to operate.
- 3 Press the DEVICE button on the remote control corresponding to the component you wish to operate.
- 4 Aim the remote control at the REMOTE SENSOR of the component you wish to control and press the button corresponding to the operation you want.

REMOTE CONTROL OPERATION RANGE

- Use the remote control unit within a range of about 7 meters (23 feet) and angles of up to 30 degrees aiming at the remote sensor.

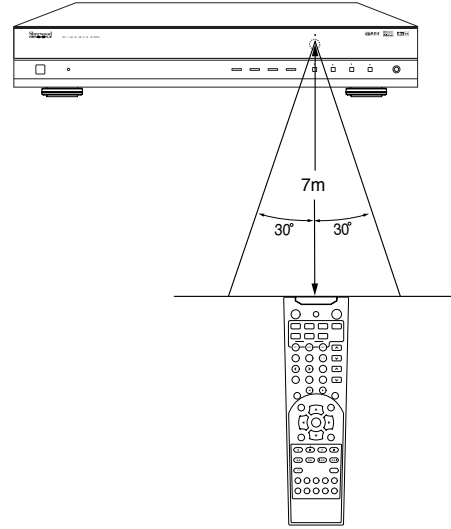

LOADING BATTERIES

- When the remote control does not operate, the old batteries should be replaced. In this case, load new batteries within several minutes after removing old batteries.
- If the batteries are removed or have been exhausted for a longer period of time, memorized contents will be cleared. Should this happen, you should memorize them again.

- 1 Remove the cover.

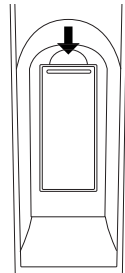

- 2 Load two batteries matching the polarity.

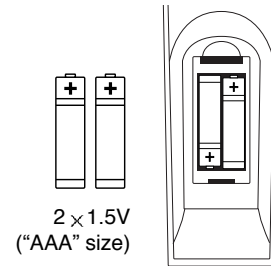

- Remove the batteries when they are not used for a long time.
- Do not use the rechargeable batteries (Ni-Cd type).
- Be sure to use alkaline batteries.

USING FUNCTIONS OF REMOTE CONTROL

- This remote control can control up to 8 different components.
- Before operating audio and video components other than this receiver with using this remote control, the setup code for each component should be entered.
- For system remote control operation, "000" was stored previously in the memory of the device button "CD" for Sherwood CD player, "DVD" for Sherwood DVD player and "AUX" for Sherwood tape deck respectively as its factory setup code. So, you don't need to enter its code for each Sherwood component except in such a case that its code does not work.

Entering a setup code

1 Turn on the component you want to control

2 Find the setup codes according to the type and the brand name of your component, referring to "SETUP CODE TABLE" on page 45.

3 Press and hold down both the ENTER button and the DEVICE button you want for more than 1 second.

4 Enter a 3 digit code, aiming the remote control at the remote sensor on the component. Example) When entering "001".

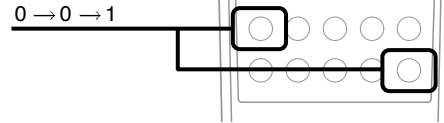
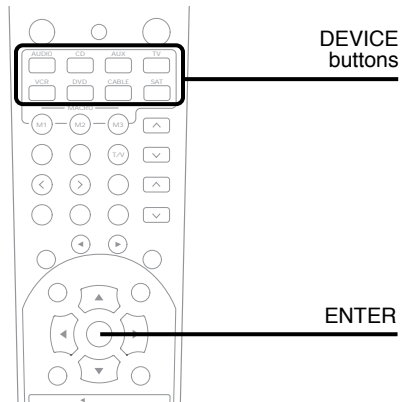

- The LED will flicker once.

Note:

- The AUDIO button is unavailable for the audio components other than this receiver.

- If entering is performed successfully, the LED will flicker twice.
- To be sure that the setup code is correct, press the POWER(or STANDBY) button. If your component is tuned off, the setup code is correct.
- When your component is not turned off, repeat the above steps 2 to 4, trying each code for your component until you find one that works.

Notes:

- If the LED did not flicker twice, then repeat the above steps 3 to 4 and try entering the same code again.
- Manufacturers may use different setup codes for the same product category. For that reason, it is important that you check to see if the code you have entered operates as many controls as possible. If only a few functions operate, check to see if another code will work with more buttons.

5 Repeat the above steps 1 to 4 for each of your components.

Using a punch-through function

This remote control may be programmed to operate either the AUDIO volume punch-through or the TV volume and/or TV channel punch-through in conjunction with any of the eight components controlled by this remote control.

For example, since this receiver will likely be used as the sound system while watching TV, you may want to adjust this receiver's volume although this remote control is set to control the TV.

- When programming this remote control for the AUDIO volume punch-through, press and hold down both "AUDIO" button and "VOLUME ^" button for more than 1 second.

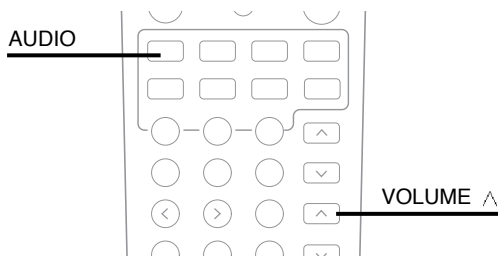

- If programming is performed successfully, the LED will flicker twice.
- When you want either TV volume or TV channel punch-through, press and hold down both "TV" button and either "VOLUME ^" or "CH ^" button for more than 1 second.

Note :

- If you use one of AUDIO and TV volume punch-through functions, you cannot use the other.

■ Removing a punch-through function

- When removing the AUDIO volume punch-through, press and hold down both "AUDIO" button and "VOLUME v" button for more than 1 second.

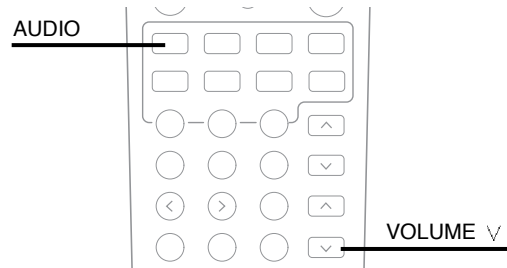

- If removing is performed successfully, the LED will flicker twice.
- When you want to remove either TV volume or TV channel punch-through, press and hold down both "TV" button and either "VOLUME v" or "CH v" button for more than 1 second.

■ Removing all punch-through functions

Press and hold down both "AUDIO" button and "AUTO" button for more than 1 second.

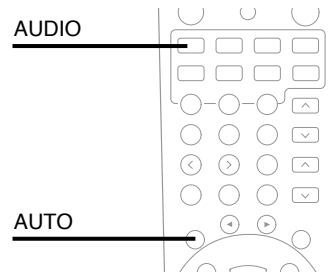

- If removing all punch-through functions is performed successfully, the LED will flicker twice.

Programming a macro function

- The macro function enables you to program a series of button operations (up to 10) on this remote control into a single button.
- You can store up to three separate macro command sequences into “M1”, “M2” and “M3” buttons.

1 Press and hold down both “ENTER” button and one of three NUMERIC buttons (“1”~“3”) corresponding to “M1”~“M3” buttons for more than 1 second.

Example) When programming a series of button operations into “M1” button.

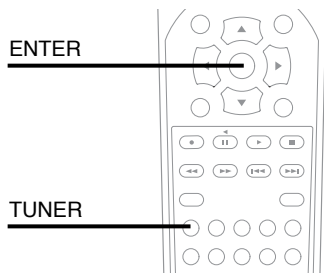

- If the macro mode is entered, the LED will flicker once.

2 Press the operation buttons you want to program in order.

Note:

You should press the corresponding DEVICE buttons before pressing each operation button.

Example) When playing a DVD on the DVD player connected to VIDEO 2 jacks of this receiver.

1. Press “AUDIO” button to control this receiver.
2. Press “POWER” button to turn this receiver on.
3. Press “AUDIO” button to control this receiver.
4. Press “VIDEO 2(7)” button to select the desired input source.
5. Press “DVD” button to control the DVD player.
6. Press “POWER” button to turn the DVD player on.
7. Press “DVD” button to control the DVD player.
8. Press “▶” button to start playback.

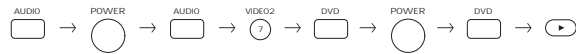

3 Press “ENTER” button.

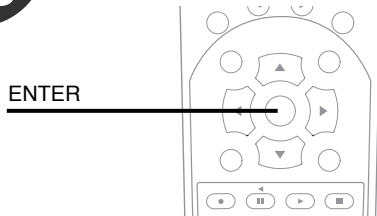

- If the programming is performed successfully, the LED will flicker twice.

To remove a macro program

- When removing a macro program, perform the above steps 1 and 3, but ignore the step 2.

To change a macro program

- When a new macro program is stored into a MACRO button with performing the above steps 1 to 3, the previous macro program is cleared from the memory of the MACRO button.

Operating a macro function

- Aim the remote control at the REMOTE SENSORS of the components to be controlled and press the MACRO button you want.
- Example) When pressing “M1” button.

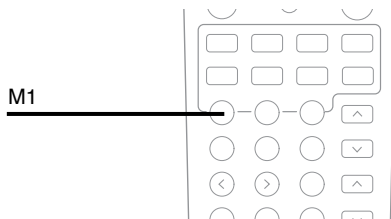

Notes:

- The codes programmed into a MACRO button will be transmitted at an interval of 0.5 seconds. However, some components may not be able to complete one operation in 0.5 seconds and may miss the next code. In this case, the macro function cannot control the corresponding components correctly.
- Be sure to use the remote control within the remote control operation range of the components.
- Depending on the operation status of the components, etc., the macro function cannot control the corresponding components correctly.

Before Operation

SURROUND SOUND

- This receiver incorporates a sophisticated Digital Signal Processor that allows you to create optimum sound quality and sound atmosphere in your personal Home Theater.

Surround modes

■ DTS Digital Surround

DTS Digital Surround(also called simply DTS) is a multi-channel digital signal format which can handle higher data rates than Dolby Digital. Although both Dolby Digital and DTS are 5.1 channel formats, discs bearing the “”

are generally thought to provide better sound quality due to the lower audio compression required.

It also provides wide dynamic range and separation, resulting in magnificent sound.

■ DTS - ES Extended Surround™

This is a new multi channel digital signal format which greatly improves the 360- degree surround impression and space expression thanks to further expanded surround signals, offering high compatibility with the conventional DTS format.

In addition to the 5.1 channels, DTS-ES Extended Surround also offers the surround back (sometimes also referred to as “surround center”) channel for surround playback with a total of 6.1 channels. DTS-ES Extended Surround includes two signal formats with different surround signal recording methods as follows:

• DTS-ES™ Discrete 6.1

Because the signals for 6.1 channels (including the surround back channel) are fully independent, it is possible to achieve a sense that the acoustic image are moving about freely among the background sounds surrounding the listener from 360 degrees.

Though maximum performance is achieved when sound tracks recorded with this system are played using a DTS -ES decoder, when played with a conventional DTS decoder, the surround back channel signals are automatically downmixed to the surround left and surround right channels so that none of the signal components are lost.

• DTS - ES™ Matrix 6.1

With this format, the additional surround back channel signals undergo matrix encoding and are input to the surround left and surround right channels beforehand. During playback, they are decoded to the surround left, surround right and surround back channels.

Because the bit stream format is 100% compatible with conventional DTS signals, the effect of the DTS-ES Matrix 6.1 format can be achieved even with DTS 5.1- channel signal sources. Of course, it is possible to play DTS-ES Matrix 6.1 - channel signal sources with a DTS 5.1 - channel decoder.

When DTS-ES Discrete 6.1 or Matrix 6.1 sources are decoded with a DTS - ES decoder, the format is automatically detected upon decoding and the optimum surround mode is selected. However, some DTS - ES Matrix 6.1 sources may be detected as DTS sources. In this case, the DTS - ES Matrix mode should be selected manually to play these sources.

■ DTS Neo : 6™ surround

This mode applies conventional 2-channel signals such as digital PCM or analog stereo signals to the high precision digital matrix decoder used for DTS-ES Matrix 6.1 to achieve 6.1-channel surround playback. DTS Neo : 6 surround includes two modes for selecting the optimum decoding for the signal source.

• DTS Neo : 6 Cinema

This mode is optimum for playing movies. Decoding is performed with emphasis on separation performance to achieve the same atmosphere with 2-channel sources as with 6.1-channel sources.

• DTS Neo : 6 Music

This mode is suited mainly for playing music. The front left and front right signals bypass the decoder and are played directly so there is no loss of sound quality, and the effect of the surround signals from the center, surround left, surround right and surround back channels adds a natural sense of expansion to the sound field.

“DTS”, “DTS-ES Extended Surround” and “Neo : 6” are trademarks of Digital Theater Systems, Inc.

■ Dolby Digital

Dolby Digital is the multi- channel digital signal format developed by Dolby Laboratories. Discs bearing the “” includes the recording of up to 5.1 channels of digital signals, which can reproduce much better sound quality, spatial expansion and dynamic range characteristics than the previous Dolby Surround effect.

■ Dolby Digital EX

This mode creates the back (sometimes also referred to as “surround center”) signals from the surround left and right signals in Dolby Digital 5.1 channel source using a matrix decoder and provides 6.1 channel surround playback. For the best results, this mode should be selected during playback of sources(bearing the “”) recorded in Dolby Digital Surround EX. With this additional channel, you can experience more dynamic and realistic moving sound especially.

When Dolby Digital EX sources are decoded with a Dolby Digital EX decoder, the format is automatically detected upon decoding and the Dolby Digital EX mode is selected. However, some Dolby Digital EX sources may be detected as Dolby Digital sources. In this case, the Dolby Digital EX mode should be selected manually to play these sources.

■ **Dolby Pro Logic**

Dolby Pro Logic is a specially encoded two channel surround format which consists of four channels (front left, center, front right and surround). Sources bearing the “” provide the theater-like surround sound.

The surround channel is monaural, but is played through both surround speakers.

■ **Dolby Pro Logic II surround**

This mode applies conventional 2- channel signals such as digital PCM or analog stereo signals as well as Dolby Surround signals, etc. to surround processing to offer improvements over conventional Dolby Pro Logic circuits. Dolby Pro Logic II surround includes two modes as follows:

• **Dolby Pro Logic II Cinema**

When enjoying movies, this mode allows you to further enhance the cinematic quality by adding processing that emphasizes the sounds of the action special effects.

• **Dolby Pro Logic II Music**

When listening to music, this mode allows you to further enhance the sound quality by adding processing that emphasizes the musical effects.

■ **Dolby Virtual**

This mode employs sophisticated digital processing to create the illusion of “phantom” speakers, this mode allows you to experience surround sound effects from Dolby Digital, Dolby Surround or 2-channel (recorded in digital PCM or analog stereo) sources, through just a single pair of front speakers.

Manufactured under license from Dolby Laboratories. “Dolby”, “Pro Logic”, “Surround EX” and the double-D symbol are trademarks of Dolby Laboratories.

■ **MPEG Multichannel**

This mode is a surround system which faithfully reproduces the ambience and dynamics of movie soundtracks and music alike. Though the number of audio channels is 5.1 which is same as Dolby Digital, discs bearing the “” provides much better at locating individual sounds to the correct and stable position in the sound stage.

- When using the 7 CH DIRECT INPUTs to playback the sound from an additional multichannel decoder for surround sound, you can enjoy the corresponding surround sound, too. For details, refer to the operating instructions of the component to be connected.

- The following modes apply conventional 2-channel signals such as digital PCM or analog stereo signals to high performance Digital Signal Processor to recreate sound fields artificially. Select one of the twelve provided surround modes according to the program source you want to play.

■ **Theater**

This mode provides the effect of being in a theater -in-the round when watching a play.

■ **Movie**

This mode provides the effect of being in a movie theater when watching a movie.

■ **Hall 1/2**

This mode provides the ambience of a chamber hall for chamber music or an instrumental solo (Hall 1) or a concert hall for orchestral music or an opera (Hall 2).

■ **Stadium**

This mode provides the expansive sound field to achieve the true stadium effect when watching baseball or soccer games.

■ **Church**

This mode provides the ambience of a church for baroque, string orchestral or choral group music.

■ **Club 1/2**

This mode creates the sound field of a jazz club with a low ceiling and hard walls (Club 1) or a live house with a relatively spacious floor (Club 2).

■ **Arena 1/2**

This mode provides the feeling of a live concert in a medium - sized (Arena 1) or large (Arena 2) arena.

■ **Game**

Use this mode to enjoy video game sources.

■ **Matrix**

This mode reproduces a delayed signals from the surround channels to emphasize the sense of expansion for music sources.

For your reference, the sound from each channel can be reproduced according to the surround modes as follows:

Modes	Channels	FRONT L/R	CENTER	SURROUND L/R	SURROUND BACK	SUBWOOFER
DTS		○	○	○	—	○
DTS ES DISCRETE/MATRIX		○	○	○	○	○
DTS NEO MOVIE/MUSIC		○	○	○	○	○
DOLBY DIGITAL		○	○	○	—	○
DOLBY DIGITAL EX		○	○	○	○	○
DOLBY PRO LOGIC		○	○	○	—	○
DOLBY PRO LOGIC II MOVIE/MUSIC		○	○	○	—	○
DOLBY VIRTUAL		○	—	—	—	○
MPEG		○	○	○	—	○
MATRIX		○	○	○	—	○
Other Surround		○	○	○	—	○
STEREO		○	—	—	—	○
7 CH DIRECT		○	○	○	○	○

- Depending on the speaker settings and the number of the encoded channels, the sound from the corresponding channels cannot be reproduced.(For details, refer to “Adjusting the speaker settings” on page 19.)

Speaker placement

Ideal speaker placement varies depending on the size of your room and the wall coverings, etc. The typical example of speaker placement and recommendations are as follows :

■ Front left and right speakers and center speaker

- Place the front speakers with their front surfaces as flush with TV or monitor screen as possible.
- Place the center speaker between the front left and right speakers and no further from the listening position than the front speakers.
- Place each speaker so that sound is aimed at the location of the listener's ears when at the main listening position.

■ Surround left and right speakers

- Place the surround speakers approximately 1 meter (40 inches) above the ear level of a seated listener on the direct left and right of them or slightly behind.

■ Surround back speaker

- Place the surround back speaker at the rear center facing the front at a slightly higher position (0 to 10 inches) than the surround speakers.
- We recommend installing the surround back speaker at a slightly downward facing angle. This effectively prevents the surround back channel signals from reflecting off the TV or screen at the front center, resulting in interference and making the sense of movement from the front to the back less sharp.

■ Subwoofer

- The subwoofer reproduces powerful deep bass sounds. Place a subwoofer anywhere in the front as desired.

■ Notes :

- When using a conventional TV , to avoid interference with the TV picture, use only magnetically shielded front left and right and center speakers.
- To obtain the best surround effects, the speakers except the subwoofer should be full range speakers.

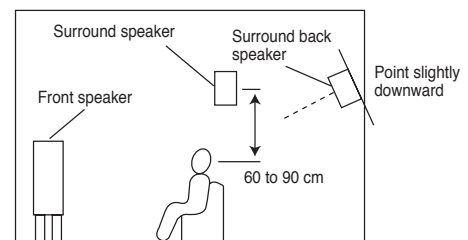
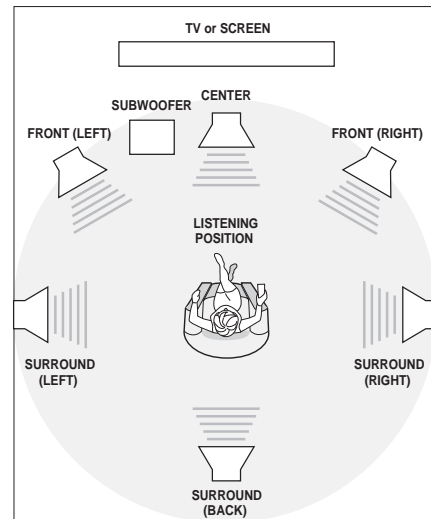

Adjusting the speaker settings

- After you have installed this unit and connected all the components, you should adjust the speaker settings for the optimum sound acoustics according to your environment and speaker layout.

Setting the type of speakers

The composition of the signals output from the different channels and the frequency response are adjusted automatically according to the combination of speakers actually being used.

- Select "Large" or "Small" not according to the actual size of the speaker but according to the speaker's capacity for playing low frequency (bass sound below frequency set for the Crossover Frequency mode and below) signals.

Large : Select this when connecting speakers that can fully reproduce sounds below crossover frequency(*) of your speaker.

Small : Select this when connecting speakers that cannot fully reproduce sound below crossover frequency. When this setting is selected, sound below crossover frequency is assigned to the subwoofer or speakers which are set to "Large"(when not using a subwoofer).

None : Select this when no speakers are connected. When this is selected, sound is sent to the front speakers.

Yes / None : Select the desired depending on whether a subwoofer is connected or not.

- (*) : **Crossover frequency** is the frequency (Hz) below which the bass sound of each main speakers is to output from the subwoofer or from speakers which are set to "Large" (when not using a subwoofer).
- Refer to the operating instructions of the speakers to be connected. If the frequency range of your speaker is 80 Hz ~ 12 KHz, the crossover frequency is 80 Hz.
- If you do not know, try comparing the sound at both settings (setting the volume to a level low enough so as not to damage the speakers) to determine the proper setting.

- Depending on relationship between speakers, settings possible for each speaker are as follows:

Front L/R	Center	Surr. L/R	Surr. Back	Subwoofer		
Large	Large	Large	Large	Yes or None		
			Small		Small	
			None		None	
	Small	Small	None		Large	
					Small	Small
					None	None
	None	None	None		Large	
					Small	Small
					None	None
	Small	Small	Small		Small	Yes
					None	
		None	Small		Small	
None				None		

Speaker distance settings

When enjoying 5.1 channel surround playback with Dolby Digital and DTS sources, it is ideal that the center and surround speakers should be the same distance from the main listening position as the front speakers. By entering the distance between the listening position and each speaker, the delay times of center and surround speakers are automatically adjusted to create an ideal listening environment virtually as if the center and surround speakers were at their ideal locations respectively as below:

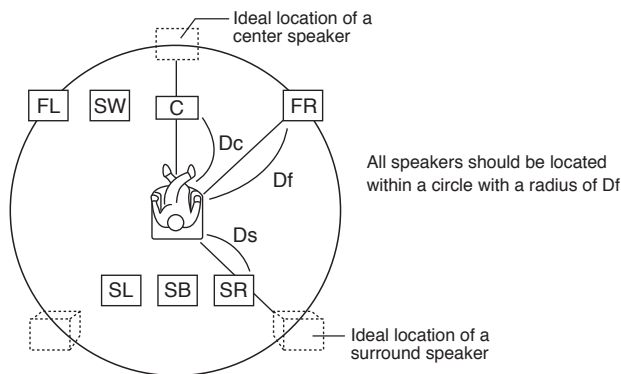

D_f : Distance between front speakers and listening position
 D_c : Distance between center speakers and listening position
 D_s : Distance between surround speakers and listening position

Refer to the previous page and adjust the speaker settings

• You can also adjust these settings with using the buttons on the front panel.(For details, refer to “SETTING UP THE SYSTEM ON FRONT PANEL” on page 43.)

Note : When the headphones are plugged or the 7 CH DIRECT is selected as an input source, the speaker setting function cannot be available.

1. When selecting each setting mode

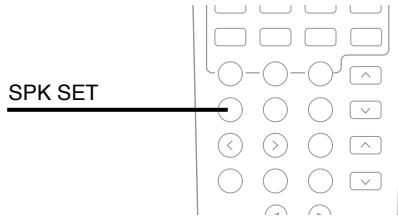

- Each time the SPEAKER SETUP button is pressed, the speaker setting mode changes in succession and is displayed for several seconds as follows.
- When the speaker setting mode disappears, press the SPEAKER SETUP button repeatedly to select the desired mode.

- When selecting the front-center-surround speaker setting mode,

“FL - CL - SL”

- When selecting the surround back speaker setting mode,

“SUR B - L”

- When selecting the subwoofer setting mode,

“SUB W - Y”

- Only when the surround back speaker is set to “N”, the subwoofer type mode can be selected.

“ACTIVE”

- When the surround back speaker does not exist, you can connect subwoofer into the terminal of surround back speaker. In this case, the setting of surround back speaker is N(one) and the type of subwoofer have to be changed to PASSIVE.

- When selecting the front left distance mode,

“FRONT L 3.0 (m)”

2. When adjusting the selected setting mode to the desired setting

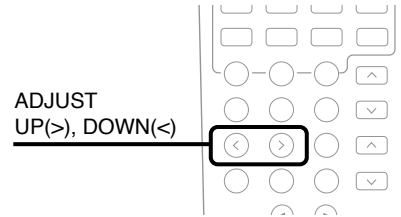

- Each time the ADJUST UP(>) or DOWN(<) button is pressed, one of the settings is selected and displayed for several seconds as follows.

- You can select one of 11 different speaker settings.
 FL - CL - SL / FL - CL - SN / FL - CS - SL /
 FL - CN - SL / FL - CS - SN / FL - CN - SS /
 FS - CS - SS / FS - CS - SN / FS - CN - SS /
 FL - CS - SS / FL - CL - SS
 (F: Front, C: Center, S: Surround, L: Large, S: Small, N: None)

→ L ↔ S ↔ N ←

- Depending on the surround speaker setting, you cannot select “L” or/and “S”.

Y(es) ↔ N(o)

- When the front speaker is set to “S”, the subwoofer is automatically set to “Y”.

ACTIVE ↔ PASSIVE

- When the surround back speaker is set to L(arge) or S(mall), this mode set to ACTIVE automatically and does not be displayed.

- You can adjust the distance within the range of 0.3 ~ 9.0 meters in 0.3 meter interval.

Note:

- When the type of speaker is set to “N”, its distance mode cannot be selected.

<ul style="list-style-type: none"> When selecting the front right distance mode, "FRONT R 3.0 (m)" 	<ul style="list-style-type: none"> You can adjust the distance within the range of 0.3 ~ 9.0 meters in 0.3 meter interval.
<ul style="list-style-type: none"> When selecting the center distance mode, "CENTER 3.0 (m)" 	
<ul style="list-style-type: none"> When selecting the surround left distance mode, "SURR L 3.0 (m)" 	
<ul style="list-style-type: none"> When selecting the surround right distance mode, "SURR R 3.0 (m)" 	
<ul style="list-style-type: none"> When selecting the Dolby Virtual delay time mode, "NARROW" 	<p>Note:</p> <ul style="list-style-type: none"> When the type of speaker is set to "N", its distance mode cannot be selected.
<ul style="list-style-type: none"> This mode can work only in the Dolby Virtual mode. In the other surround modes, this setting is just displayed. 	<p>NARROW : Relatively long distance for the main listening position to front speakers.</p> <p>↑ ↓</p> <p>WIDE : Relatively short distance.</p>
<ul style="list-style-type: none"> When selecting the crossover frequency setting mode, "CFREQ 80" 	<p>80 ↔ 120 ↔ 160 ↔ 200 (unit : Hz)</p>

Operations

- Note : Before operating this receiver with the supplied remote control, refer to "Universal Remote Controls" on page 10 for details about operation.

■ Memory backup function

- These following items, set before the receiver is turned off, are memorized:
Input settings, surround mode settings, speaker settings, channel level settings, preset stations, etc.

TURNING THE POWER ON/OFF

1 Press the POWER switch.



- This unit enters the standby mode. The lighting of STANDBY indicator means that the receiver is not disconnected from the AC mains and a small amount of current is retained to support the memorized contents and operation readiness.
- To switch the power off, push the POWER switch again. Then the power is cut off and the STANDBY indicator goes off.

2 In the standby mode, turn the power on.

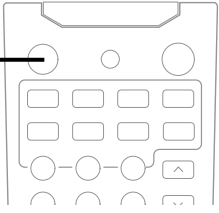

- Each time the POWER button on the remote control is pressed, the receiver is turned on to enter the operating mode or off to enter the standby mode.
- In the standby mode, if the INPUT SELECTOR button is pressed, the receiver is turned on automatically and the desired input is selected.

※ When the power operation switch is in the OFF or STANDBY state, the apparatus is still connected on some AC line voltages.
Please be sure to unplug the cord when you leave home for, say, a vacation.

LISTENING TO A PROGRAM SOURCE

1

Select the desired input source.

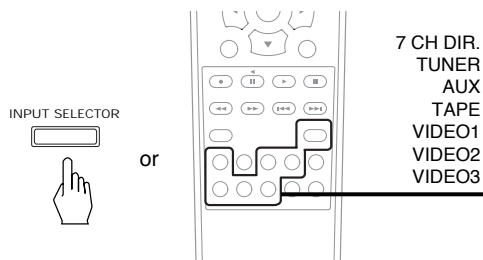

- Each time the INPUT SELECTOR button on the front panel is pressed, the input source changes as follows;

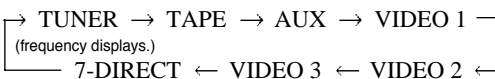

■When selecting the 7 CH DIRECT

- “7-DIRECT” is displayed and the 7 or 6 separate analog signals from the component connected to this input can be controlled only by volume depending on the surround back speaker setting.
- These analog signals (except front L/R channel) cannot be recorded.

When AUX, VIDEO 1~3 is selected as an input source

2

Select the digital or analog input connected as desired.

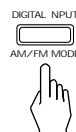

- Each time this button is pressed, the corresponding input is selected as follows ;

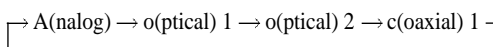

- To listen to a DTS, Dolby Digital or MPEG program source in the 2-CH downmix mode, in the stereo mode, the corresponding digital input should be selected. (For details, refer to “Downmixing into 2 front channels” on page 30.)

■Notes :

- When the selected optical or coaxial digital input is not connected, the “DIGITAL” indicator flickers, meaning no sound.
- The sound from the component connected to the selected digital input can be heard regardless of the selected input source.

3

Depending on the input digital signal format, select the desired decoding mode.

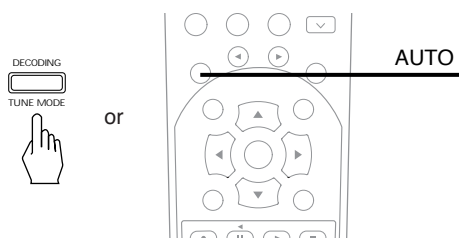

- Each time this button is pressed, the decoding mode changes as follows :

IN-AUTO : The input digital signal format(DTS, Dolby Digital, MPEG or PCM(2 channel stereo), etc.) used by the selected digital input source is detected automatically to perform the necessary decoding process for optimum surround mode.

IN-DTS : The DTS signal processing is performed only when DTS signals are input.

IN-PCM : The PCM signal processing is performed only when PCM signals are input.

■Notes :

- Only when the digital input is selected as signal input for the input sources except TUNER, TAPE and 7 CH DIRECT, the decoding mode can be selected.
- Noise may be generated at the beginning of playback and while searching during DTS playback in the IN-AUTO mode. In this case, try playing in the IN-DTS mode.

4 Operate the selected component for playback.

- When playing back the program sources with surround sound, refer to “ENJOYING SURROUND SOUND” on page 24.

5 Adjust the (overall) volume.

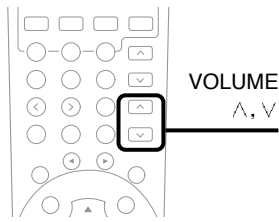

VOLUME
Δ, V

6 To mute the sound,

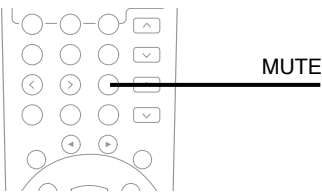

MUTE

- “MUTE” will flicker.
- To resume the previous sound level, press it again.

7 To listen with the headphones,



PHONES

- The sound from the speakers is cut off.
- When listening to a DTS, Dolby Digital or MPEG program source, if the headphones are plugged, it enters the 2-CH downmix mode automatically. (For details, refer to “Downmixing into 2 front channels” on page 30.)

ENJOYING SURROUND SOUND

- When the AUTO OSD function is on, the corresponding setup display is on the TV screen.

Selecting the surround mode

- You can also select the surround mode with using the buttons on the front panel.
(For details, refer to “SETTING UP THE SYSTEM ON FRONT PANEL” on page 44.)

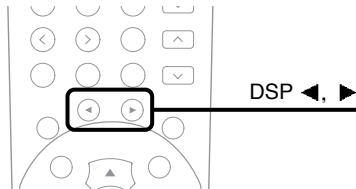

- Each time the DSP MODE ◀ or ▶ button is pressed, the surround mode changes depending on the signal format being input and the selected decoding mode as follows :

Signal format being input	Selected decoding mode	Selectable surround mode
Dolby Digital 5.1, Dolby Digital EX 6.1 channel sources	IN-AUTO mode	(DOLBY DIGITAL EX,) DOLBY DIGITAL, DOLBY VIRTUAL
Dolby Digital 2-channel sources	IN-AUTO mode	(DOLBY DIGITAL EX,) PL II CINEMA, PL II MUSIC, PRO LOGIC, DOLBY VIRTUAL
PCM(2 channel) sources Analog stereo sources	IN-AUTO, IN-PCM mode	PL II CINEMA, PL II MUSIC, PRO LOGIC, DOLBY VIRTUAL, NEO 6 CINEMA, NEO 6 MUSIC, THEATER, MOVIE, HALL 1/2, STADIUM, CHURCH, CLUB 1/2, ARENA 1/2, GAME, MATRIX
DTS 5.1, DTS ES Discrete 6.1, DTS ES Matrix 6.1 sources	IN-AUTO, IN-DTS mode	(DTS ES DISCRETE/MATRIX) DTS
MPEG sources	IN-AUTO mode	corresponding MPEG surround mode

(): possible only when surround back speaker setting is not “N”.

- When 96 kHz PCM signals are input, the stereo mode is selected automatically; the surround mode cannot be selected.
- When MPEG signals are input in the IN-AUTO mode, the corresponding MPEG surround mode will be selected regardless of using the DSP MODE ◀ or ▶ button.

■ Notes:

- When the selected decoding mode is not matched to the input signal format, the “DIGITAL” indicator flickers and no sound is heard. Therefore, be sure to select the required decoding mode and the available surround mode according to the input signal format.
- When the 7 CH DIRECT is selected as an input source, the decoding and surround modes cannot be selected.
- When the digital signals are not input, the desired surround mode cannot be selected.
- When the headphone is used, the surround mode cannot be selected.

■ To cancel the surround mode for stereo operation

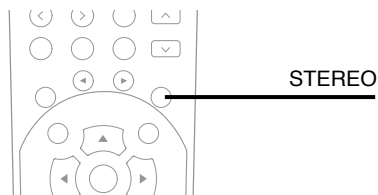

- Then the stereo mode is selected.
- To cancel the stereo mode, select the desired surround mode with using the DSP MODE ◀ or ▶ button.

Adjusting each channel level with test tone

- You can adjust the level of test tone for each channel so that they are all heard at the same level.
- Note : When the 7 CH DIRECT is selected as an input source or the headphones are plugged, the test tone function does not work.

1 Enter the test tone mode.

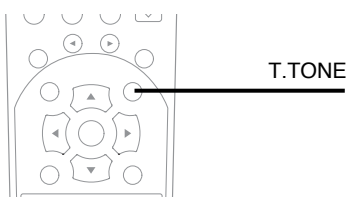

T.TONE

- The test tone will be heard from the speaker of each channel for 2 seconds as follows:

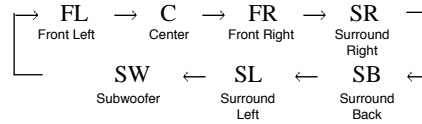

- When the speaker setting is “N”, the test tone of the corresponding channel is not available.

2 At each channel, adjust the level so that they are all heard at the same level.

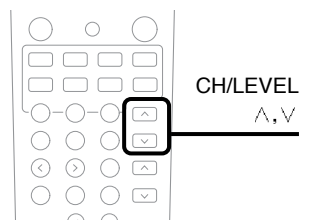

CH/LEVEL
▲,▼

- You can select the desired channel and adjust its level with repeating the steps 1 and 2 in “Adjusting each channel level” procedure.

3 Cancel the test tone function.

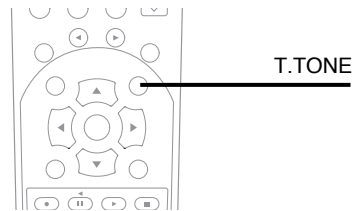

T.TONE

Adjusting each channel level

- After adjusting each channel level with test tone, adjust the channel levels either according to the program sources or to suit your tastes.
- You can also adjust the channel levels with using the buttons on the front panel.
(For details, refer to “SETTING UP THE SYSTEM ON FRONT PANEL” on page 43.)

1 Select the desired channel.

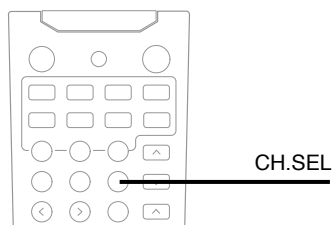

CH.SEL

- Each time this button is pressed, the corresponding channel is selected and displayed for several seconds as follows:

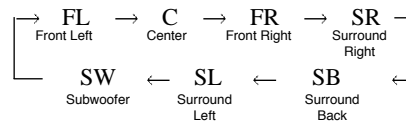

- When it is in the stereo or Dolby Virtual mode or the speaker setting is “N”, center, surround L/R, surround back or subwoofer channel will not be selected.
- When the headphones are plugged, only the front L/R channel can be selected.

2 Adjust the level of the selected channel as desired.

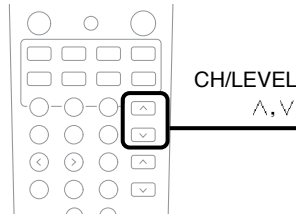

3 Repeat the above steps 1 and 2 to adjust each channel level.

- If the channel display disappears, start from the step 1 again.

Presetting and Calling the channel levels

- You can store the adjusted channel levels in the memory. If you change the channel levels and want to hear with preset levels, you can call them again.

■ Presetting the channel levels

1 Perform the steps 1 to 3 in “Adjusting each channel level” on page 25~26 to adjust each channel level you want.

2 Press the SETUP button for more than 2 seconds, then it enters the setup mode. While displaying the setup mode, press this button short repeatedly until “P CALL” is displayed.



3 While displaying “P CALL”, select “P MEMORY” with buttons below.

4 Confirm your decision.

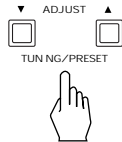

- “P CALL” : When calling the preset channel levels.
- “P MEMORY” : When storing the adjusted channel levels in the preset memory.

- The adjusted channel levels has now been stored in the preset memory.
- When using this function with remote control unit, press OSD button and refer to page 38~40.

■ Calling the channel levels

- Select “P CALL” with performing the above steps 2 to 4.
- Then the current channel levels are changed to the preset ones.

Adjusting the LFE level

- You can adjust the LFE(Low Frequency Effect) levels included in Dolby Digital, DTS and MPEG program sources.

1 Press the SETUP button for more than 2 seconds, then it enters the setup mode. While displaying the setup mode, press this button short repeatedly until “DD L” is displayed.



2 While displaying “DD L”, each time the button below is pressed, the mode changes as follows:

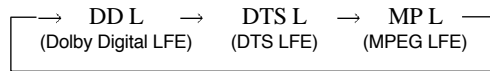

3 While displaying the desired LFE mode, adjust the level as desired.

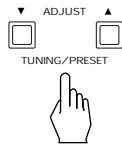

- The Dolby Digital LFE level can be adjusted within the range of -10~0 dB and other LFE levels within the range of -10~+10 dB.
- In general, we recommend the LFE level to be adjusted to 0 dB.(However, the recommended LFE level for some early DTS software is -10 dB.) If the recommended levels seem too high, lower the setting as necessary.
- When using this function with remote control unit, press OSD button and refer to page 38~40.

- The LFE level can be adjusted and applied when Dolby Digital, DTS or MPEG program source is inputted. In case of other program sources, this mode is adjustable, but not applied.

Adjusting the tone(bass and treble)

1 Press the SETUP button for more than 2 seconds, then it enters the setup mode. While displaying the setup mode, press this button short repeatedly until “TONE OFF” or “BASS” is displayed.



2 While displaying “BASS”, each time the DECODING button is pressed, the tone mode changes as follows:

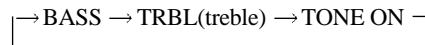

- While displaying “TONE OFF”, you cannot adjust the tone. To adjust the tone, first perform the step 3 and change “TONE OFF” to “TONE ON”.

3

While displaying the desired tone mode, adjust the tone as desired.

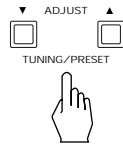

- Each adjustable range of bass and treble is -10~+10.
- In general, we recommend the bass and the treble to be set to 0(flat) level.
- At “TONE ON” mode, you can select “TONE OFF” mode and vice versa.

TONE ON: When adjusting the tone for your taste.

↕ (“DIRECT” indicator goes off.)

TONE OFF: When listening to a program source without the tone effect.

↕ (“DIRECT” indicator light up.)

- When using this function with remote control unit, press OSD button and refer to page 38~40.

■ Notes:

- If the display of the corresponding mode disappears, start from the step 1 again.
- Extreme settings at high volume may damage your speakers.
- When the digital signals from DTS, Dolby Digital or MPEG program sources are input in available surround mode, you cannot adjust the tone and can hear a program source without the tone effect.

Compressing the dynamic range (Dolby Digital sources only)

- This function compresses the dynamic range of previously specified parts of the Dolby Digital sound track(with extremely high volume) to minimize the difference in volume between the specified and non-specified parts. This makes it easy to hear all of the sound track when watching movies at night at low levels.
- Only when the digital signals from Dolby Digital program source are input in available surround mode, the dynamic range can be adjusted.

1

Press the SETUP button for more than 2 seconds, then it enters the setup mode. While displaying the setup mode, press this button short repeatedly until “DYNR 0.0” is displayed.



2

While displaying “DYNR 0.0”, select the desired mode.

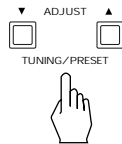

- Each time the ADJUST UP(▲) or DOWN(▼) button is pressed, the mode changes as follows:

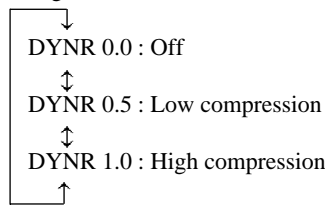

- When using this function with remote control unit, press OSD button and refer to page 38~40.

■ Notes:

- If the display of the dynamic range mode disappears, start from the step 1 again.
- In some Dolby Digital softwares, this function may not be available.

Adjusting the Dolby Pro Logic II Music parameters

- When selecting the Dolby Pro Logic II Music mode, you can adjust the various surround parameters for optimum surround effect.
- You can also adjust the Dolby Pro Logic II Music parameters with using the buttons on the front panel. (For details, refer to “SETTING UP THE SYSTEM ON FRONT PANEL” on page 43.)

1 Press the PL II MUSIC PARAMETER button to select the desired parameter.

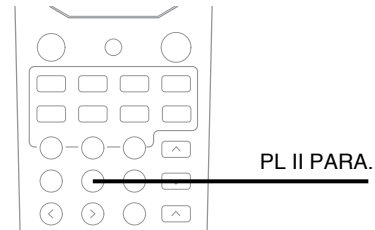

- Each time this button is pressed, the parameter changes and is displayed for several seconds as follows;
 - ※**Panorama mode (“PANO”, default value: OFF)**
This mode extends the front stereo image to include the surround speakers for an exciting “wraparound” effect with side wall imaging. Select “OFF” or “ON”.
 - ※**Center width control (“C-WID”, default value: 0)**
This adjusts the center image so it may be heard only from the center speaker, only from the left/right speakers as a phantom image, or from all three front speakers to varying degrees. The control can be set in 8 steps from 0 to 7.
 - ※**Dimension control (“DIMEN”, default value: 0)**
This gradually adjusts the soundfield either towards the front or towards the rear. The control can be set in 7 steps from -4 to +2.

2 While displaying the desired parameter, adjust it as desired.

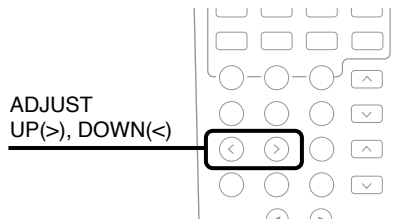

- If the parameter display disappears, start from the step 1 again.

3 Repeat the above steps 1 and 2 to adjust other parameters.

Downmixing into 2 front channels

- Allows the multi - channel DTS, Dolby Digital or MPEG signal to be reproduced through only two speakers or through headphones.
- When the digital signals from the DTS, Dolby Digital or MPEG program sources are input in available surround mode, press the STEREO button.

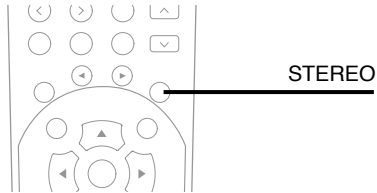

- “ST” indicator lights up and “2 CH DOWNMIX” is scrolled, meaning it enters the 2-CH downmix mode, and then the discrete multi-channels(except LFE) are mixed down into 2 front channels.

- To cancel the 2 - CH downmix mode, select the desired surround mode with the DSP MODE DOWN (◀) or UP(▶) button.
- When the playback of the source on the player is stopped, interrupted, etc., the 2 - CH downmix mode is not canceled even though “ ST” and the DTS or Dolby Digital indicators go off.
- If the headphones are plugged while the digital signals from the DTS, Dolby Digital or MPEG program sources are being input, it will enter the 2-CH downmix mode automatically and if the headphones are unplugged in the 2-CH downmix mode, it will return to the previous mode.

LISTENING TO RADIO BROADCASTS

■ To select the tuner,

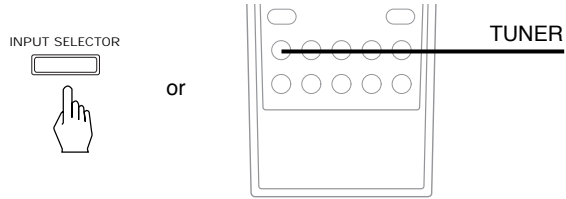

■ To select the desired band

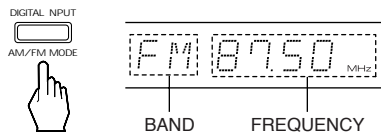

- Each time this button is pressed, the band is changed as follows:

→ FM STEREO → FM MONO → AM

- When FM stereo broadcasts are poor because of weak broadcast signals, select the FM mono mode to reduce the noise, the FM broadcasts are reduced in monaural sound.

Manual tuning

※ Manual tuning is useful when you already know the frequency of the desired station.

- 1 Select the tuning mode.

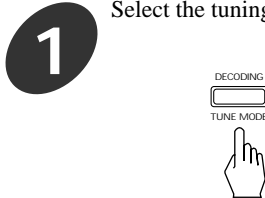

- Each time this button is pressed, the mode changes as follows;

↳ Tuning mode : “PRESET” goes off. ↳
 ↳ Preset mode : “PRESET” lights up. ↳

- 2 Press the below button repeatedly until the right frequency has been reached.

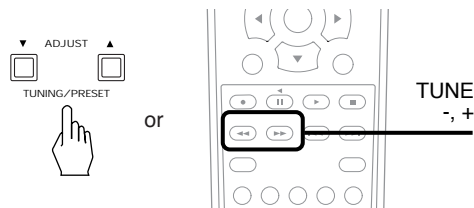

Auto tuning

- 1 Select the tuning mode.

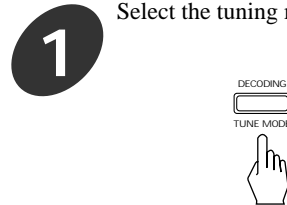

- 2 Press the below button for more than 0.5 second.

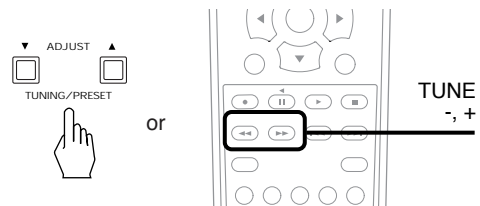

- The tuner will now search until a station of sufficient strength has been found. The display shows the tuned frequency and “TUNED”.
- If the station found is not the desired one, simply repeat this operation.
- Weak stations are skipped during auto tuning.
- When pressing the TUNE +/- buttons on the remote control, you need not select the tuning mode on step 1.

Presetting radio stations

- You can store up to 30 preferred stations in the memory.

1

Tune in the desired station with auto or manual tuning.

2

Press the MEMORY button.



- “MEM” is flickering for 5 seconds.

3

Select the desired preset number (1~30) and press the MEMORY button.

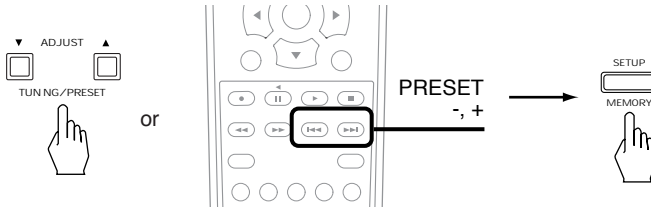

- The station has now been stored in the memory.
- A stored frequency is erased from the memory by storing another frequency in its place.
- If “MEM” goes off, start again from the above step 2.

4

Repeat the above steps 1 to 3 to memorize other stations.

Tuning to preset stations

1

After selecting the tuner as an input source, select the preset mode.

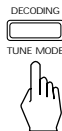

- Then “PRESET” lights up.

2

Select the desired preset number.

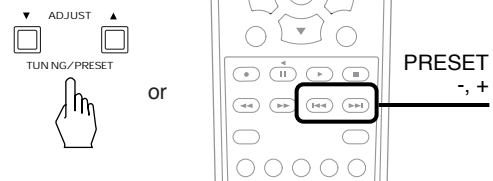

- When pressing the PRESET +/- buttons on the remote control, you need not select the preset mode on step 1.

Scanning preset stations in sequence

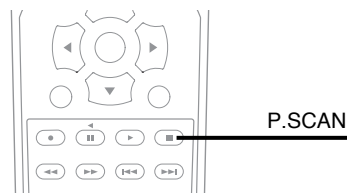

- The receiver will start scanning the stations in the preset sequence and each station is received for 5 seconds.
- At the desired station, press this button again to stop scanning.
- When pressing this button without selecting the tuner, the tuner will be selected automatically.

LISTENING TO RDS BROADCASTS(FM ONLY)

※THIS IS ADDITIONAL FUNCTION FOR R-903R TUNER ONLY

RDS(Radio Data System) is a method for sending information signals together with the transmitter signals. Your tuner is capable of translating these signals and putting the information on the display. These codes contain the following informations. Program Service name(PS), A list of Program Types(PHY), Traffic Announcement(TA), Clock Time(CT), Radio Text(RT).

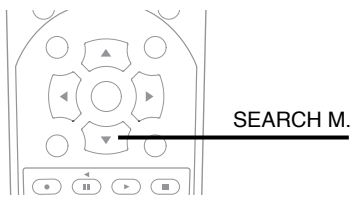
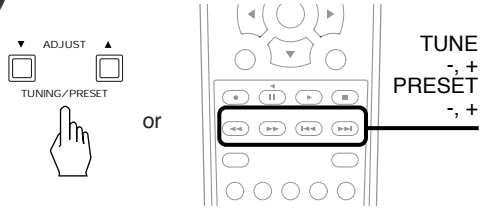
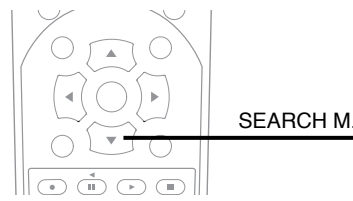
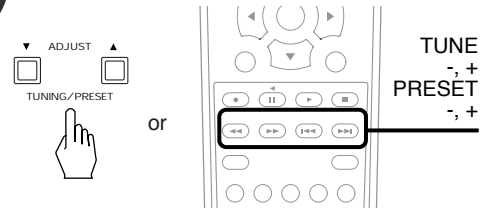
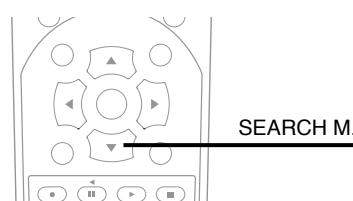
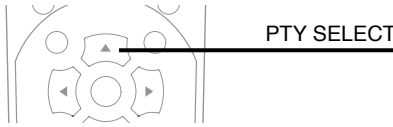
<p>RDS search</p> <ul style="list-style-type: none"> Use this function to automatically search and receive the stations offering RDS services. <p>1 In the FM mode, select the RDS search mode.</p>  <p>SEARCH M.</p> <ul style="list-style-type: none"> Each time this button is pressed, the search mode changes as follows; RDS SRCH → TP SRCH → PHY SRCH → OFF 	<p>2 While displaying “RDS SRCH”,</p>  <ul style="list-style-type: none"> The tuner automatically searches stations offering RDS services and the station name is displayed. If the station found is not the desired one, press the ADJUST/TUNE/PRESET UP(>/▲/+) or DOWN(</▼/−) button again while the RDS indicator is flickering. If no other RDS station is found, “NO RDS” is displayed. When “RDS SRCH” is not displayed, repeat again from the above step 1.
<p>TP search</p> <ul style="list-style-type: none"> Use this function to automatically search and receive the stations broadcasting the traffic program. <p>1 In the FM mode, select the TP search mode.</p>  <p>SEARCH M.</p> <ul style="list-style-type: none"> “TP SRCH” is displayed. 	<p>2 While displaying “TP SRCH”.</p>  <ul style="list-style-type: none"> The tuner automatically searches for stations broadcasting the traffic program. “NO TRAFF” is displayed if the signal is too weak or there are no stations broadcasting the traffic program. When “TP SRCH” is not displayed, repeat again from the above step 1.
<p>PTY search</p> <ul style="list-style-type: none"> Use this function to automatically search and receive the stations broadcasting the desired program type. <p>1 In the FM mode, select the PTY search mode.</p>  <p>SEARCH M.</p> <ul style="list-style-type: none"> “PTY SRCH” is displayed. 	<p>2 While displaying “PTY SRCH”, select the desired program type.</p>  <p>PTY SELECT</p> <ul style="list-style-type: none"> Each time this button is pressed, one of 32 different types of programs is selected. (NEWS, AFFAIRS, INFO, SPORT, EDUCATE, DRAMA, CULTURE, SCIENCE, VARIED, POP M, ROCK M, EASY M, LIGHT M, CLASSICS, OTHER M, WEATHER, F NANCE, CHILDREN, SOCIAL, RELIGION, PHONE IN, TRAVEL, LEISURE, JAZZ, COUNTRY, NATION M, OLDIES, FOLK M, DOCUMENT, TEST, ALARM, NONE) When “PTY SRCH” is not displayed, repeat again from the above step 1.

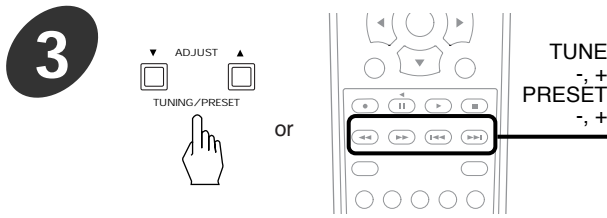

- The tuner automatically searches a station offering PTY services.
- If no station is found, "NO PROG" is displayed.

EON PTY (EON: Enhanced Other Networks information)

- Use this function to automatically search and receive the desired program type while listening to a RDS station.

1 In the RDS mode,

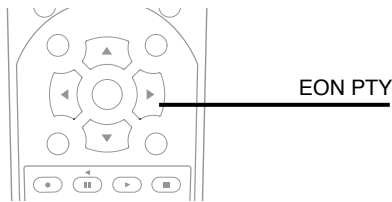

- Program type is displayed and the EON PTY indicator is flickering.

2 While the PTY indicator is flickering, select the desired program type.

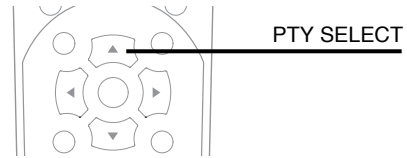

- If one of the preset stations is broadcasting the selected program type, it will be tuned in while listening to a RDS station.
- If the station stops broadcasting the selected program type, the tuner will find other stations repeatedly.
- If no station is found, the previous RDS station will be tuned in.
- When the PTY indicator goes off, repeat again from the above step 1.
- press the EON PTY button to cancel the EON PTY mode.

EON TA

- Use this function to automatically search and receive the traffic announcement while listening to traffic program.

In the TP mode,

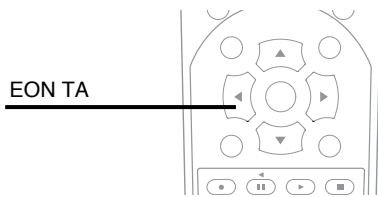

- Traffic program is displayed and the EON TA indicator lights up.
- If the preset station broadcasting traffic announcement is found, it will be tuned in while listening to the traffic program.
- If the station stops broadcasting traffic announcement, the tuner will find other stations repeatedly.
- If no station is found, the previous traffic program station will be tuned in.
- Press the EON TA button to cancel the EON TA mode.

DISPLAY

In the FM mode,

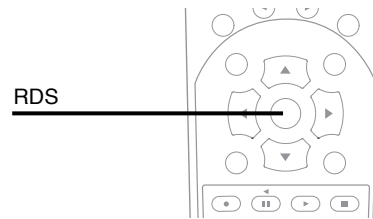

- Each time this button is pressed, the display mode changes as follows;

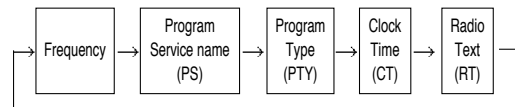

- If the signals are too weak or no RDS service is available, "NO NAME", "NO PTY", "NO TIME" or "NO TEXT" will be displayed.

ANALOG AUDIO/VIDEO RECORDING

- The analog signals (except front L/R channel) from the 7 CH DIRECT inputs as well as the digital signals from the coaxial or optical digital input cannot be recorded.
- The volume and tone (bass, treble) settings have no effect on the recording signals.

Recording with TAPE

- 1** Select the desired input as a recording source except for TAPE.

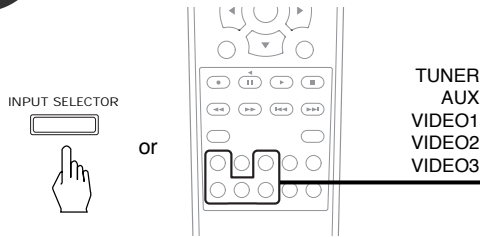

2

Start recording on the TAPE.

3

Start play on the desired input.

Dubbing from video components onto VIDEO 1

- 1** Select VIDEO 2 or VIDEO 3 as a recording source.

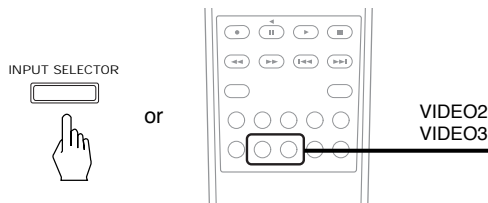

2

Start recording on the VIDEO 1.

3

Start play on the VIDEO 2 or the VIDEO 3.

- The audio and video signals from the VIDEO 2 or the VIDEO 3 will be dubbed onto the VIDEO 1 and you can enjoy them on the TV set and from the speakers.

Dubbing the audio and video signals separately onto VIDEO 1

Example) When dubbing the VIDEO 2 video signal and the CD audio signal separately onto VIDEO 1.

- 1** Select AUX as an audio recording source.
 ※ CD player should be connected to AUX jacks.

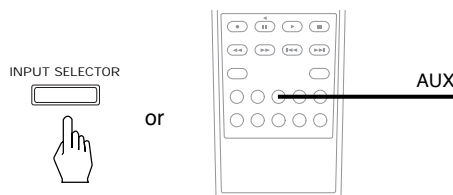

2

Press the OSD button on the remote control unit and select FUNCTION SELECT → VIDEO SELECT → VIDEO 2.
 (Refer to page 39.)

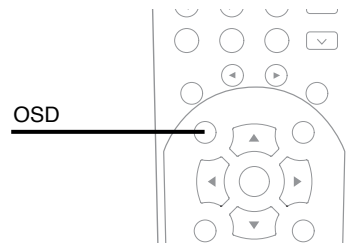

<p>3 Start recording on the VIDEO 1.</p>	<p>4 Start play on the AUX and the VIDEO 2 respectively.</p> <ul style="list-style-type: none"> • The audio signal from the AUX and the video signal from the VIDEO 2 will be dubbed and you can enjoy them on the TV set and from the speakers.
<p>※ If you select AUX for hearing and VIDEO 1 for seeing, whenever you select AUX, the VIDEO 1 is selected automatically as video input source. So you are sure to be observe the order and doing of the above steps 1 and 2.</p>	

DIGITAL AUDIO RECORDING WITH MD RECORDER

• Only when the OPTICAL DIGITAL OUT of this receiver is connected to the OPTICAL DIGITAL IN of the MD recorder or CD recorder, you can enjoy high-quality sound of digital recording without converting the original signals. Refer to “CONNECTING AUDIO COMPONENTS”/ “CONNECTING VIDEO COMPONENTS”/“CONNECTING DIGITAL INs and OUT” on page 6~7 and the operating instructions of the MD recorder or CD recorder.

■Notes:

- Digital recording is available for the digital audio program sources such as CDs, MDs, some DVDs, etc.
- In most DVDs as well as some CDs, etc., digital recording may not be available depending on the signal format.
- There are some restrictions on recording digital signals. When making digital recordings, refer to the operating instructions of your digital recording equipment to know what restrictions are imposed.

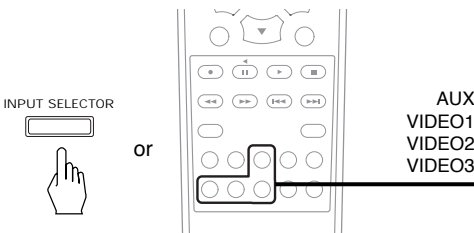
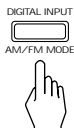
<p>1 Select a desired input of AUX, VIDEO 1~3 as a recording source.</p> 	<p>2 For digital recording, select the desired digital input as recording signal input.</p>  <ul style="list-style-type: none"> • Each time this button is pressed, the corresponding input is selected as follows: → A(nalog) → o(ptical) 1 → o(ptical) 2 → c(oaxial) 1 <p>■Note : When the selected digital input is not connected, “DIGITAL” indicator flickers. There will be no recording as well as no sound.</p>
<p>3 Start recording on the component connected to OPTICAL DIGITAL OUT.</p>	<p>4 Start play on the desired input.</p>

OTHER FUNCTIONS

Operating the sleep timer

- The sleep timer allows this unit to continue to operate for a specified period of time before automatically shutting off.
- To set the receiver to automatically turn off after the specified period of time.

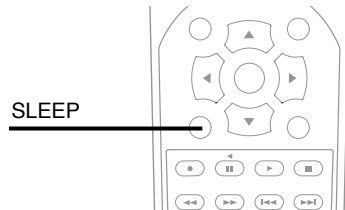

- Each time this button is pressed, the sleep time changes and "GOOD NIGHT" message scrolls.

→ 10 → 20 → 30 → 60 → 90 → OFF
Unit : minutes

- While operating the sleep timer, "SLEEP" lights up.

Adjusting the brightness of the fluorescent displays

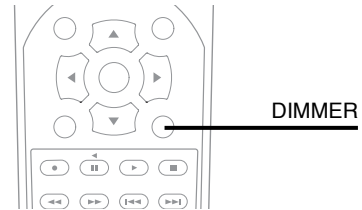

- Each time this button is pressed, the brightness of fluorescent display of this unit changes as follows;

→ ON → dimmer → OFF

- In the display OFF mode, pressing any button will restore the display ON mode.

Using the OSD

This unit incorporates an OSD(On-screen display) function to provide information about basic operation of this unit and to simplify the setup procedures.

The OSD function uses a monitor TV connected to this unit as a display and has two kinds of display modes such as current status display and menu screen.

■Notes:

- Any on-screen display shown on the monitor TV will not be recorded onto VIDEO 1.
- In some countries, this unit allows you to select either NTSC or PAL color system as video format.
If it is different from your video components and video softwares, etc., in the standby mode, press the ADJUST down(▼) button keeping the SETUP button pressed on the front panel, then the video format is changed to the NTSC or the PAL color system.

However, it is fixed to NTSC color system in other countries.

CURRENT STATUS DISPLAY

When the AUTO OSD mode is set to ON on the menu screen, this mode shows the status corresponding to each operation.

- The on-screen display will automatically disappear in several seconds.
- For examples, there are 2 status displays as follows.

■When selecting the desired input source

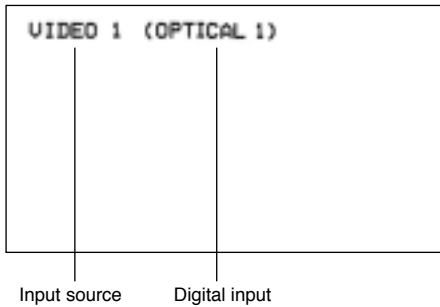

■When selecting the TEST TONE mode

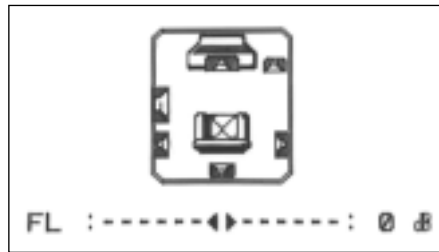

- When the speaker setting is "N", the test tone of the corresponding channel is not shown.
- When adjusting each channel level or overall volume, the volume level display will be shown.
- The test tone display will be shown until the test tone mode is canceled.

MENU SCREEN

- This function simplifies the setup procedures.
- The menu screen operation is performed easily with the CURSOR control(▲, ▼, ◀, ▶), OSD and ENTER buttons.

1 Turn the menu screen on.

MAIN MENU

▶SPEAKER SETUP
FUNCTION SELECT
SURROUND MODE
CH LEVEL SETUP
AUTO OSD :

OSD : QUIT ▲, ▼ : MOVE
ENTER : SELECT OR CHANGE

- The main menu will be shown.
- To turn the menu screen off, press this button again.

OSD : quit this OSD
 ▲, ▼ : press cursor up(▲)/ down(▼) button to move
 ENTER : select menu or change the setting

2 Select the desired menu using the CURSOR UP(▲) or DOWN(▼) button.

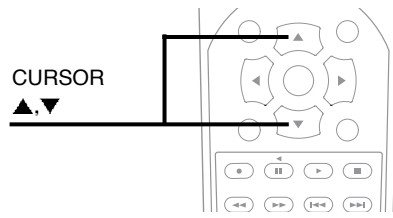

3 Confirm your selection.

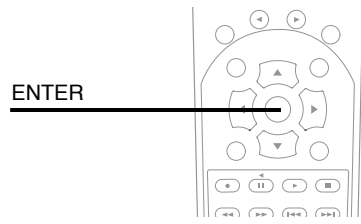

■ When selecting the **SPEAKER SETUP**

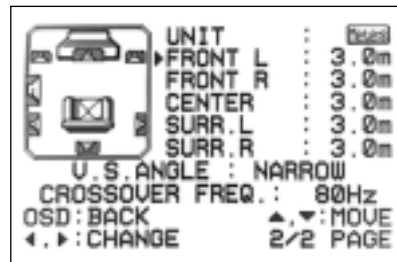
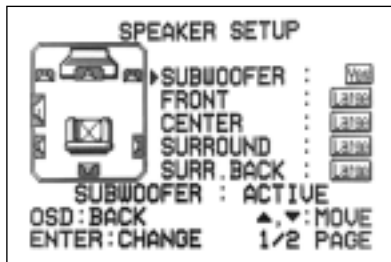

■ When selecting the **FUNCTION SELECT**

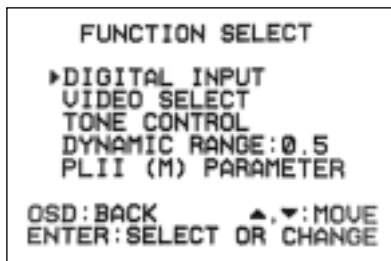

■ When selecting the **SURROUND MODE**

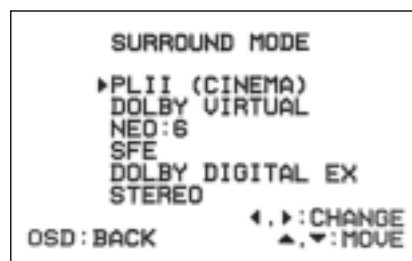

- Only when one of TUNER, TAPE, 7 CH DIRECT and AUX is selected, you can select a video input source on the VIDEO SELECT menu and enjoy the audio and video signals separately.
- When dubbing them onto VIDEO 1, select either VIDEO 2 or VIDEO 3 on the VIDEO SELECT menu.
- The displayed surround mode changes depending on the input signal format.(Refer to “Selecting the surround mode” page 24.)

■When selecting the CH LEVEL SETUP

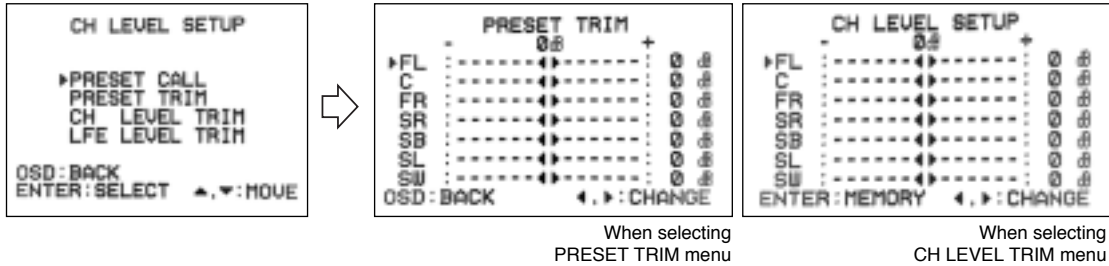

- You can adjust the preset channel level in PRESET TRIM menu. The adjusted is(are) memorized in preset channel level.
- You can adjust the current channel level in CH LEVEL SETUP mode. The adjusted is(are) just memorized, not in preset channel level.
- If you press ENTER button on the remote control unit after adjusting the current channel level in CH LEVEL SETUP menu, that setting is memorized in preset channel level. You can load it again by selecting PRESET CALL.

■When selecting the AUTO OSD

- Each time the ENTER button is pressed, the AUTO OSD mode is set to ON to turn on the current display or OFF to turn it off.
- When the AUTO OSD mode is set to ON, the current status display overlays the program image on the monitor TV and may interference with your movie enjoyment. In such a case, set it to OFF.

4 Select the desired menu or(and) change the condition with the corresponding buttons.

5 Repeat the above steps 2~4 to change the conditions on other menus.

■Notes:

- OSD function on this unit can display all the settings.
- According to your selections for the input source, input signal, decoding mode, surround mode, speaker settings, etc., the conditions of each menu may differ.
- When adjusting the speaker distance or channel level, etc., use the CURSOR LEFT(◀) and RIGHT(▶) buttons.
- In OSD, the parenthesized passage means that it is changeable by pressing CURSOR LEFT(◀) and RIGHT(▶) buttons.

Troubleshooting Guide

If a fault occurs, run through the table below before taking your receiver for repair.

If the fault persists, attempt to solve it by switching the receiver off and on again. If this fails to resolve the situation, consult your dealer. Under no circumstances should you attempt to repair the receiver yourself. This could void the warranty.

PROBLEM	POSSIBLE CAUSE	REMEDY
No power	<ul style="list-style-type: none"> The AC input cord is disconnected. Poor connection at AC wall outlet or the outlet is inactive. 	<ul style="list-style-type: none"> Connect the cord securely. Check the outlet using a lamp or another appliance.
Power shuts off abruptly during operation	<ul style="list-style-type: none"> ※ The protection circuit is activated by the following causes. Speaker terminals are short-circuited. Speaker settings are not adjusted correctly. This unit is operated for long periods of time at extreme sound levels. 	<ul style="list-style-type: none"> ※ Should this happen, do the following steps. Switch off the power and check the speaker connections. Adjust the speaker settings correctly. Adjust the volume low.
No sound	<ul style="list-style-type: none"> The speaker cords are disconnected. The master volume is adjusted too low. The MUTE button on the remote control is pressed to ON. Incorrect selection of the input source. Incorrect connections between the components. 	<ul style="list-style-type: none"> Check the speaker connections. Adjust the master volume. Press the MUTE button to cancel the muting effect. Select the desired input source correctly. Make connections correctly.
No sound from the surround speakers	<ul style="list-style-type: none"> Surround mode is switched off (stereo mode). Master volume and surround level are too low. A monaural source is used. Surround speaker setting is "N". 	<ul style="list-style-type: none"> Select a surround mode. Adjust master volume and surround level. Select a stereo or surround source. Select the desired surround speaker setting.
No sound from the center speaker	<ul style="list-style-type: none"> Dolby Virtual, stereo mode, etc. is selected. Center speaker setting is "N". Master volume and center level are too low. 	<ul style="list-style-type: none"> Select the desired surround. Select the desired center speaker setting. Adjust master volume and center level.
No sound from the surround back speaker	<ul style="list-style-type: none"> The input signal format or the current surround mode cannot support the 6.1 surround playback. Master volume and surround back level are too low. Surround back speaker setting is "N". 	<ul style="list-style-type: none"> Under the proper situations, perform the 6.1 surround playback. Adjust master volume and surround back level. Select the desired surround back speaker setting.
Stations cannot be received	<ul style="list-style-type: none"> No antenna is connected. The desired station frequency is not tuned in. The antenna is in wrong position. 	<ul style="list-style-type: none"> Connect an antenna. Tune in the desired station frequency. Move the antenna and retry tuning.
Preset stations cannot be received	<ul style="list-style-type: none"> An incorrect station frequency has been memorized. The memorized stations are cleared. 	<ul style="list-style-type: none"> Memorize the correct station frequency. Memorize the stations again.
Poor FM reception	<ul style="list-style-type: none"> No antenna is connected. The antenna is not positioned for the best reception. 	<ul style="list-style-type: none"> Connect an antenna. Change the position of the antenna.
Continuous hissing noise during FM reception, especially when a stereo broadcast is received.	<ul style="list-style-type: none"> Weak signals. 	<ul style="list-style-type: none"> Change the position of the antenna. Install an outdoor antenna.
Continuous or intermittent hissing noise during AM reception, especially at night.	<ul style="list-style-type: none"> Noise is caused by motors, fluorescent lamps or lightning, etc. 	<ul style="list-style-type: none"> Keep the receiver away from noise sources. Install an outdoor AM antenna.
Remote control unit does not operate.	<ul style="list-style-type: none"> Batteries are not loaded or exhausted. The remote sensor is obstructed. 	<ul style="list-style-type: none"> Replace the batteries. Remove the obstacle.
OSD function is not available	<ul style="list-style-type: none"> Video connections between this unit and the TV monitor are not made correctly. 	<ul style="list-style-type: none"> Make proper video connections.

Specifications

ENGLISH

• Amplifier Section

Power output, stereo mode, 6 Ω , THD 0.3 %, 40 Hz~20 kHz | **2 x 100 W**

Total harmonic distortion, 6 Ω , 50 W, 1 kHz | **0.09%**

Intermodulation distortion

60 Hz : 7 kHz = 4 : 1 SMPTE, 6 Ω , 100 W | **0.1%**

Input sensitivity, 47 k Ω

Line (AUX) | **200 mV**

Signal to noise ratio, IHF "A" weighted

Line (TAPE) | **95 dB**

Frequency response

Line (AUX, TAPE), 20 Hz~44 kHz | **± 3 dB**

Output level

TAPE OUT, 2.2 k Ω | **180 mV**

Bass/Treble control, 100 Hz/10 kHz | **± 10 dB**

Surround mode, only channel driven

Front power output, 6 Ω , 1 kHz, THD 0.3 % | **100 W+100 W**

Center power output, 6 Ω , 1 kHz, THD 0.3 % | **100 W**

Surround power output, 6 Ω , 1 kHz, THD 0.3 % | **100 W+100 W**

Surround back power output, 6 Ω , 1 kHz, THD 0.3 % | **100 W**

• Digital Audio Section

Sampling frequency | **32, 44.1, 48, 96 kHz**

Digital input level

Coaxial, 75 Ω | **0.5 Vp-p**

Optical, 660 nm | **-15 ~ -21 dBm**

• Video Section

Video format | **PAL**

Input sensitivity(=Output level), 75 Ω

Video (Composite(normal)) | **1 Vp-p**

S-Video (luminance signal) | **1 Vp-p**

(chrominance signal) | **0.286 Vp-p**

• FM Tuner Section

Tuning frequency range | **87.5~108 MHz**

Usable sensitivity, THD 3%, S/N 26 dB | **17.2 dBf**

46 dB quieting sensitivity, mono/stereo | **20.8/41.2 dBf**

Signal to noise ratio, 1 mV, mono/stereo | **72/65 dB**

Total harmonic distortion, 1 kHz, mono/stereo | **0.2/0.4 %**

Frequency response, 20 Hz~15 kHz | **± 1 dB**

Stereo separation, 65 dBf, 1 kHz | **45 dB**

Capture ratio | **4 dB**

IF rejection ratio | **120 dB**

• AM Tuner Section

Tuning frequency range | **522~1611 kHz**

Usable sensitivity | **500 μ V/m**

Signal to noise ratio | **40 dB**

Selectivity | **25 dB**

• General

Power supply | **AC 220 - 240 V, 50/60 Hz**

Power consumption | **110 W**

Dimensions (W x H x D) | **435 x 73.5 x 254 mm (17-1/8 x 2-7/8 x 10 inches)**

Weight (Net) | **4.2 kg (9.3 lbs)**

Note: Design and specifications are subject to change without notice for improvements.

Appendix

INITIALIZING THE SYSTEM

- When the display is not normal or when the operation of the unit does not shows the reasonable result, the initialization of this unit is required by the following procedure.

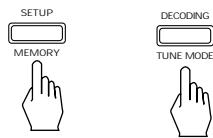
<p>1 In standby mode, press SETUP and DECODING buttons at the same time.</p> 	<p>2 After seeing the flickering standby indicator, take your hand(s) off from buttons.</p> <ul style="list-style-type: none">• If this unit has been reset, all the button settings are reset to the default values (the values set upon shipment from the factory).
---	--



SETTING UP THE SYSTEM ON FRONT PANEL

- You can adjust the system settings in succession according to your system using the buttons on the front panel.
- This section explains how to adjust the settings using the buttons on the front panel.
- Refer to the corresponding pages indicated in () for details about each mode and use of remote control.

- 1** Press the SETUP button for more than 2 seconds, then it enters the setup mode. While displaying the setup mode, each time the SETUP button is pressed, the setup mode changes as follows:
- 2** While displaying the selected setup mode, each time the DECODING button is pressed, the setting mode changes as follows:
- 3** While displaying the selected setting mode, each time the ADJUST UP(▲) or DOWN(▼) button is pressed, the mode is adjusted to the desired setting.

■Notes:

- Only when selecting preset channel levels, press ADJUST UP(▲) or DOWN(▼) button to change the setting mode and DECODING button to confirm your decision(refer to page 26).
- If the display of the corresponding mode disappears, start from the step 1 again.
- To help your understanding, each setting operation is explained with using its default setting.

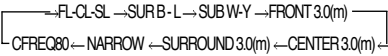
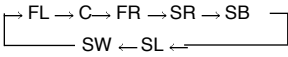
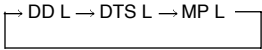
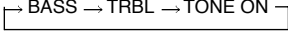
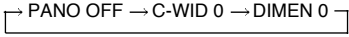
<p>[1]</p> 	<p>[2]</p> 	<p>[3]</p> 
<p>Surround mode : not available when the input signal is 96kHz PCM or headphone is used.</p>	<p>STEREO(or 2 CH DOWNMIX) mode (): Possible when the digital signals from the DTS or Dolby Digital program sources are being input.</p>	<p>Turn back to previous surround mode and select the desired surround mode. (For details, refer to "Selecting the surround mode" on page 24.)</p>
<p>Speaker setup mode ("FL - CL - SL")</p>		<p>Adjust the selected mode as desired. (For details, refer to "Adjusting the speaker settings" on page 19.)</p>
<p>Channel level trim mode ("FL 0")</p>		<p>Adjust the level of the selected channel as desired. (For details, refer to "Adjusting each channel level" on page 25.)</p>
<p>[1] Preset channel level mode ("P CALL")</p>	<p>[3] Confirm your decision.</p>	<p>[2] Select Preset Call or Preset Memory as desired.</p>
<p>LFE channel level mode ("DD L")</p>		<p>Adjust the level of the selected LFE channel as desired. (For details, refer to "Adjusting the LFE channel level" on page 27.)</p>
<p>Tone mode ("BASS" or "TONE OFF") : available only when STEREO is selected during that analog or PCM signal is input.</p>	 <p>• While displaying "TONE OFF", you cannot adjust the tone.</p>	<p>Adjust the tone as desired. (For details, refer to "Adjusting the tone (bass and treble)" on page 26.)</p>
<p>Dynamic range mode ("DYNR 0.0") : available only when the input signal is Dolby Digital.</p>	<p>Ignore this step and skip to the step 3.</p>	<p>Select the desired setting. (For details, refer to "compressing the dynamic range(Dolby Digital sources only)" on page 28.)</p>
<p>Dolby Pro Logic II Music Parameter mode ("PANO OFF") : available only when the current surround mode is Dolby Pro Logic II Music.</p>		<p>Adjust the selected parameter as desired. (For details, refer to "Adjusting the Dolby Pro Logic II Music parameters" on page 29.)</p>

SETUP CODE TABLE

TV

ADMIRAL	050	134					
AKAI	093	049	123				
ALBA	068						
ALBIRAL	116						
ALCATEL	022						
AMSTRAD	000	021					
ANAM	155	156	157				
ARC EN CIEL	028	039	043	145	081		
ARISTONA	099	049	050	019	142	149	
	078						
ARTHUR MARTIN	053	139	117	120	122	123	
	125	128					
ASA	050	055	057	113	134		
ATLANTIC	099	111					
AUDIOSONIC	054						
AUSIND	053						
AUTOVOX	099	144	055	019	057	069	
BAIRD	083						
BASICLINE	006						
BAUR	011						
BEKO	023	049					
BLAUPUNKT	094	100	102	111	114		
BRANDT	028	039	040	043	145	081	
BRION VEGA	050						
BRUNS	048	050					
BSR	059	110	132				
BUSH	033	068	124	074			
CENTURY	098	101	050	079	136		
CGE	016	101	124	079	132	136	
CIHAN	065						
CLARIVOX	048	116					
CONDOR	099	111					
CONTEC	087						
CONTINENTAL							
EDITION	028	039	040	043	145	081	
CROSLEY	101	050	109				
CROWN	147						
CTC CLATRONIC	046						
DAEWOO	089						
DECCA	099	060	063	115	118		
DEGRAAF	036						
DIXI	049	090					
DRYNATRON	049						
DUAL	099	141					
DUAL-TEC	096	099	132				
DUMONT	046	050	057	073			
ELBE	016	116					
ELBIT	065						
ELCIT	046	097	103	050	109	127	
	132						
ELMAN	046	132					
ELTA	090						
EMERSON	158	098	050				
ERRES	049	142					
EUROPHON	098	046	097	099	051	115	
	132						
FERGUSON	146	040	041	150	057	061	
	116	149					
FIDELITY	099	149					
FINLUX	034	046	053	055	057	109	
	113	073	074	079			
FISHER	015	048	050	052	109	136	
FORGESTONE	149						
FORMENTI	099	053	109	111	125		
FORTRESS	137						
FRABA	075						
FRONTECH	054						
FUJITSU	025						
FUNAI	054	059					
GBC	109	132					
GEC	099	060	109	115	134	088	
GELOSO	103	109	132	134	090		
GOLDSTAR	092	003	017	099	049	075	
	076	077	090	152			
GOODMANS	033	049	060	077			
GORENJE	066	136					
GREATZ	001	058	109	122	123	128	
	129	130	134				
GRANADA	033	099	049	058	060	142	
	115	125	134				
GRUNDIG	094	100	057	058	108	112	
	114	082					
HANSEATIC	033	047	099	049	109	139	
	111						
HANTAREX	097						
HEMMERMANN	127						
HIFIVOX	028	039	043	145	081		
HINARI	158	033	045	143	090		
HITACHI	014	033	034	036	099	145	
	056	109	139	110	067	117	
	132	134	084	091	081	088	
HYPER	093	099					
IMPERIAL	016	101	124	079	132	133	
INGELEN	001	058	109	122	128	129	
	130	134					

INNO HIT	093	098	097	099	143	077
	090					
INTERFUNK	047	049	050	145	058	109
	142	123	128	129	091	
IRRADIO	093	143	053	077	090	
ITT	001	140	058	105	109	122
	123	128	148	129	130	134
	135	083	089			
JVC	033	154				
KTV	099					
KAISUI	006					
KARCHER	006					
KENDO	098					
KENNEDY	144	019	109			
KORTING	050	059	111			
KRIESLER	099	049	050	019	142	149
	078					
LENOIR	099					
LOEWE OPTA	008	097	047	049	050	115
	072					
LOGIK	118	149				
LUMA	049	120	134			
LUXOR	058	139	117	120	123	129
	135	083				
MAGNADYNE	046	097	103	050	109	115
	127	132				
MAGNAFON	046	097	099	051	053	115
MARANTZ	049					
MATSUI	158	099	106	060	118	068
	134	090				
McMICHAEL	088					
MEMOREX	090					
METZ	094	050	114	133		
MINERVA	094	100	057	058	114	
MISTRAL	149					
MITSUBISHI	033	035	047	049	050	062
	118	119	148	080	138	
MIVAR	097	099	115	077		
MULTITECH	046	099	115	136		
MURPHY	134					
MAONIS	096	144	019	110	134	
NATIONAL	042	104	109			
NEC	033	085				
NECKERMANN	099	050	139	120	136	
NEI	049					
NIKKAI	060					
NOBLEX	015					
NOBLIKO	098	046	099	053	057	
NOGAMATIC	028	039	043	145	081	
NOKIA	001	140	058	105	109	122
	123	128	148	129	130	134
	135	083	089			

NORDMENDE	028	032	039	043	145	131
	091	081				
OCEANIC	109	064	123			
ONCEAS	099					
OPTONICA	137					
ORION	000	059	118	068	127	090
OSAKI	060					
OSIO	077					
OSUME	087					
OTTO VERSAND	033	047	049	109	139	
P.T ACTTRON	065					
PAEL	099	053				
PANASONIC	030	042	095	104	107	109
	121	126				
PATHE CINEMA	099	111	116	132		
PERDIO	060					
PHILCO	016	030	101	050	109	124
	079	132	136			
PHILIPS	009	010	013	018	024	099
	049	050	019	142	148	149
	078	088				
PHOENIX	099	053	109	111	125	
PHONOLA	099	049	050	019	142	149
	078					
PIONEER	020	049	145	091		
PRANDONI-						
PRINCE	098	097	053	115	134	
PREMIER	124					
PRINCE	098	097	053	134		
PROTECH	049	054				
PYE	099	049	050	019	142	148
	149	078				
QUASAR	046	097	051	053	077	
QUELLE	047	099	100	049	053	055
	057	058	111	112	113	114
	118	123	073	074	128	
RADIOLA	099	049	050	019	142	149
	078					
RADIOMARELLI	046	097	103	050	109	062
	127	132				
RANK	074					
RBM	074					
REDIFFUSION	062	123	134			
REX	096	144	019	141	110	069
	134					
ROBOTRON	048	050				
RTF	048	050				
SABA	028	031	032	037	039	040
	043	097	050	145	115	120
	086	091	081			
SAISHO	158	099	118	119	068	090
SALORA	053	139	117	120	122	123
	125	128	135	083		

SAMBERS	046	097	051	053	115	077
SAMPO	121					
SAMSUNG	015	026	099	054	077	136
	090	151	153			
SANYO	001	002	005	033	044	048
	060	113	118	071	054	136
SBR	049	142	148	149	088	
SCHAUB LORENZ	001	058	109	122	123	128
	129	130	134			
SCHNEIDER	096	099	049	050	052	019
	141	109	142	125	149	078
	132					
SEG	046					
SEI	158	059				
SELECO	016	096	144	019	141	110
	069	134				
SHARP	033	087	137			
Sherwood	000					
SIAREM	046	097	050	109	115	
SICATEL	116					
SIEMENS	005	094	036	100	111	114
	087					
SIERA	099	049	050	019	142	149
	078					
SILVER	054					
SINGER	016	046	050	109		
SINUDYNE	158	046	050	059	109	127
SONOKO	049	090				
SONY	146	007	027	033	038	118
STERN	096	144	019	110	069	134
TANDBERG	133					
TANDY	099	060	137			
TASHIKO	002	033				
TATUNG	099	060	063	065	115	118
TEC	096	099	132			
TELEAVIA	028	039	040	043	145	091
	081					
TELEFUNKEN	028	041	145	150	086	091
TELETECH	090					
TELEVIDEON	099	053	109	111	125	
TENSAI	049					
THOMSON	012	028	032	039	040	043
	145	091	081			
THORN- FERGUSON	014	040	041	054	150	057
	061	116	149	086		
TOCOM	029					
TOSHIBA	004	016	033	070	074	
TRANS						
CONTINENTS	098	097	053	134		
TRIUMPH	158					
UHER	052	111	125			
ULTRA VOX	098	046	099	050	109	120

UNIVERSUM	092	034	054	077		
UNIVOX	116					
VEGAVOX	079					
VOXSON	050	134				
WATSON	111					
WATT RADIO	046	099	051	109	116	127
WEGA	033					
WHITE						
WESTINGHOUSE	099	111				
YOKO	099					
ZANUSSI	096	144	019	110	069	134
ZOPPAS	096	144	019	110	134	

VCR

AKAI	042	022	052	032	033	
ALBA	008	020				
AMSTRAD	011					
ANITSCH	009					
ARC EN CIEL	042	056	052			
ARISTONA	045	031				
ASA	018					
AWIA	011	042				
BAIRD	042	033				
BAUER. BOSCH	014	043				
BLAUPUNKT	014	043	055	031	054	040
BRANDT						
ELECTRONIQUE	042	056	052			
BRIONVEGA	041					
BUSH	008	020				
C.EDISON	041					
CANON	014					
CAPEHART	020					
CGE	011	042	052			
CONTINENTAL						
EDISON	042	056	052			
CRAIG	000	013				
CURTIS MATHES	019					
DAEWOO	001	020	021			
DAYTRON	020					
DECCA	011	042				
DEGRAAF	003	006	011	045	018	
DUAL	042	052				
DUMONT	003	011	018			
DYNATECH	011					
EMERSON	002	010	011	019	025	
FERGUSON	042	059	030	052	034	036
FIDELITY	011					
FINLANDIA	003	018				
FINLUX	003	006	011	018		
FISHER	000	003	005			

ENGLISH

FUNAI	011					
GE	019					
GENERAL	014					
GOLDSTAR	004	062				
GOODMANS	008	011	046			
GRAETZ	041	042	056	050	052	038
GRANADA	003	005	018			
GRUNDIG	014	043	018	055	031	053
	054					
HANSEATIC	043					
HARMAN- KARDON	004					
HIFIVOX	042	056	052			
HINARI	002	008	024	027		
HITACHI	006	007	011	042	057	
IMPERIAL	011					
INGELEN	042	056	052	038		
INGERSOL	027					
ITT	005	041	042	056	050	052
	033	038				
JENSEN	042					
JVC	042	056	060	030	052	063
KENWOOD	005	042	060			
KRIESLER	045	031				
KUBA	043					
LLOYD	011					
LOEWE OPTA	014	018	029	031		
LOGIK	008	027				
LUXOR	033	038				
MAGNADYNE	041					
MAGNASONIC	038					
MAGNAVOX	019					
MARANTZ	004	014	046	018	031	
MATUI	010	025	027			
MEMOREX	000	003	005	011	045	
METZ	014	043	031	054	037	
MGA	017					
MINERVA	055	054				
MINOLTA	006	007				
MITSUBISHI	060	017	049			
MTC	011	013				
MULTITECH	008	011				
MURPHY	011					
NAONIS	042	056	052			
NATIONAL	040					
NEC	004	042	060	052		
NECKERMANN	002	041	014	042	052	
NOGAMATIC	042	056	052			
NOKIA	003	005	041	042	056	050
	052	033	038			
NORDMENDE	039	042	056	052	053	035
OPTONICA	045	046				
ORION	002	010	025	027		

OSAKI	011					
OTTO VERAND	043					
P. CINEMA	014					
PALLADIUM	041	014				
PANASONIC	023	051	040			
PATHE MARCONI	042	056	052			
PENTAX	006	007				
PERDIO	011					
PHILIPS	012	014	045	046	018	029
	031					
PHONOLA	014	045	018	029	031	
PIONEER	060					
PORTLAND	020					
PROLINE	011					
PYE	014	045	018	029	031	
QUARTZ	005					
QUELLE	002	044	054			
RADIOLA	045	031				
RADIOMARELLI	041					
RCA	019					
REALISTIC	000	003	005	011	013	045
	046					
REX	042	056	052			
SABA	039	042	056	052	035	
SAISHO	002	010	025	027		
SALORA	005	017				
SAMSUNG	013	019	032	061		
SANSUI	042	060				
SANYO	000	003	005	025	038	
SBR	018	029				
SCHAUB LORENZ	041	042	056	050	052	038
SCHNEIDER	008	011	045	031		
SEI-SINUDYNE	027					
SELECO	042	056	052			
SENTRA	020					
SHARP	045	046	105	048		
SHINTOM	008					
SIEMENS	014	043	055	031	054	038
SIERA	045	031				
SINUDYNE	027					
SONY	044	015	016	026	028	
STERN	042	056	052			
STS	006					
SUNKAI	025					
SYLVANIA	011	017				
SYMPHONIC	011	017				
TASHIKO	011					
TATUNG	011	042				
TEAC	011	042				
TEKNIKA	011					
TELEAVIA	042	056	052			
TELEFUNKEN	042	056	052			
TENOSAL	008					

THOMSON	042	056	052			
THORN- FERGUSON	039	042	059	030	052	034
	036					
TOSHIBA	001	042	056	017	058	052
TOTELEVISION	013					
UHER	042					
ULTRA VOX	041					
UNITECH	013					
UNIVERSUM	041	014	043			
URANYA	041					
VECTOR	004					
VICTOR	042	060				
VIDITAL	041					
WESTING HOUSE	041					
WARDS	019					
YAMAHA	004	042				
ZANUSSI	042	056	052			
ZENDER	052					
ZOPPAS	042	056				

DVD

DENON	017					
GE	003	004				
JVC	007					
LG	011	010				
MAGNAVOX	019					
MITSUBISHI	001					
ONKYO	009					
PANASONIC	015					
PHILIPS	019					
PIONEER	002	023				
PROSCAN	003	004				
RCA	003	004				
SAMSUNG	016	008				
SHERWOOD	000	010	011	012	013	014
	022	020	021			
SONY	005					
THOMSON	003	004				
TOSHIBA	006					
VIETA	014					
YAMAHA	019					
ZENITH	011	010				

CBL

ABC	002	003	009	030		
	007	006	008			
Allegro	018	021				
Archer	018	026				
Bell&Howell	009					
Century	018					
Citizen	018	021				
Comtronics	014					
Contec	011					
Easten	001					
Emerson	026					
Everquest	010	014				
Focus	022					
Garrard	018					
Gemini	010					
General Instrument	033	276	006	034		
GoldStar	017	040				
Goodmind	026					
Hamlin	012	020	004	013		
Hitachi	006					
Hytex	007					
Jasco	010	018	021			
Jerrold	002	007	033	032	009	010
	006	034				
Memorex	000					
Movie Time	015					
NSC	015					
Oak	011					
Optimus	031					
Panasonic	000	016	031			
Paragon	000					
Philips	018					
Pioneer	017	025				
Popular Mechanics	022					
Pulsar	000					
Quasar	000					
RCA	031					
Radio Shack	010	021	026	028		
Recoton	022					
Regal	012	020				
Regency	001					
Rembrandt	006					
Runco	000					
SL Marx	014					
Smasung	017	014				
Scientific Atlanta	003	023	030	027		
Signal	010	014				
Signature	006					
Sprucer	031					
Starcom	002	010				

ENGLISH

Stargate	010	014	026
Starquest	010		
TV86	015		
Teleview	014		
Tocom	007	008	
Toshiba	000		
Tusa	010		
Unika	018		
United Artists	007		
Universal	153	019	
Viewstar	015		
Zenith	000	024	
Zentek	022		

SAT

ALBA	030			
AMSTRAD	008	019	027	
ARCON	021			
ARISTONA	016			
ASTRA	028			
BLAUPUNKT	033			
BUSH	016			
CH.MASTER	030			
CITY COM	005			
DDC	030			
DYNASAT	005			
ECHOSTAR	002	009	032	020
EMME ESSE	005			
FAIT	005			
FERGUSON	014	041	016	017 018
FINLUX	006	007	013	
FRACARRO	005			
FTE	022			
GOLDSTAR	004	021		
GRAETZ	026	037		
GROTHUSEN	004			
GRUNDIG	033	016	018	036
HINARI	030			
HIRSCHMANN	003	006		
HITACHI	013			
INGELEN	026	037		
ITT	034			
ITT-NOKIA	032	018	026	037
JERROLD	038	014		
KATHREIN	005	022	023	
KOSMOS	004			
KRIESLER	016			
LENCO	004	021		
LUXOR	026	037		

MAGAI	022			
MARANTZ	012			
MASPRO	016			
MATSUSHITA	000			
METZ	036			
MINERVA	036			
MULTISTAR	022			
MURATO	004			
NEC	040			
NEIRU	021			
NOKIA	026	037		
NORSAT	015			
PACE	001	042	016	017 018 044
PANASONIC	032			
PHILIPS	003	011	012	029
PHONOLA	016			
PROSAT	030			
PYE	016			
QUADRAL	030			
QUELLE	036			
RADIOLA	016			
REDIFFUSION	015			
SABA	035			
SALORA	026			
SAMSUNG	003	022		
SAT PARTNER	004			
SATPORTNER	021			
SCHAUB LORENZ	026	037		
SCHNEIDER	005	016		
SIEMENS	033	036		
SIERA	016			
SILVA	004	021		
SKY	039			
STARCOM	038			
STARSAT	022			
TECHNISAT	003			
TELEFUNKEN	025			
TELESYSTEM	005			
THORN- FERGUSON	010	014	041	016 017 018
	043			
TRIAD	004			
UNIDEN	022			
UNITED CABLE	038			
V TECHNOLOGY	004			
VORTEC	003	024	025	
ZENDER	022			

CD

ADCOM	021					
AIWA	045	039	022			
AKAI	046					
AUDIO	016					
ARC EN CIEL	036	014	027	030	031	018
	230					
DENON	054					
FISHER	006					
H/K	017	012	047	016		
JVC	028	034	001			
KENWOOD	003	020	010	029	006	
MARANTZ	015	014				
MONDIAL	033					
NAD	048	002	042			
NAKAMICHI	049					
NIKKO	016					
ONKYI	013	037	011	021	038	
PANASONIC	051	052				
PHILIPS	014					
PIONEER	005	008	041			
RCA	007	009				
REALISTIC	045					
SANSUI	040					
SHARP	019	053				
SHERWOOD	000	035	023	019	056	057
	058					
SONY	050	024	025	026		
TEAC	055	032				
TECHNICS	051	004	052			
VICTOR	001					
YAMAHA	044	043	016			

AUX-TAPE/MD

SHERWOOD	000(for tape deck)
	015 016(for MD recorder)

AUX-LD

DAEWOO	002
DENON	012
GOLDSTAR	004
KENWOOD	003
MAGNAVOX	010
OPTIMUS	007
PANASONIC	013
PHILIPS	010
POINNEER	000 009
RCA	006
REALISTIC	007
SAMSUNG	001 005
SHARP	003 011
TECHINCS	013
TOSHIBA	003
YAMAHA	008