

# PS-LX350H

## SERVICE MANUAL

US Model  
AEP Model  
UK Model  
E Model



### SPECIFICATIONS

#### Motor and Platter

Drive system	Belt-drive
Motor	DC motor
Platter	330 mm dia. Aluminum die-cast
Speeds	33 $\frac{1}{3}$ and 45 r/min, 2 speed
Wow and flutter	Less than 0.25% (WRMS)
Signal to noise ratio	More than 50 dB (DIN-B)

#### Tone Arm

Type	Static balanced S-shaped tone arm with detachable headshell
Effective arm length	220 mm
Overhang	10 mm
Usable cartridge weight	6 g (min.) to 10 g (max.)

#### General

Power requirements	U.S.A : 120V AC, 60Hz European countries: 220 ~ 230 V AC, 50/60 Hz Other countries: 110 ~ 120 V/220 ~ 240 V AC, 50/60 Hz
Power consumption	8 W
Dimensions	Approx. 450 x 145 x 350 mm (17 $\frac{11}{16}$ x 5 $\frac{11}{16}$ x 13 $\frac{3}{4}$ in) (w/h/d)
Mass	6.5 kg (14 lb 5 oz)

#### Supplied Accessories

45 r/min adaptor (1)
Platter (with drive belt) (1)
Rubber mat (1)
Cartridge and headshell (1)
Counter weight (1)
Audio connecting cord (1)
Dust cover (1)

Design and specifications are subject to change without notice.

### Replacing the Stylus

The life expectancy of the stylus tip is about 500 hours. To preserve maximum sound quality and avoid damage to your records, we recommend replacing the stylus within this time limit.

Additional replacement styli (ATN3600LX) are available from your Sony dealer.

#### To replace the stylus

- 1 Turn off the turntable and amplifier.
- 2 Turn the locking collar and remove the cartridge from the tone arm.
- 3 Grasp the stylus holder and pull it away from the body of the cartridge in the slanting direction.
- 4 Insert the new stylus by pushing it into the cartridge receptacle in the slanting direction until it clicks.

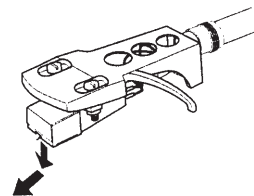

## STEREO TURNTABLE SYSTEM

# SONY®



### Assembling the Turntable

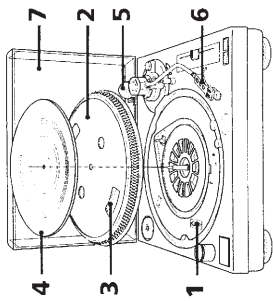

**6** Insert the headshell into the front of the tone arm. Turn the locking collar in the direction of the arrow until the headshell is secure.

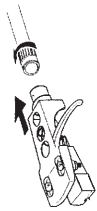

**7** Rise the hinges and install the dust cover.

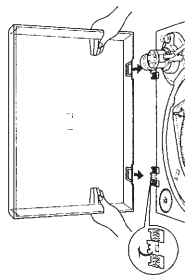

**1** If your turntable is equipped with a voltage selector, be sure to set the selector to your line voltage.



**2** Carefully, place the platter on the spindle.

**3** Using the ribbon, loop the drive belt around the motor pulley. After looping the belt, do not forget to remove the ribbon.

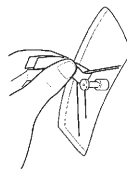

**4** Place the rubber mat on the platter.

**5** Slide the counter weight onto the shaft at the rear of the tone arm and turn 3 or 4 times in the direction of the arrow.

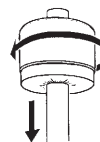

## SECTION 1 GENERAL

This section is extracted from instruction manual.

### SAFETY-RELATED COMPONENT WARNING !!

COMPONENTS IDENTIFIED BY MARK  $\triangle$  OR DOTTED LINE WITH MARK  $\triangle$  ON THE SCHEMATIC DIAGRAMS AND IN THE PARTS LIST ARE CRITICAL TO SAFE OPERATION. REPLACE THESE COMPONENTS WITH SONY PARTS WHOSE PART NUMBERS APPEAR AS SHOWN IN THIS MANUAL OR IN SUPPLEMENTS PUBLISHED BY SONY.

## Adjusting the turntable

Before attempting to play any records, be sure to complete the following steps to insure proper tone arm balance, tracking force and anti-skating adjustment. Failure to complete these adjustments will result in inferior sound quality and may cause permanent damage to the stylus and record.

- 1 Make sure the turntable is level. The insulator feet allow you to make slight adjustments to the height of the turntable.

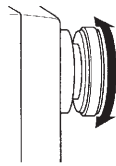

- 2 Set the ANTI-SKATING dial to "0".

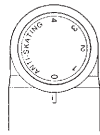

- 3 Remove the protective cover from the cartridge, move the tone arm to the space between the arm stand and the platter. Take care not to damage the stylus.
- 4 While using the finger lift to support the headshell, shift the cueing lever forward. Take care not to damage the stylus.



- 5 Balance the tone arm by turning the counter weight either clockwise or counterclockwise. **When the tone arm is properly balanced** it will float parallel to the platter when released. It should not tilt toward either the headshell or counter weight.

- 6 Return the tone arm to the arm stand.

- 7 Since the tracking force is zero when the tone arm is properly balanced, set the tracking force scale ring so that "0" lines up with the index line. **Hold the counter weight with your other hand so that it will not turn together with the scale ring.**

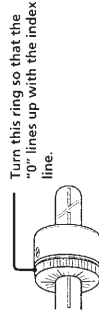

- 8 When using the supplied cartridge, turn the counter weight so that 2 reading lines up with the index line. The supplied cartridge requires 2 grams of tracking force.

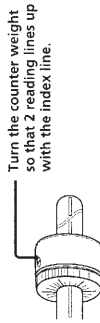

### When optionally available cartridge is used

Turn the counter weight counterclockwise to align the tracking force scale ring to the correct tracking force. The tracking force scale ring is marked in 0.1 g steps and one full turn of the counter weight yields a tracking force of 4 g.

- 9 Set the ANTI-SKATING dial to the same setting as the tracking force scale ring. The numbers on the ANTI-SKATING dial correspond to 1 g of tracking force.

## Playing a Record

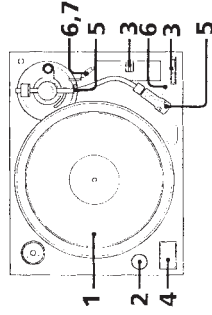

- 1 Place a record on the platter.

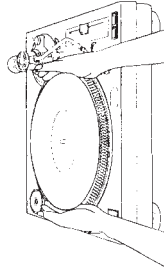

### Note

Place only one record on the platter at a time. If two or more records are stacked on the platter, the stylus will not make proper contact with the grooves and the quality of reproduction will be impaired.

- 2 Turn POWER to "I" to turn on the record turntable. The strobo lamp lights up.
- 3 Set the PITCH CONTROL to the center position and press 33 or 45 to select the platter speed. The indicator for the selected speed lights up.
- 4 Press START/STOP. The platter starts rotating. If you select 45 r/min when the turntable is connected to a 50 Hz power source, the innermost row of the strobo dots should appear to stand still.
- 5 Remove the protective cover from the cartridge and disengage the arm stopper.
- 6 Shift the cueing lever forward. Move the tone arm to the desired position over the record.

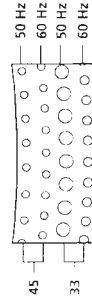

- 7 Set the cueing lever backward. The tone arm descends slowly to the record and playback begins.
  - 8 Adjust the volume on your amplifier.
- To stop playing**
- 1 Shift the cueing lever forward to lift up the tone arm, return the tone arm to the arm stand. Attach the protective cover onto the cartridge to prevent damage to the stylus.
  - 2 Press the START/STOP button. The platter stops rotating. Shift the cueing lever forward and fix the tone arm with the arm stopper.
  - 3 Turn POWER to "0" to turn the turntable off.

### To pause playback

Shift the cueing lever forward to raise the stylus off the record during playback.

### To listen to a different part of the record

- 1 Shift the cueing lever forward to raise the stylus during playback.
- 2 Move the tone arm to the position you desire.
- 3 Shift the cueing lever backward.

### To play a 17-cm record

Place the supplied 45 r/min adaptor on the spindle. When you have finished using the adaptor, put it back in the adaptor tray.

### ⚠ If the strobo dots do not stand still when the PITCH CONTROL is set to the center position

- Slide toward + or - to adjust the platter speed so that the respective strobo dots appear to stand still.

### Note

When the unit is turned on, the speed is automatically set to 33 r/min.

### ⚠ If you have an extra headshell, retain it in the headshell holder.

## SECTION 2 EXPLODED VIEWS

**NOTE:**

- Items marked "\*" are not stocked since they are seldom required for routine service. Some delay should be anticipated when ordering these items.
- The mechanical parts with no reference number in the exploded views are not supplied.

- Hardware (# mark) list and accessories and packing materials are given in the last of this parts list.

The components identified by mark  $\Delta$  or dotted line with mark  $\Delta$  are critical for safety. Replace only with part number specified.

### 2-1. STEREO TURNTABLE SYSTEM-1

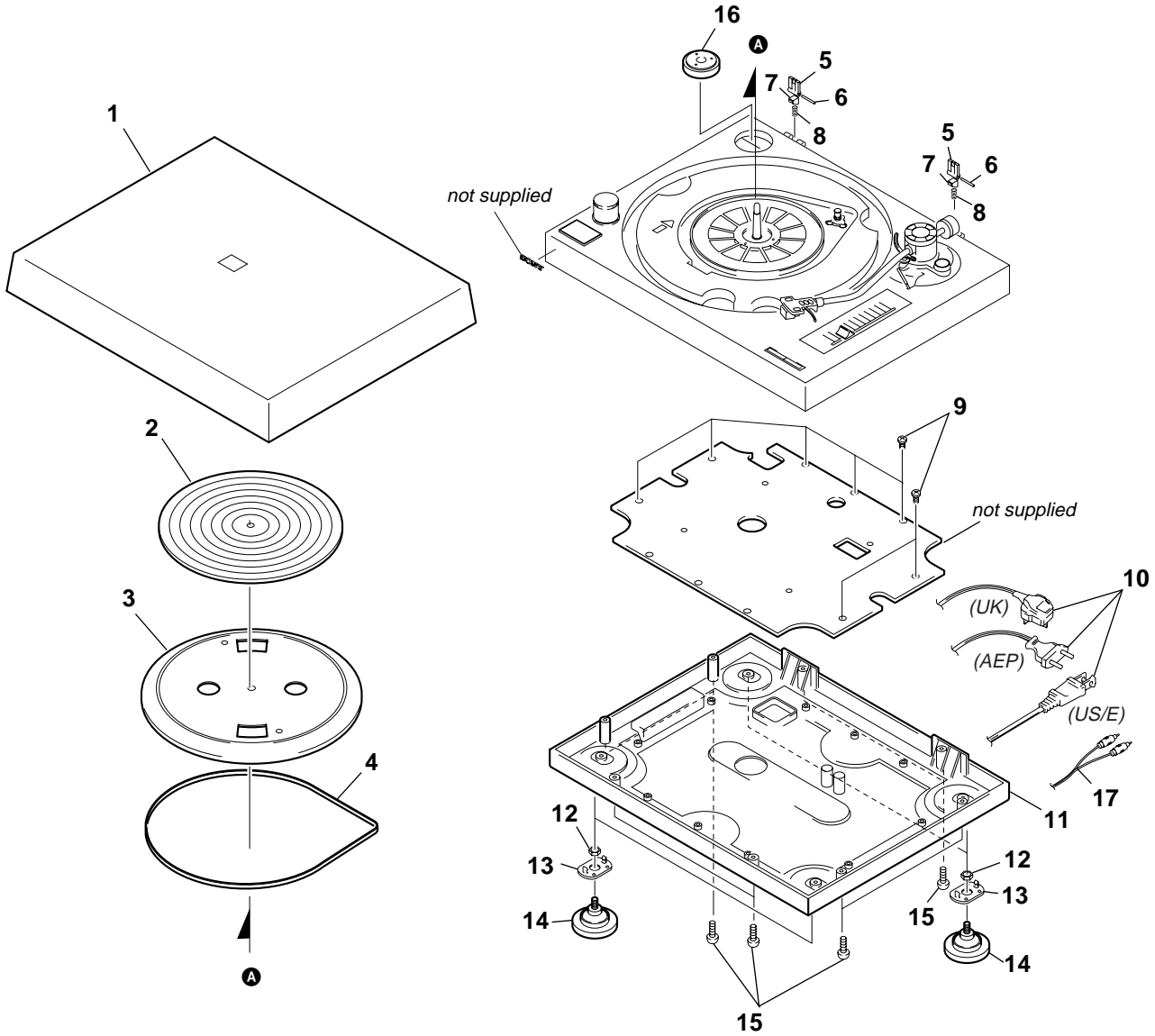

Ref. No.	Part No.	Description
1	4-216-563-01	DUST COVER ASSY
2	4-216-562-01	RUBBER MAT ASSY
3	4-216-559-01	ALUMINIUM PLATTER
4	4-216-560-01	BELT
5	4-216-509-01	HINGE
6	4-216-534-01	HINGE PIN
7	4-216-510-01	HINGE SLIDE
8	4-216-536-01	HINGE SPRING
9	4-216-549-01	SCREW
$\Delta$ 10	1-575-651-11	CORD, POWER (AEP)
$\Delta$ 10	1-696-572-21	CORD, POWER (UK)
$\Delta$ 10	1-575-975-11	CORD, POWER (US/E)

Remark	Ref. No.	Part No.	Description	Remark
	*	11	4-216-545-01	BOTTOM COVER
		12	4-216-548-01	NUT
		13	4-216-546-01	FOOT FIXED PLATE
		14	4-216-542-01	FOOT ASSY
		15	4-216-527-01	SCREW
		16	4-216-558-01	45 RPM ADAPTOR
		17	1-790-432-11	CORD, CONNECTION (AUDIO)

2-2. STEREO TURNTABLE SYSTEM-2

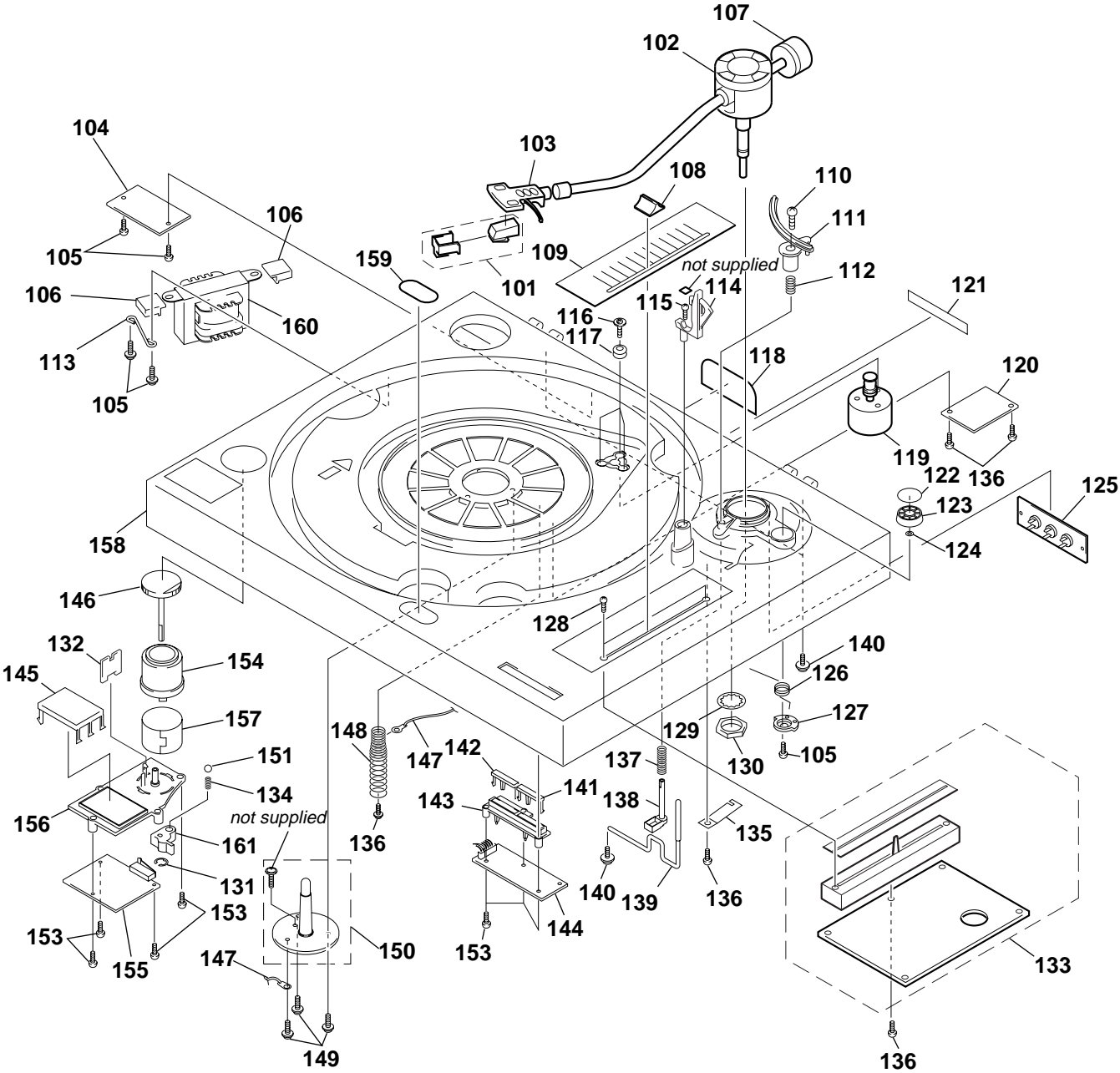

# PS-LX350H

Ref. No.	Part No.	Description	Remark	Ref. No.	Part No.	Description	Remark
101	4-215-490-01	STYLUS (ATN 3600 LX)		146	A-4411-435-A	POWER KNOB ASSY	
102	4-216-555-01	TONEARM ASSY		147	4-216-556-01	LUG TERMINAL ASSY	
103	4-216-561-01	HEAD SHELL ASSY		148	4-216-533-01	SHEILDING SPRING	
* 104	A-4417-994-A	AC BOARD, COMPLETE		149	4-216-525-01	SCREW	
105	4-216-524-01	SCREW		150	4-216-552-01	CENTER SHAFT ASSY	
106	4-216-538-01	CUSHION (TRANS)		151	4-216-503-01	STEEL BALL	
107	4-216-564-01	COUNTER WEIGHT ASSY		153	4-216-529-01	SCREW	
108	4-216-512-01	SPEED PUSH BUTTON		154	4-216-498-01	SPOT LIGHT HOLDER	
109	4-216-517-01	DECORATIONS PLATE		* 155	A-4417-992-A	PLAY/STOP BOARD, COMPLETE	
110	4-216-523-01	SCREW		156	4-216-497-01	BUTTON BASE	
111	4-216-504-01	LIFTER		157	4-216-500-01	PC SHEET	
112	4-216-537-01	LIFTER SPRING		* 158	4-216-507-01	CHASSIS	
113	4-216-535-01	TRANS LEAF SPRING		* 159	4-216-508-01	DECORATIONS PLATE	
114	4-216-544-01	TONEARM LIFTER ASSY		△ 160	1-433-659-11	TRANSFORMER, POWER (US/E)	
115	4-216-522-01	SCREW		△ 160	1-433-959-11	TRANSFORMER, POWER (AEP/UK)	
116	4-216-530-01	SCREW		161	4-216-499-01	TUNING SHAFT	
117	4-216-539-01	RUBBER (MOTOR)					
118	4-216-518-01	DECORATIVE PLATE					
119	4-216-554-01	MOTOR CAPSTON ASSY					
* 120	A-4417-996-A	VELOCITY MODULATE BOARD, COMPLETE					
121	4-216-519-01	OUTPUT LABEL					
122	4-216-516-01	DECORATIVE PLATE					
123	4-216-505-01	MICRO ADJUST KNOB					
124	4-216-541-01	WASHER					
125	4-216-515-01	RCA PLATE					
126	4-216-532-01	MICRO ADJUST SPRING					
127	4-216-506-01	MICRO ADJUST LEVER					
128	4-216-526-01	SCREW					
129	4-216-540-01	WASHER					
130	4-216-520-01	NUT					
131	4-216-502-01	E-WASHER					
* 132	A-4405-766-A	ENON LAMP BOARD, COMPLETE					
* 133	A-4417-995-A	MAIN BOARD, COMPLETE					
134	4-216-501-01	SPRING					
135	4-216-513-01	WASHER					
136	4-216-521-01	SCREW					
137	4-216-531-01	LIFTER SPRING					
138	4-216-551-01	TONEARM BASE ASSY					
139	4-216-553-01	UP/DOWN ASSY					
140	4-216-528-01	SCREW					
141	4-216-550-01	45 KNOB ASSY					
142	4-216-543-01	33 KNOB ASSY					
143	4-216-511-01	BUTTON BASE					
* 144	A-4417-993-A	33/45 SPEED BOARD, COMPLETE					
145	4-216-496-01	START/STOP KNOB					

MISCELLANEOUS  
\*\*\*\*\*

△ 10	1-575-975-11	CORD, POWER (US/E)
△ 10	1-575-651-11	CORD, POWER (AEP)
△ 10	1-696-572-21	CORD, POWER (UK)
△ 160	1-433-659-11	TRANSFORMER, POWER (US/E)
△ 160	1-433-959-11	TRANSFORMER, POWER (AEP/UK)

ACCESSORIES & PACKING MATERIALS  
\*\*\*\*\*

1-790-432-11	CORD, CONNECTION (AUDIO)
3-864-750-11	MANUAL, INSTRUCTION (ENGLISH) (US)
3-864-750-21	MANUAL, INSTRUCTION (ENGLISH, GERMAN, SPANISH, DUTCH, SWEDISH, ITALIAN, PORTUGUESE, FRENCH) (AEP/UK/E)
4-215-490-01	STYLUS (ATN 3600 LX)
4-216-558-01	45 RPM ADAPTOR
4-216-559-01	ALUMINIUM PLATTER
4-216-560-01	BELT
4-216-561-01	HEAD SHELL ASSY
4-216-562-01	RUBBER MAT ASSY
4-216-563-01	DUST COVER ASSY
4-216-564-01	COUNTER WEIGHT ASSY

The components identified by mark △ or dotted line with mark △ are critical for safety. Replace only with part number specified.