

PS-LX62/LX62P

SERVICE MANUAL

Canadian Model
AEP Model
E Model
PS-LX62
E Model
PS-LX62P

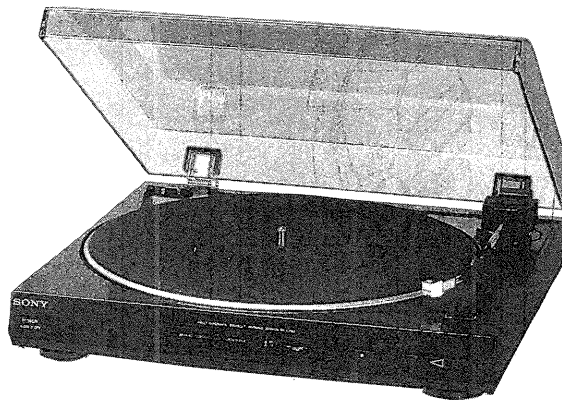

Photo : PS-LX62

SPECIFICATIONS

Turntable

Platter	30 cm (12 in.)
Motor	DC servo motor
Drive system	Belt drive
Speed	33 $\frac{1}{3}$ rpm/45 rpm switchable
Wow and flutter	0.15% (WRMS)
Signal-to-noise ratio	65 dB (DIN-B)
Automatic system	Return, reject, lead in.

Tonearm

Type	Dynamically balanced
Pivot-to stylus length	206 mm (7 $\frac{7}{8}$ in.)
Overall arm length	235 mm (9 $\frac{1}{8}$ in.)

Cartridge

Type	Moving magnet type
Frequency response	20 Hz - 20kHz
Stylus	ND-155G

General

Dimensions	355 × 100 × 340 mm (w/h/d) (14 × 4 × 13 $\frac{1}{2}$ inches)
Weight	Approx. 2.6 kg (4 lb 14 oz)
Power requirements	(PS-LX62) The model for Canadian : 120V AC, 60Hz The model for Europe: 220 V AC, 50/60 Hz The model for other countries: 110 - 120 V, 220 - 240 V adjustable, 50/60 Hz
Power consumption	The model for Europe: 2 W The model for other countries : 4 W
Accessory supplied	45-rpm adaptor (1)
Optional accessories	Replacement stylus ND-155G

Note for Cartridge

Be careful not to use any cartridge except for specified one (Part No.: 1-549-135-11) as balance weight of pick up arm assy is fixed.

REPLACING THE STYLUS

Replace the stylus after about 400 hours of use because using a worn stylus will damage records. An ND-155G replacement stylus is available at your Sony dealer. Be sure to turn the amplifier off before proceeding with replacement.

- 1 While holding the cartridge, detach the stylus assembly as illustrated.
- 2 Insert the new stylus into the cartridge.

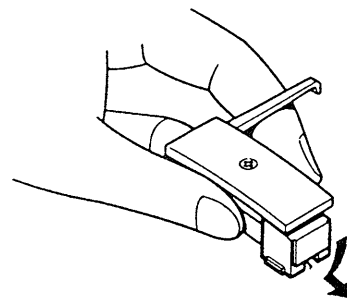

Design and specifications subject to change without notice.

Note

This appliance conforms with EEC Directives 76/889 and 82/499 regarding interference suppression.

STEREO TURNTABLE SYSTEM
SONY®

SECTION 1 GENERAL

LOCATION AND FUNCTION OF CONTROLS

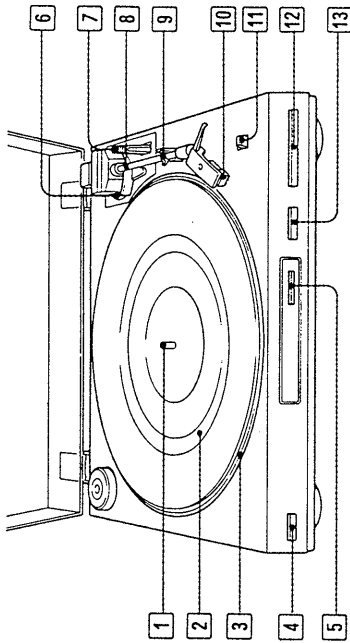

- 1** Center spindle
- 2** Rubber mat
- 3** Turntable platter
- 4** POWER switch (PS-LX62 only)
- 5** SPEED select button
Allows selection of 45 rpm or 33 rpm turntable speed.
- 6** Drop point adjustment hole
- 7** Cueing lever (▼/▲)
- 8** Tonearm
- 9** Arm rest
- 10** Cartridge
- 11** SIZE SELECTOR
Allows selection of 17 cm (7 inch) or 30 cm (12 inch) records.
- 12** ◀(start) button
- 13** ■(stop) button

TO NEARM DROP-POINT ADJUSTMENT

The tonearm drop-point during auto play has been factory-adjusted. If necessary, readjust it as follows.

To move the drop-point toward A, turn the adjustment screw clockwise with a screwdriver.

To move the drop-point toward B, turn the adjustment screw counterclockwise with a screwdriver.

If the tonearm does not return to the arm rest automatically after play
Turn the adjustment screw counterclockwise.

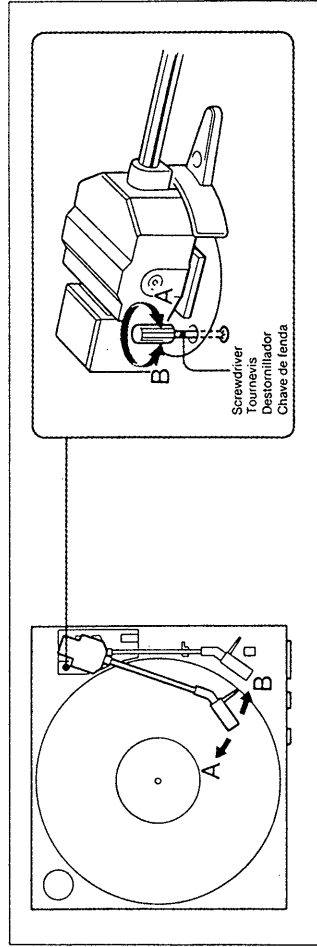

REPAIRING PRECAUTION (PS-LX62P only)

[To supply B+ voltage]

The power of this unit is fed from HST-D501. Because of this, connect the regulated DC power supply as illustrated right when this unit alone operates.

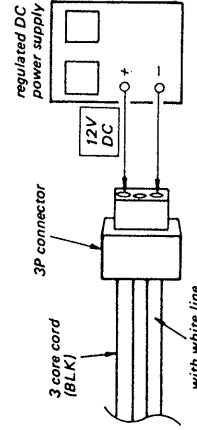

SECTION 2 DIAGRAMS

2-1. SCHEMATIC DIAGRAM

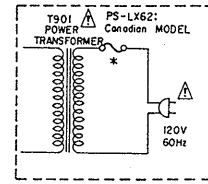
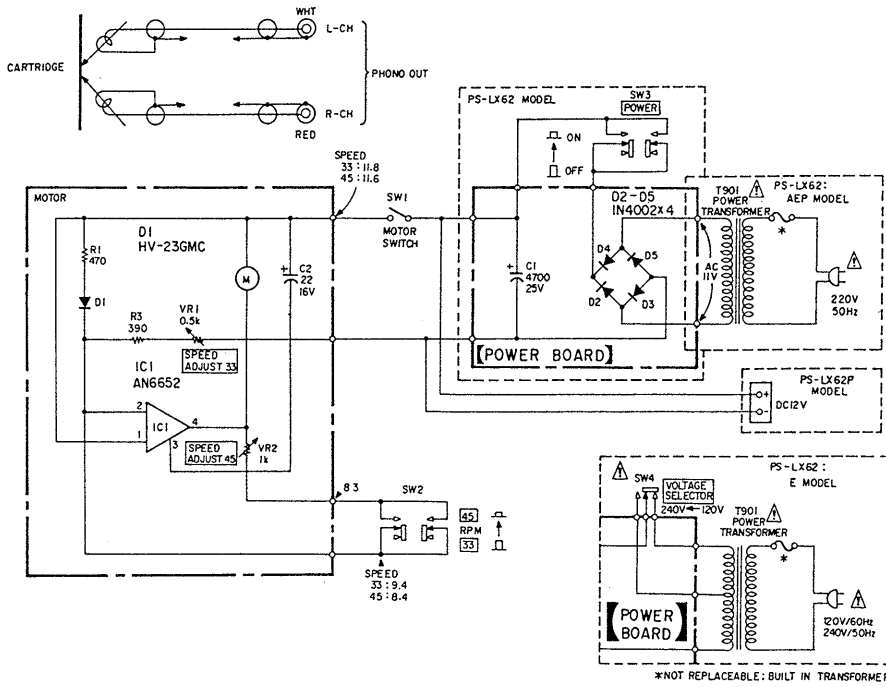

Note:

- All capacitors are in μF unless otherwise noted. $\text{pF} = \mu\text{F} / 100$. 50WV or less are not indicated except for electrolytics and tantalums.
- All resistors are in Ω and $1/4\text{W}$ or less unless otherwise specified.
- Switches:

Ref. No.	Switch	Position
SW1	MOTOR	OFF
SW2	SPEED	33
SW3	POWER	OFF
SW4	VOLTAGE SELECTOR	120V

Note:

The components identified by mark Δ or dotted line with mark Δ are critical for safety. Replace only with part number specified.

Note:

Les composants identifiés par une marque Δ sont critiques pour la sécurité. Ne les remplacer que par une pièce portant le numéro spécifié.

2-2. WIRING DIAGRAM

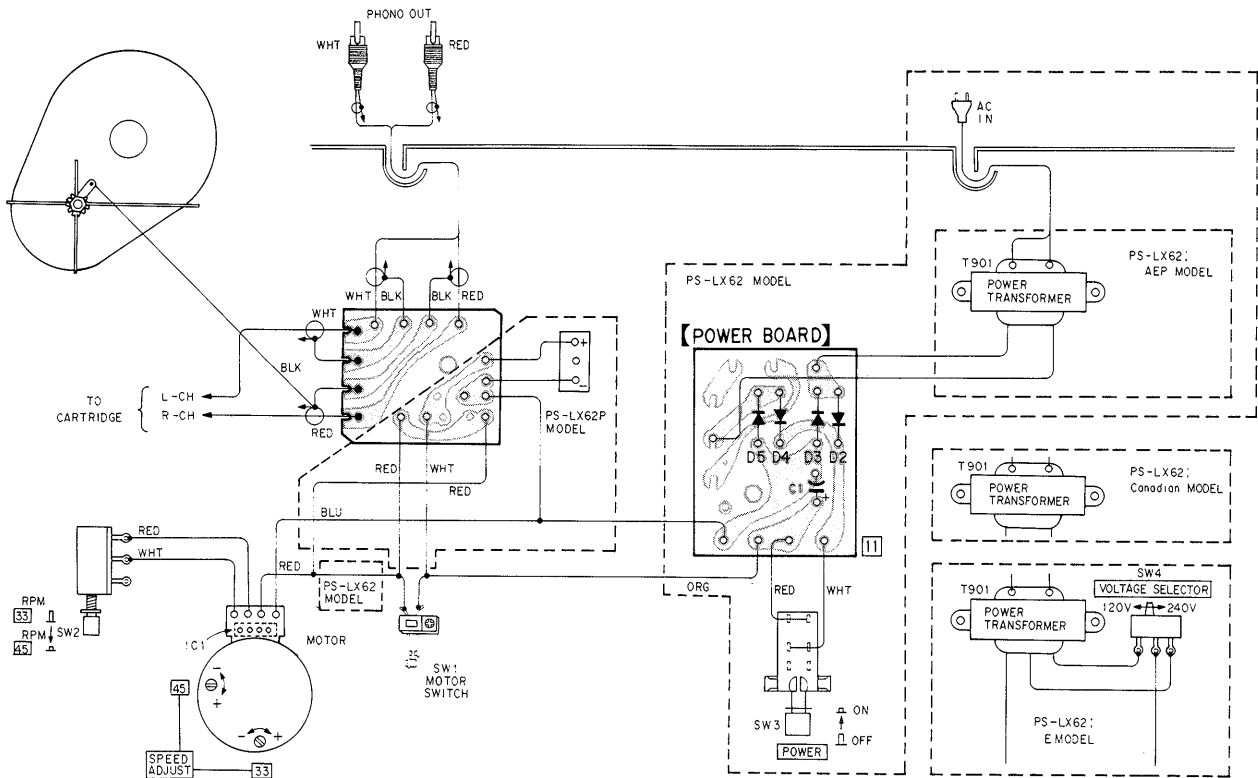

Note:

- Color code of sleeving over the end of the jacket:

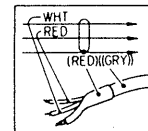

- \circ : parts extracted from the component side.

REVISED

(2)

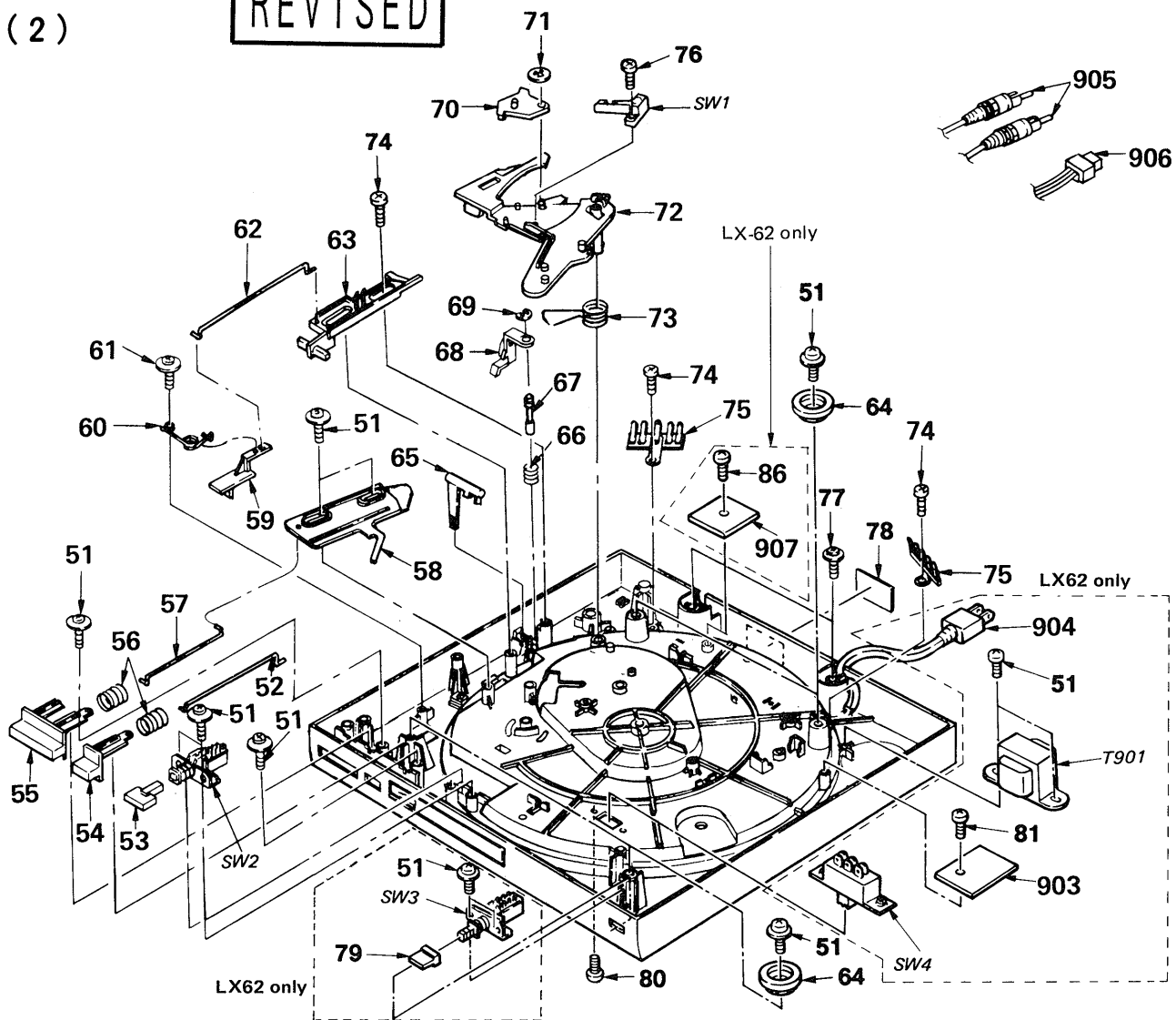

No.	Part No.	Description	Remarks	No.	Part No.	Description	Remarks
51	7-685-646-79	SCREW		78	4-896-343-01	(LX62:CANADIAN)	
52	4-896-261-01	WIRE, REJECT			4-896-344-01	... LABEL, MODEL NUMBER (LX62:AEP-BLACK)	
53	4-896-241-01	BUTTON, SPEED			4-896-344-11	... LABEL, MODEL NUMBER (LX62:AEP-WHITE)	
54	4-896-240-01	BUTTON, STOP			4-896-345-01	... LABEL, MODEL NUMBER (LX62:E)	
55	4-896-242-01	BUTTON, START			4-896-346-01	... LABEL, MODEL NUMBER (LX62P).. LABEL, MODEL NUMBER (LX62)...	
56	4-896-255-01	SPRING		79	4-895-896-01	... BUTTON, POWER	
57	4-896-216-01	WIRE, CONTROL ARM		80	7-621-775-20	2-BID 2605 ZN3A	
58	4-896-215-01	LEVER, CONTROL		81	7-685-647-79	SCREW P3x10	
59	4-896-243-01	KNOB, SPEED		903	1-626-640-11	(LX62)... PC BOARD, POWER	
60	4-896-244-01	SPRING		904	△ 1-555-795-00	(LX62:AEP) ... CORD, POWER, EULO PLUG (LX62:E, CANADIAN)	
61	4-896-245-01	SCREW (7-CUP 3008 ZN3A 10D)			△ 1-551-188-XX CORD, POWER (LX62P)	
62	*4-896-213-01	WIRE SELECTOR		905	1-555-116-11	CORD, CONNECTION (LX62P)	
63	4-896-214-01	SELECTOR, SIZE		906	1-558-596-11	... CORD, CONNECTION (3 CORE)	
64	4-895-435-01	FOOT		SW1	1-570-666-11	SWITCH, LEAF	
65	4-896-212-01	LEVER, CUE		SW2	1-571-089-11	SWITCH, PUSH (1 KEY)	
66	4-896-251-01	SPRING (B)		SW3	1-571-560-11	(LX62)... SWITCH, PUSH (1 KEY)	
67	4-896-252-01	SHAFT, ARM LIFT		SW4	△ 1-571-088-11	(LX62:E) ... SWITCH, SLIDE	
68	4-896-253-01	FORK, LIFT		T901	△ 1-449-291-11	(LX62:E, Saudi Arabia) ... TRANSFORMER, POWER	
69	4-896-254-01	RING (DIA. 3), E			△ 1-449-290-11	(LX62:AEP) ... TRANSFORMER, POWER	
70	4-896-248-01	CAM			△ 1-449-392-11	(LX62:CANADIAN) ... TRANSFORMER, POWER	
71	4-303-605-00	PUSH NUT DIA. 3					
72	4-896-218-01	ARM, CONTROL					
73	4-896-247-01	SPRING					
74	4-896-510-01	SCREW (7-BID 3014 ZN3A)					
75	*4-895-423-01	LUG TERMINAL					
76	7-685-104-19	SCREW (7-PAN 2006 ZN3A)					
77	4-896-256-01	SCREW ASSY					

SECTION 4

ELECTRICAL PARTS LIST

NOTE:

- Due to standardization, replacements in the parts list may be different from the parts specified in the diagrams or the components used on the set.
- Items marked "★" are not stocked since they are seldom required for routine service. Some delay should be anticipated when ordering these items.
- If there are two or more same circuits in a set such as a stereophonic machine, only typical circuit parts may be indicated and capacitors and resistors in other same circuits may be omitted.

CAPACITORS:
MF: μ F, PF: $\mu\mu$ F

RESISTORS



- All resistors are in ohms.
- F: nonflammable

COILS









- MMH: mH, UH: μ H

SEMICONDUCTORS

In each case, U: μ , for example:
UA...: μ A..., UPA...: μ PA...,
UPC...: μ PC, UPD...: μ PD...

The components identified by mark  or dotted line with mark  are critical for safety. Replace only with part number specified.

Les composants identifiés par une marque  sont critiques pour la sécurité. Ne les remplacer que par une pièce portant le numéro spécifié.

Ref. No.	Part No.	Description
901	1-541-568-11	MOTOR
902	1-549-135-11	CARTRIDGE
903	1-626-640-11	(LX62)... PC BOARD, POWER
904	 1-555-795-00	(LX62:AEP) ... CORD, POWER, EULO PLUG
	 1-551-188-XX	(LX62:E, CANADIAN) ... CORD, POWER
905	1-558-595-11	CORD, CONNECTION
906	1-558-596-11	(LX62P) ... CORD, CONNECTION (3 CORE)
C1	1-123-336-00	ELECT 470 20% 25V
D2	8-719-200-02	(LX62)... DIODE 10E2
D3	8-719-200-02	(LX62)... DIODE 10E2
D4	8-719-200-02	(LX62)... DIODE 10E2
D5	8-719-200-02	(LX62)... DIODE 10E2
SW1	1-570-666-11	SWITCH, LEAF
SW2	1-571-419-11	SWITCH, PUSH (1 KEY)
SW3	1-571-560-11	(LX62)... SWITCH, PUSH (1 KEY)
SW4	 1-571-088-11	(LX62:E) ... SWITCH, SLIDE
 T901	 1-449-291-11	(LX62:E) ... TRANSFORMER, POWER
	 1-449-290-11	(LX62:AEP) ... TRANSFORMER, POWER
	 1-449-392-11	(LX62:CANADIAN) ... TRANSFORMER, POWER

ACCESSORY & PACKING MATERIAL

Part No.	Description
3-701-806-00	ADAPTOR, 45
3-750-346-11 (LX62: AEP, E) MANUAL, INSTRUCTION
3-750-346-31 (LX62: CANADIAN) MANUAL, INSTRUCTION
3-750-346-41 (LX62: AEP, E) MANUAL, INSTRUCTION