

TASCAM

TEAC Professional Division

D00864010A

CD-01U / CD-01UPro

CD PLAYER

OWNER'S MANUAL

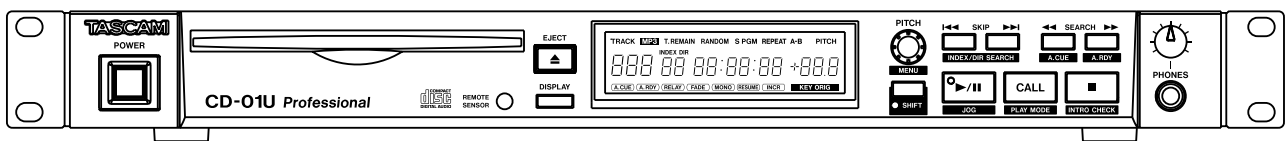

Important Safety Precautions



CAUTION: TO REDUCE THE RISK OF ELECTRIC SHOCK, DO NOT REMOVE COVER (OR BACK). NO USER-SERVICEABLE PARTS INSIDE. REFER SERVICING TO QUALIFIED SERVICE PERSONNEL.



The lightning flash with arrowhead symbol, within equilateral triangle, is intended to alert the user to the presence of uninsulated "dangerous voltage" within the product's enclosure that may be of sufficient magnitude to constitute a risk of electric shock to persons.



The exclamation point within an equilateral triangle is intended to alert the user to the presence of important operating and maintenance (servicing) instructions in the literature accompanying the appliance.

This appliance has a serial number located on the rear panel. Please record the model number and serial number and retain them for your records.

Model number _____
Serial number _____

WARNING: TO PREVENT FIRE OR SHOCK HAZARD, DO NOT EXPOSE THIS APPLIANCE TO RAIN OR MOISTURE.

For U.S.A.

TO THE USER

This equipment has been tested and found to comply with the limits for a Class A digital device, pursuant to Part 15 of the FCC Rules. These limits are designed to provide reasonable protection against harmful interference when the equipment is operated in a commercial environment. This equipment generates, uses, and can radiate radio frequency energy and, if not installed and used in accordance with the instruction manual, may cause harmful interference to radio communications.

Operation of this equipment in a residential area is likely to cause harmful interference in which case the user will be required to correct the interference at his own expense.

CAUTION

Changes or modifications to this equipment not expressly approved by TEAC CORPORATION for compliance could void the user's authority to operate this equipment.

For the customers in Europe

WARNING

This is a Class A product. In a domestic environment, this product may cause radio interference in which case the user may be required to take adequate measures.

Pour les utilisateurs en Europe

AVERTISSEMENT

Il s'agit d'un produit de Classe A. Dans un environnement domestique, cet appareil peut provoquer des interférences radio, dans ce cas l'utilisateur peut être amené à prendre des mesures appropriées.

Für Kunden in Europa

Warnung

Dies ist eine Einrichtung, welche die Funk-Entstörung nach Klasse A besitzt. Diese Einrichtung kann im Wohnbereich Funkstörungen verursachen; in diesem Fall kann vom Betreiber verlangt werden, angemessene Maßnahmen durchzuführen und dafür aufzukommen.

CE Marking Information

- a) Applicable electromagnetic environment: E4
- b) Peak inrush current: 5.2 A

Important Safety Instructions

- 1 Read these instructions.
 - 2 Keep these instructions.
 - 3 Heed all warnings.
 - 4 Follow all instructions.
 - 5 Do not use this apparatus near water.
 - 6 Clean only with dry cloth.
 - 7 Do not block any ventilation openings. Install in accordance with the manufacturer's instructions.
 - 8 Do not install near any heat sources such as radiators, heat registers, stoves, or other apparatus (including amplifiers) that produce heat.
 - 9 Do not defeat the safety purpose of the polarized or grounding-type plug. A polarized plug has two blades with one wider than the other. A grounding type plug has two blades and a third grounding prong. The wide blade or the third prong are provided for your safety. If the provided plug does not fit into your outlet, consult an electrician for replacement of the obsolete outlet.
 - 10 Protect the power cord from being walked on or pinched particularly at plugs, convenience receptacles, and the point where they exit from the apparatus.
 - 11 Only use attachments/accessories specified by the manufacturer.
 - 12 Use only with the cart, stand, tripod, bracket, or table specified by the manufacturer, or sold with the apparatus. When a cart is used, use caution when moving the cart/apparatus combination to avoid injury from tip-over.
- Do not expose this apparatus to drips or splashes.
 - Do not place any objects filled with liquids, such as vases, on the apparatus.
 - Do not install this apparatus in a confined space such as a book case or similar unit.
 - The apparatus draws nominal non-operating power from the AC outlet with its POWER switch in the off position.
 - The apparatus should be located close enough to the AC outlet so that you can easily grasp the power cord plug at any time.
 - An apparatus with Class I construction shall be connected to an AC outlet with a protective grounding connection.



- 13 Unplug this apparatus during lightning storms or when unused for long periods of time.
- 14 Refer all servicing to qualified service personnel. Servicing is required when the apparatus has been damaged in any way, such as power-supply cord or plug is damaged, liquid has been spilled or objects have fallen into the apparatus, the apparatus has been exposed to rain or moisture, does not operate normally, or has been dropped.

Safety Information

This product has been designed and manufactured according to FDA regulations "title 21, CFR, chapter 1, subchapter J, based on the Radiation Control for Health and Safety Act of 1968", and is classified as a class 1 laser product. There is no hazardous invisible laser radiation during operation because invisible laser radiation emitted inside of this product is completely confined in the protective housings. The label required in this regulation is shown ①.

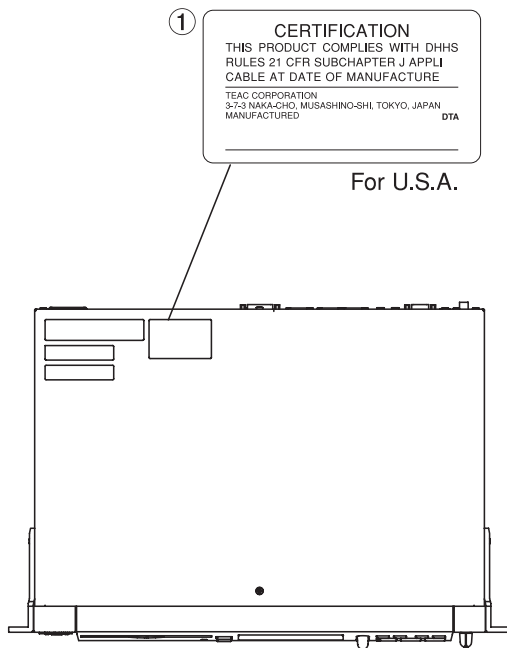

CAUTION

- DO NOT REMOVE THE PROTECTIVE HOUSING USING A SCREWDRIVER.
- USE OF CONTROLS OR ADJUSTMENTS OR PERFORMANCE OF PROCEDURES OTHER THAN THOSE SPECIFIED HEREIN MAY RESULT IN HAZARDOUS RADIATION EXPOSURE.
- IF THIS PRODUCT DEVELOPS TROUBLE, CONTACT YOUR NEAREST QUALIFIED SERVICE PERSONNEL, AND DO NOT USE THE PRODUCT IN ITS DAMAGED STATE.

Optical pickup:

Type: KSM-900AAA
Manufacturer: SONY Corporation
Laser output: Less than 0.5 mW on the objective lens
Wavelength: 775 to 815 nm

Table of contents

1 - Introduction	
Supplied accessories	6
Environmental considerations	6
Some notes and precautions	6
Beware of condensation	6
Back up memory	6
Rack - mounting the unit	7
Handling of compact discs	7
2 - Remote control unit	
Some notes and precautions	8
Batteries	8
Inserting batteries	8
3 - Connections	
Audio equipment	9
Connecting analog audio equipment	9
Connecting digital audio equipment	9
Power source	9
4 - Features and their functions	
Front panel	10
Display	11
Rear Panel	12
Remote Control Unit	12
5 - Menu operation	
Menu configuration	14
Menu operation	14
Operation basics	14
6 - Playback	
Discs for playback	15
About finalization	15
For MP3 CDs	15
Playback modes	16
Basic playback operation	16
Using headphones	16
Track selection	16
Selecting by track number	17
Search	17
Frame search	17
7 - Advanced operations	
Auto Cue	18
Auto Ready	18
Resume	18
Call	18
Incremental play	19
Repeat playback	19
A to B repeat playback	19
Intro check	20
Output in monaural	20
Power on play	20
Pitch control	20
Changing the playback speed without changing the key (Key original)	21
Program playback	21
Editing a programmed track	21
Adding a track to the program	21
Deleting a programmed track	22
Fade in and fade out	22
Relay play	22
Time display switching	23
End of disc/track warning	23
Eject block	23
Fader start/Event start	23
Fader start/stop	23
Event start	24
Restoring factory default settings	24
External parallel control	24
8 - Specifications	
Specifications	25
Dimensional drawing	26
Error Messages	26

1 - Introduction — Environmental considerations

Thank you for your purchase of the TASCAM CD-01U/CD-01U Pro CD player.

Before connecting and using the unit, please take time to read this manual thoroughly to ensure you understand how to properly set up and connect the

CD-01U/CD-01U Pro, as well as the operation of its many useful and convenient functions. After you have finished reading this manual, please keep it in a safe place for future reference.

Supplied accessories

In addition to this manual, the CD-01U/CD-01U Pro have been packed with the following:

- RC-01UC remote control unit
- 2 AAA batteries
- Power cord
- Rack-mounting kit
- Warranty document

Should any of these items be missing, or if you encounter any damage, please contact your TASCAM supplier.

This unit was packed in its carton with special materials in order to prevent any damage during shipment.

Please save the carton and packing materials in the event you need to transport the unit in the future.

Environmental considerations

The CD-01U/CD-01U Pro may be used in most places, but to maintain top performance and prolong operating life, do not place it in the following locations.

- On an unsteady surface, or where there is frequent vibration or resonance
- Near a window or where it can be exposed to direct sunlight

- Near heating or air conditioning vents, or in very hot or cold places
- Places with high humidity or poor ventilation
- Next to tuners, televisions or video decks, as this could cause noise or affect video images

Some notes and precautions

Connect the CD-01U/CD-01U Pro only to the specified power source.

When unplugging the cord, grasp the plug itself.

Clean only with a dry cloth. Do not use benzene, paint thinner or other agents that could damage the surface. Dust or grime on the top cover can be removed with a soft cloth lightly moistened with a diluted mild detergent solution.

Beware of condensation

If the unit is moved from a cold to a warm place, or used after a sudden temperature change, condensation inside the unit may occur, resulting in moisture on the internal mechanism or an inserted disc, thus impairing proper operation.

Should this occur, leave the player turned on for one or two hours so that the condensation can evaporate before you begin operation.

Also, please remove all discs from the unit if it will be moved, or not operated for an extended period of time.

Backup Memory

Even when the power is turned off, the following settings are retained.

- Playback mode
- Time display mode
- Auto ready ON/OFF
- Auto cue ON/OFF
- Pitch control value
- All menu settings

1 - Introduction — Environmental considerations

Rack-mounting the unit

Use the rack-mounting kit to mount the unit in a standard 19-inch equipment rack, as shown below.

Remove the feet of the unit before mounting.

If you are mounting the unit in a rack, leave 1U of space above it and 10cm (4 in) or more of space at the rear. The CD-01U/CD-01U Pro can be mounted in any angle between 0 to 90 degrees.

See Environmental considerations on the previous page.

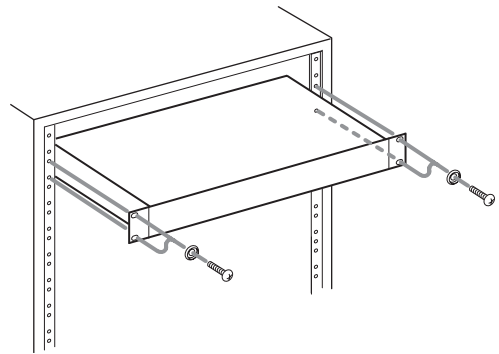

Handling of compact discs

The CD-01U/CD-01U Pro have been designed for the playback of CD-DA format discs and MP3 files recorded in ISO9660 format. In addition to ordinary 5-inch and 3-inch CDs, it can also play properly recorded CD-R and CD-RW discs.

When removing a CD from its case, press down on the center of the disc holder to free the CD, then lift the disc out, holding it carefully by the edges.

- Removing a disc

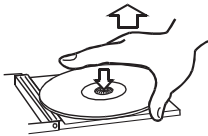

- Hold the CD like this



- Avoid getting fingerprints on the signal side (opposite the label side). When cleaning, wipe gently with a soft cloth from the center towards the outside edge. Dust and grime may cause skipping, so keep discs clean and store them in their cases when not being played.



- Do not use any record spray, anti-static solutions, benzene, paint thinner or other chemical agents to clean CDs as they could damage the delicate playing surface.
- Discs should be returned to their cases after use to avoid serious scratches that could cause the laser pickup to skip.

- Keep discs away from direct sunlight, and places of high heat and humidity. If left in such places, warping could result.
- Do not affix any labels or stickers to the label side of the disc. Do not write on the disc with a ballpoint pen.
- Please do not insert discs that have adhesive remaining from tape or stickers that have been removed. If they are inserted into the player, they could stick to the internal mechanism, requiring removal by a technician.

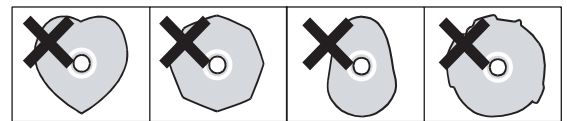

- Only use circular compact discs. Avoid using non-circular promotional, etc. discs.
- The CD-01U/CD-01U Pro cannot play unfinalized CD-R/RW discs.
- Do not use a C-thru disc.

The unit does not support a C-thru disc. Therefore, you may not be able to insert a C-thru disc or may not be able to remove a C-thru disc that has been successfully inserted to the unit.

In the latter case, try to press the DISPLAY and EJECT keys simultaneously, which may solve the problem.

- Do not use the DualDisc. DualDisc is two-sided playback only discs. Insertion or ejection of a DualDisc into/from CD-01U/CD-01U Pro is likely to cause scratches to the surface of the DualDisc. Scratched discs may not play in CD products.

A DualDisc may not play in CD-01U/CD-01U Pro and a DualDisc could get stuck in and may not be able to be removed from the CD-01U/CD-01U Pro.

2 - Remote control unit

Some notes and precautions

- When the remote control will not be used for an extended period of time, please remove the batteries to prevent the possibility of battery acid leakage which could damage the unit.
Should leakage occur, remove and discard the batteries, and wipe the battery case thoroughly with a cloth.
Avoid getting the battery liquid on the skin. After cleaning, replace with new batteries.
- The remote control functions by using an infrared light signal. When using the unit to control the CD-01U/CD-01U Pro, other devices that are turned on could be operated by its signal.
- If the range of remote operation becomes smaller, or commands do not always function properly, the batteries have become weak and should be replaced. Always replace both batteries with new batteries of the same type.
- Point the remote control to the remote sensor on the main unit.
Do not obstruct the path between the remote control and the remote sensor.

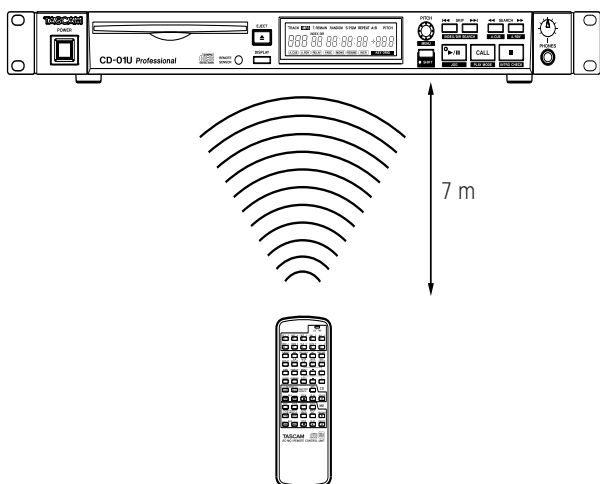

Batteries

If batteries are used improperly, or if leakage or breakage occurs, the unit will not function.

Please observe the cautions indicated on the batteries and their packaging to ensure proper usage.

- Confirm + and - polarity and follow the indications when inserting new batteries into the remote control.
- Do not use old and new batteries together.
- Even if the battery is the same size, the voltage may differ.
Do not use batteries of different specifications together.
- Do not attempt to recharge batteries that are non-rechargeable.
- Do not open or disassemble batteries, throw them into a fire or put them in water.

Inserting batteries

1. Open the lid.
2. Confirm +/- polarity, and insert two AAA batteries.
3. Close the lid.

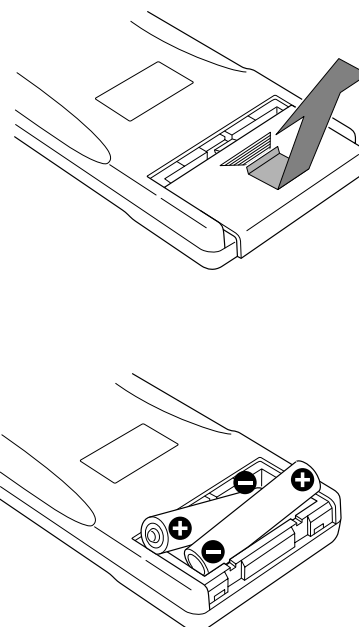

3 - Connections

Before connecting the CD-01U/CD-01U Pro to other units, please read their operation manuals thoroughly to ensure proper connection. Turn the power on only after all connections have been made.

Audio equipment

Connecting analog audio equipment

Connect analog stereo amplifiers, mixers and recorders to the analog line outputs.

NOTE

- Connection cables are not supplied with this unit.
- Do not bundle the pin connection cords with the power cord as noise or diminished sound quality could result.

Connecting digital audio equipment

Digital stereo amplifiers, mixers and recorders can be connected through the optical digital output terminal.

Power source

This unit has been designed to operate on the specified power voltage only.
Do not plug the power cord into outlets of any other voltage.

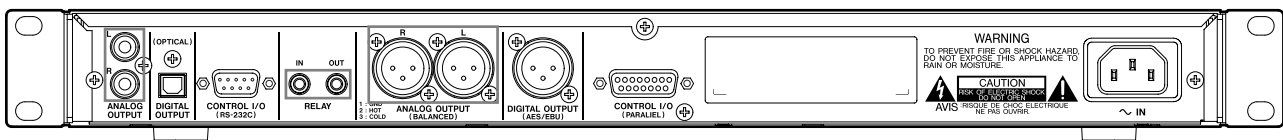

4 - Features and their functions

Front panel

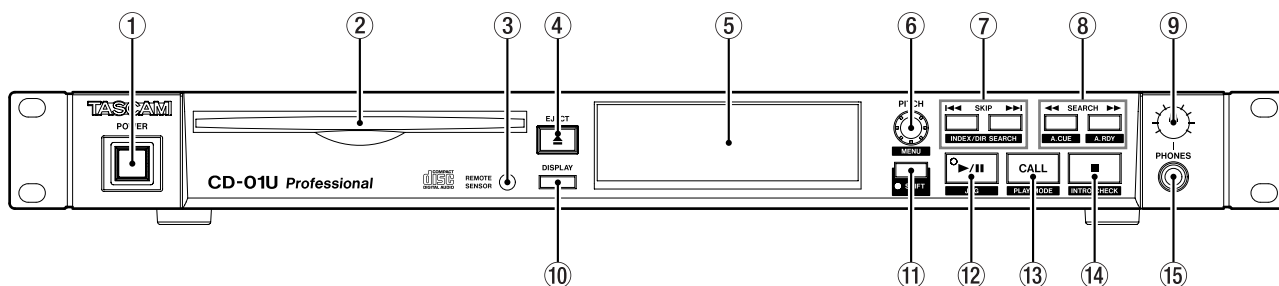

① POWER switch

② Disc slot

Insert CD into the slot, label side upwards.

③ Remote signal sensor

④ EJECT key

Ejects a disc. This key cannot be used when Eject Block is on and disc is being played back.

⑤ Display

The display is used to show the current status of the unit, as well as the current menu settings.

⑥ PITCH (MENU) control knob

Push this control to turn the pitch control function on or off. When it is on, pitch value is shown on the Display, and pitch can be controlled +/- 12.5%. Even when the power is turned off, the pitch control ON/OFF setting is retained.

When in shift mode, functions as the menu dial when rotated, and as the **ENTER** key when pushed.

When playback is paused and **SHIFT** indicator is lit, frame accurate search can be performed using with this knob.

⑦ SKIP (INDEX/DIR SEARCH) keys

Use these to perform track searches.

When **SHIFT** indicator is lit, searches the index (Audio CD discs) or directory (MP3 discs).

⑧ SEARCH (A.CUE, A.RDY) keys

Performs review or cue playback (search).

When in shift mode, selects the Auto Cue level or turns the Auto Ready mode on and off.

⑨ PHONES level control

Adjusts the headphone output level.

⑩ DISPLAY key

Pressing this key changes the time mode on the display. Even when the power is turned off, the time mode is retained.

When in menu mode, exits the menu mode.

⑪ SHIFT key and indicator

Turns the shift mode on and off. When in shift mode, the indicator lights and other keys have shift functions which indicated under the keys.

Pressing this key again exits shift mode.

⑫ ►/|| (JOG) key and indicator

Changes the playback mode between playback and pause.

The indicator stays on solid in playback mode and flashes in pause mode.

When playback is paused and **SHIFT** indicator is lit, frame accurate search can be performed using with the **PITCH** knob.

⑬ CALL (PLAY MODE) key

Locates the playback to the last play start point.

When **SHIFT** indicator is lit, selects the playback mode.

⑭ ■ (INTRO CHECK) key

Use this key to stop playback.

When Incremental Play is activated, pressing this key pauses at the beginning of next track.

When in shift mode, enters Intro Check mode.

⑮ PHONES jack

Use a standard pair of stereo headphones, equipped with a 1/4-inch plug, with this jack.

4 - Features and their functions

Display

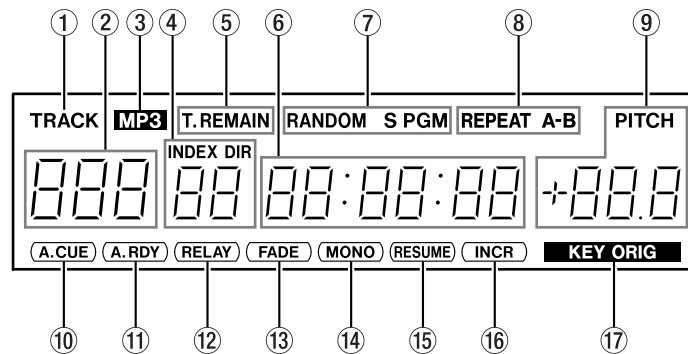

① TRACK indicator

② Track number display

Shows the track number. In the menu mode, shows the menu number.

③ MP3 indicator

Lights when a MP3 CD-ROM disc is inserted.

④ INDEX/DIR indicator

Shows the index number (CD-DA) or directory number (MP3).

⑤ T and REMAIN indicators

When the time mode is set to remain time mode, these indicators light.

Total remain mode: Both **T** and **REMAIN** indicators light.

Track remain mode: **REMAIN** indicator lights.

⑥ Time display

This section is used to show time values, menu information or messages.

ABCDEFGHIJKLMNOPQRSTUVWXYZ
abcdefghijklmnopqrstuvwxyz

⑦ Play mode indicators

Indicates the current playback mode.

RANDOM: Random playback mode

S: Single playback mode

PGM: Programmed playback mode

⑧ REPEAT indicators

Indicates the current repeat mode.

⑨ PITCH indicator and pitch value display

When pitch control is activated, shows the pitch value and **PITCH** indicator lights.

In the menu mode, shows the menu parameters.

⑩ A.CUE indicator

Lights when Auto Cue function is turned on.

⑪ A.RDY indicator

Lights when Auto Ready function is activated.

⑫ RELAY indicator

Lights when Relay Play mode is activated.

⑬ FADE indicator

Lights when Fade in/out is turned on.

⑭ MONO indicator

Lights when in Mono output mode.

⑮ RESUME indicator

Lights when Resume mode is on.

⑯ INCR indicator

Lights when Incremental Play is activated.

⑰ KEY ORIGINAL indicator

Lights when Key Original function is turned on.

4 - Features and their functions

Rear panel

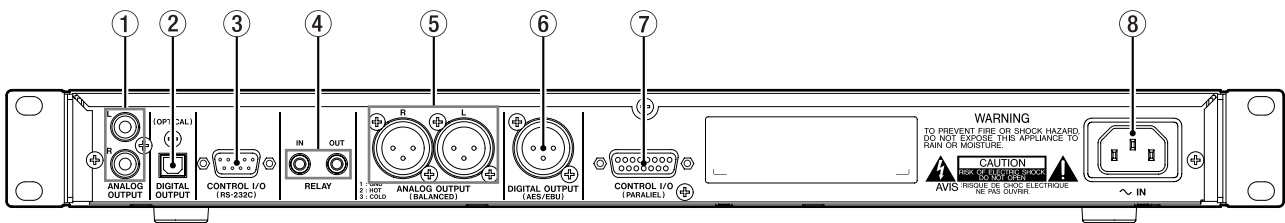

① ANALOG OUTPUT terminals

The analog line output terminals are for RCA pin jacks. The maximum output level is +6 dBV.

② DIGITAL (OPTICAL) OUTPUT terminal

Provides the digital audio signal in S/PDIF format. This connector outputs the 44.1KHz digital signals constantly even if pitch control is activated.

③ CONTROL I/O (RS-232C) connector

This RS-232C interface allows control by a computer or by other serial controllers. Consult your TASCAM dealer the TASCAM web site for details of this port if you wish to use it.

④ RELAY IN/OUT jacks

These jacks are used to perform the relay play operation between two or more CD-01U/CD-01U Pro, or perform the fader start or event start operation.

⑤ ANALOG OUTPUT (BALANCED) terminals (CD-01U Pro only)

The analog line output terminals are for XLR connectors. The maximum output level is +20 dBu.

⑥ DIGITAL (AES/EBU) OUTPUT terminal (CD-01U Pro only)

Provides the digital audio signal in AES/EBU format. This connector outputs the 44.1KHz digital signals constantly even if both control is activated.

⑦ CONTROL I/O (PARALLEL) connector (CD-01U Pro only)

Parallel control from an external devices can be performed.

⑧ ~ IN

Connect the power cable supplied with the CD-01U/CD-01U Pro.

Remote Control Unit

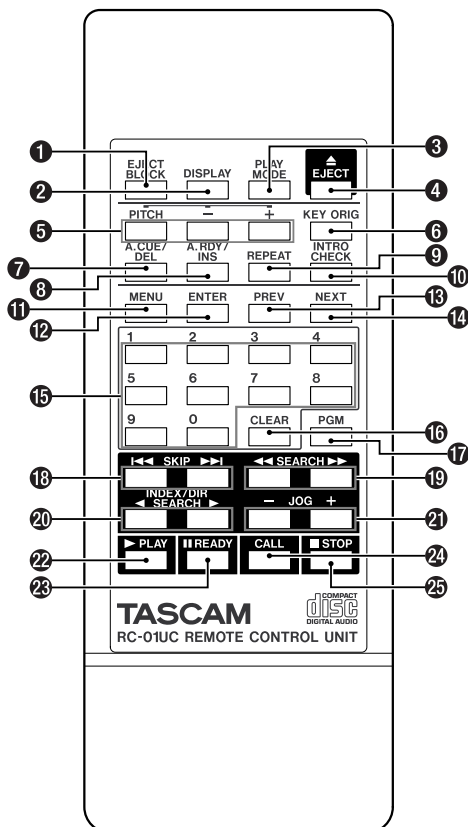

① EJECT BLOCK key

This turns the Eject Block mode on and off.

② DISPLAY key

Pressing this key changes the time mode on the display.

③ PLAY MODE key

This selects the playback mode. During selection, the playback mode is indicated on the display in the following manner.

Normal playback (in disc order): no indication

Single playback: **S** lights up

Program playback: **PGM** lights up

Random playback: **RANDOM** lights up

④ EJECT key

Press this to eject the disc. This key cannot be used when Eject Block mode is on and the disc is being played back.

4 - Features and their functions

5 PITCH key +/- keys

Use these keys to perform the pitch control function.

6 KEY ORIG key

This turns the Key Original function on and off.

7 A.CUE/DEL key

Sets the Auto Cue level.

During program input, the selected program number track is deleted.

8 A.RDY/INS key

Turns the Auto Ready function on and off.

During program input, inserts a track into the program list.

9 REPEAT key

Turns the Repeat Play mode on and off.

Pressing and holding this key for one second or more enters the Repeat A-B mode.

10 INTRO CHECK key

Enters the Intro Check mode.

11 MENU key

Enters the Menu mode.

12 ENTER key

Confirms the menu options and confirms the settings and editing on the menu.

13 PREV key

Selects the previous menu option or setting on the menu.

14 NEXT key

Selects the next menu option or setting on the menu.

15 Number keys

These are used to select track numbers.

16 CLEAR key

During track number input, the track number is cleared when this key is pressed.

17 PGM key

Pressing this key enters the Program mode.

18 SKIP keys

Use these keys to skip to the previous track or the next track.

19 SEARCH keys

During playback or playback standby, press the key continuously for review or cue playback (search).

20 INDEX/DIR SEARCH key

Use this key to select the index (Audio CDs) or directory (MP3 discs).

21 JOG +/- keys

Pressing the key in pause mode performs the frame accurate search.

22 ► PLAY key

Press this key to start CD playback.

When incremental play function is activated, pressing this key play start from the next track.

23 || READY key

When this key is pressed during playback or while stopped, enters standby mode.

24 CALL key

Locates the playback to the last play start point.

25 ■ STOP key

Use this key to stop playback.

When incremental play function is activated, pressing this key pauses at the beginning of the next track.

5 - Menu operation

The various settings and editing operations possible with the CD-01U/CD-01U Pro are performed through menu options shown on the display. Among the many

menu setting options, some may be made directly using the keys on the remote control.

No.	Menu	Function	Parameter <small>Underlined values are factory default settings</small>	Manual reference	Page
01	KEY-0	Key Original	ON, <u>OFF</u>	Key Original	21
02	BLOCK	Eject Block	<u>ON</u> , OFF	Eject Block	23
03	REPEAT	Repeat Playback A-B Repeat Playback	<u>OFF</u> , ON, A-B	Repeat Playback	19 19
04	PROG	Program	rogram operation	Program Playback	21
05	FADE	Fade In/Out	<u>OFF</u> , 0.5-10.0	Fade In/Out	22
06	RELAY	Relay Playback Fader/Event Start	<u>OFF</u> , ON, FDR	Relay Play 23	21
07	TIMER	Power on Play	ON, <u>OFF</u>	Power on play	20
08	MONO	Mono Output	ON, <u>OFF</u>	Output in Mono	20
09	RESUME	Resume	ON, <u>OFF</u>	Resume	18
10	EOM	EOM Time 25, <u>30</u> , 35 sec.	OFF, 5, 10, 15, 20,	EOM	23
11	INCR	Incremental Play	ON, <u>OFF</u>	Incremental Play	19
12	PITCH	Pitch Step	0.1, 0.5, 1.0 %	Pitch Control	20
13	RS232C	Baud rate setting	96, 192, 384		
14	F-PRE	Factory Preset	(SURE)	Restoring the default setting	24
15	U-DATA	User Data	<u>ON</u> , OFF	**	

** When digital output signal from the AES/EBU terminal is not received correctly on the other digital equipment , set the user data to OFF then try again.

Operation basics

1 Press the **PITCH** knob on the front panel when SHIFT indicator is lit or press the **MENU** key on the remote control.

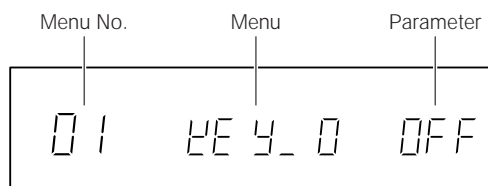

2 Use the **PITCH** knob on the front panel, or **PREV/NEXT** keys or number keys on the remote control to select the menu item.

3 Press the **PITCH** knob on the front panel or **ENTER** key on the remote control.

4 Use the **PITCH** knob on the front panel or **PREV/NEXT** keys on the remote control to select the setting value.

5 Press the **PITCH** knob on the front panel or **ENTER** key on the remote control.

NOTE

Pressing the **DISPLAY** key on either the front panel or the remote control exits the menu mode.

6 - Playback

Discs for playback

The CD-01U/ CD-01U Pro can playback the types of discs listed below.

- Ordinary audio CDs available commercially (recorded in CD-DA format).
- CD-R and CD-RW discs recorded in CD-DA format, and properly finalized.

- MP3 files recorded in ISO9660 format on CD-R and CD-RW discs, and properly finalized.
- CD-R/RW discs that have not been finalized cannot be played back. Make sure the disc has been properly finalized before loading into the player.

About finalization

Even if audio data is recorded onto a CD-R/RW disc, if the TOC (table of contents corresponding to the recorded data) is not written on the disc after recording, the disc cannot be played back on conventional CD players. Finalization is the process of writing the TOC on the disc.

A number of record companies have released titles on

copy control CD discs as a means of protecting artist copyrights. Some of these discs do not comply with standard CD format specifications, and may not be able to be played on this unit.

The CD-01U/CD-01U Pro can play back MP3 files recorded in formats which conform to ISO9660 level 1, level 2 and Joliet.

For MP3 CDs

CDs containing MP3 files can be played by the CD-01U/CD-01U Pro with the following limitations on the number of files and directories.

Maximum number of directories: 254

Maximum number of MP3 files: 255

File format: MPEG 1 audio layer 3

Bit rate: 32kbps to 320kbps

Sampling frequency: 44.1KHz, Stereo

File extension: mp3, Mp3, mP3, MP3

NOTE

The CD-01U/CD-01U Pro can only read the files in the first session of a multi-session disc.

NOTE

ID3 tag display for MP3 playback is not supported.

MP3 files are played as the order in the following diagram.

In this manner, playback is performed from the top level directories.

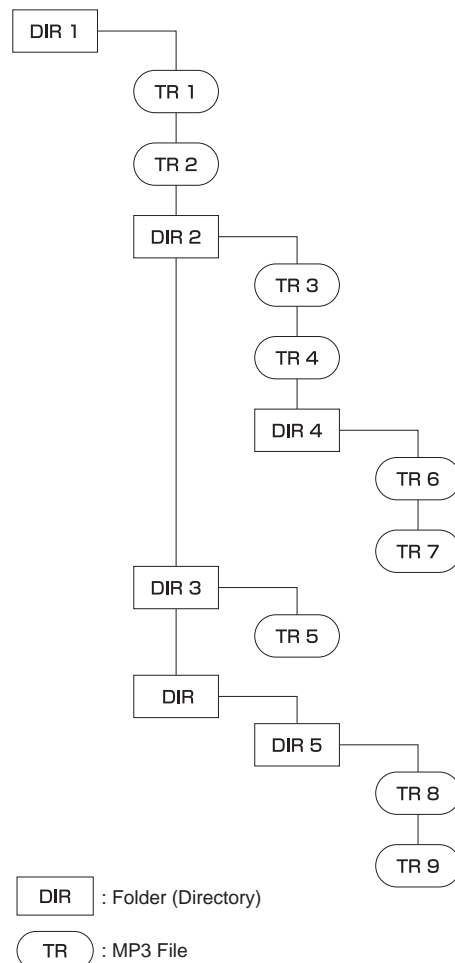

6 - Playback

Playback modes

There are four different playback modes. The mode selected is indicated on the display.

Normal (continuous) playback mode: no indication lamp

Single playback mode: **S** is lit

Program playback mode: **PGM** is lit

Random playback mode: **RANDOM** is lit

The playback mode can be selected using the **PLAY MODE** key on the remote control. Pressing the key

changes the playback mode in the following order:

Cont → Single → Program → Random

You can also select the playback mode pressing the **CALL/PLAY MODE** key on the front panel when in **SHIFT** mode.

While the mode can be changed from any playback mode, the explanation in this manual will assume the user is starting from the normal Continuous mode.

Basic playback operation

1 Push the **POWER** switch to turn on the unit.

The display will indicate NO DISC.

2 Insert a disc into the slot, label side upwards.

After a disc is inserted, the total playing time and number of tracks will be displayed.

NOTE

Do not force the disc into the slot, the CD-01U/CD-01U Pro will pull the disc when partially inserted.

3 Press the **▶/||** key on the front panel or **▶** key on the remote control unit.

The play indication will light up, and playback begins from track 1. The number of the current track in play is indicated on the display.

To stop playback, press the **■** key on the front panel or remote control unit.

To pause playback, press the **▶/||** key on the front panel again or **||** key on the remote control unit.

The indication will blink, and the unit will enter play-

back standby mode.

To resume playback, press the **▶/||** key or the front panel or **▶** key on the remote control.

To remove the disc

Press the **EJECT** key on either the front panel or remote control unit.

NOTE

You can insert back a disc into the slot by pressing the **EJECT** key or pull the disc and slot it in again.

NOTE

When Eject Block is activated, **EJECT** key cannot be used when disc is being played back.

To play a desired track

Press the **SKIP** key to select the desired track or numerical keys.

Using headphones

Plug the headphone cord into the PHONES jack.

Adjust the volume with the volume control.

WARNING

When using headphones, take care not to turn the vol-

ume too high. Listening at high volumes for extended periods of time may result in permanent hearing damage.

Track selection

Select desired tracks for playback with the skip keys on the front panel or on the remote control.

To restart playback from the beginning of the track in play, press the **◀◀** once.

To skip to the previous track, press **◀◀** twice.

To skip to the next track, press **▶▶** once.

When Auto Cue is off and the CD-01U/CD-01U Pro is in stop or play mode, playback begins after selecting the track.

When Auto Cue is off and the CD-01U/CD-01U Pro is in pause mode, the beginning of selected track is located, and the unit enters playback standby mode.

When Auto Cue is on and the CD-01U/CD-01U Pro is in play mode, playback begins after selecting the track.

When Auto Cue is on and the CD-01U/CD-01U Pro is in pause or stop mode, when a track is selected, the point where sound begins (not where the track begins) on that track is located, and the unit enters playback standby mode.

6 - Playback

Selecting by track number

Using the number keys on the remote control, the number of the desired track can be entered directly.

Even numbers with two (Audio CD) or three (MP3) digits can be entered easily.

For example:

Track 9 (Audio CD): press 0 then press 9.

Track 9 (MP3): press 0, 0, and 9.

Search

During playback or playback standby, pressing the **SEARCH** keys continuously enables the search of a desired portion within a track for playback.

NOTE

The search function does not operate with MP3 discs.

Frame search

During playback standby, using the **PITCH** knob in shift mode performs the frame accurate search.

Also, during playback standby, pressing the **JOG +/-** keys on the remote control performs the frame search.

NOTE

This function does not operate with MP3 discs.

7 - Advanced operations

Auto Cue

When the Auto Cue function is turned on and a track is selected, the point where sound begins (not where the track begins) on that track is located to and the unit enters pause mode.

When the ► key is pressed, playback begins at exactly that point.

NOTE

Auto Cue is not supported for MP3 playback.

NOTE

During stop mode, to cue to the start of sound on track one, just press the ■ key.

Auto Ready

When the Auto Ready function is on, after each track is played, playback standby mode is entered at the beginning of the next track.

The behavior of Auto Ready function is follows.

Continuous play mode:

Pause the beginning of the next track when playback of the current track is finished.

Single play mode:

Pause the beginning of the current track when playback of the current track is finished.

Program play mode:

Pause the beginning of the next programmed track when playback of the current track is finished.

Turning the Auto Cue function on and off

Press the ◀◀ key on the front panel when **SHIFT** indicator is lit or **A.CUE/DEL** key on the remote control to select the auto cue level.

Auto cue level: OFF (default), -24, -30, -36, -42, -48, -54, -60, -66, -72 (dB)

When the Auto Cue function is activated, **A.CUE** indicator is lit on the display.

Even when the power is turned off, the Auto Cue setting is maintained.

NOTE

When the Auto Cue function is also on, playback standby mode is entered at the beginning of the sound on the selected track, and not the beginning of that track.

Turning the Auto Ready function on and off

Press the ▶▶ key on the front panel when **SHIFT** indicator is lit or **A.RDY/INS** key on the remote control to turn the function on and off.

When the Auto Ready function is on, **A.RDY** indicator is lit on the display.

Even when the power is turned off, the Auto Ready setting is maintained.

Resume

When the resume function is on, the playback stop position is memorized and playback starts from that position when playback is resumed.

NOTE

In the case of MP3 discs, the playback starts from the beginning of the last playing track when playback is resumed.

Turning the Resume function on and off

Set the resume function on and off on the menu (menu

number 09 RESUME).

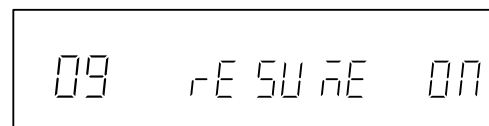

When the Resume function is on, **RESUME** indicator is lit on the display.

Even when the power is turned off, this setting is maintained.

Call

Pressing the **CALL** key on either the front panel or remote control locates the unit to last play start point, and the unit enters playback standby mode.

NOTE

This function is not supported for MP3 playback.

7 - Advanced operations

Incremental play

This function allows auto-cueing of the playback point to the start of the next track when the ■ key on either the front panel or remote control is pressed, or a stop command is received from the external device.

NOTE

Pressing the ■ key again or receiving the stop command again, unit enters stop mode.

When this mode is enabled, pressing the ► key on the remote control or receiving the play command from the external device starts playback from the beginning of the track following the current track.

Turning the Incremental play function on and off

Set the incremental play function on and off on the menu (menu number 11 INCR).



When the this function is on, **INCR** indicator is lit on the display.

Even when the power is turned off, this setting is maintained.

Repeat playback

Press the **REPEAT** key on the remote control to turn on the repeat mode. In this mode, all the tracks on the disc are played continuously.

During playback, if the repeat mode is turned on, playback continues as before, and when the last track finishes, playback resumes from the first track. If repeat mode is turned on when the deck is stopped, press the **PLAY** key to begin operation.

Combining the repeat mode with the Program, Single-track playback and Random playback functions will

enable Program Repeat, Single-track Repeat and Random Repeat operations, respectively.

Turning the Repeat play function on and off

Turn the repeat play function on and off on the menu (menu number 03 REPEAT). Or press the **REPEAT** key on the remote control.

When the this function is on, **REPEAT** indicator is lit on the display. Even when the power is turned off, this setting is maintained.

A to B repeat playback

If a specific portion between two points on the disc is specified, that portion can be played back repeatedly.

- 1 During playback and the repeat function is off, press and hold the **REPEAT** key on the remote control more than 1 second. Or set the repeat mode to A-B on the menu (menu number 03 REPEAT). **REPEAT** indicator flashes on the display.
- 2 Press the **REPEAT** key on the remote control or **PITCH** knob on the front panel at the beginning of the desired portion on the disc. **A-B** indicator flashes on the display.
- 3 At the end of the desired portion on the disc, press the **REPEAT** key on the remote control or **PITCH** knob on the front panel again. **REPEAT** and **A-B** indicators are lit up on the display, and the desired **A-B** section will be played repeatedly.

To cancel Repeat A-B mode and resume normal playback

Press the **REPEAT** key on the remote control once more. There are three additional ways to cancel repeat A-B mode:

- Press ■ key.
- Search the other track.
- Eject the CD.

NOTE

Both repeat start (A) and end (B) points can set to within a track.

NOTE

This function is not supported for MP3 playback.

7 - Advanced operations

Intro Check

The Intro Check function allows only the beginning of each track to be played for 10 seconds.

This function is operational both at stop and during normal playback.

- 1 Press the **STOP/INTRO CHECK** key on the front panel when **SHIFT** indicator is lit and playback stops. Or, pressing the **INTRO CHECK** key on the remote control to turn the intro check function on and off.

Int is shown on the display.

- 2 Press the **▶/||** key on the front panel or **▶** key on the remote control.

NOTE

This function works in normal (continuous) play mode and program play mode.

To exit the intro check mode, press **■** key on either the front panel or remote control, or **INTRO CHECK** key on the remote control.

NOTE

The intro check mode is also canceled when play mode is changed.

Output in monaural

Both analog and digital output can be set to mono output mode.

Set the mono output mode on and off on the menu (menu number 08 MONO).

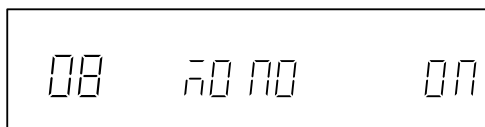

When the this function is on, **MONO** indicator is lit on the display.

Even when the power is turned off, this setting is maintained.

Power on play

By using an external timer, you can set the CD-01U/CD-01U Pro to play the loaded disc automatically when the unit is turned on by the timer.

- 1 First, plug the power cord of the CD-01U/CD-01U Pro into the power outlet of the timer.
- 2 Load a CD into the unit.
- 3 Set the **TIMER** menu (menu number 07 **TIMER**) to on.

- 4 Set the timer to the desired time.

Consult the timer's operation manual for details.

At the set time, the power to the CD-01U/CD-01U Pro will be turned on, and playback will automatically begin.

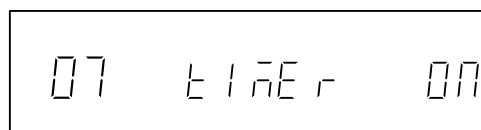

Pitch control

When playing back an audio CD or MP3, the pitch (or speed) of the playback can be varied.

Pitch can be varied +/- 12.5%.

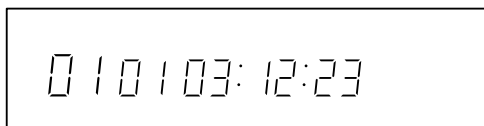

- 1 Press the **PITCH** knob on the front panel when **SHIFT** indicator is unlit or press the **PITCH** key on the remote control to turn the Pitch Control function on and off.

When the pitch control function is activated, pitch

value is shown on the display and **PITCH** indicator lights.

- 2 Rotate the **PITCH** knob or use the **PITCH +/-** keys to set the pitch.

Use the **PITCH** menu (menu number 12 **PITCH**) to adjust the pitch control steps from 0.1, 0.5, or 1.0% (Default: 0.1%).



Digital output provides the 44.1KHz digital signals constantly even if pitch control is activated.

7 - Advanced operations

Changing the playback speed without changing the key (Key Original)

When the Key Original function is ON, you can change the playback speed without changing the key.

Turn the Key Original function on and off on the menu (menu number 01 KEY-O). Or pressing the **KEY ORIG** key on the remote control turns this function on and off.

Use the **PITCH** knob on the front panel when **SHIFT** indicator is unlit, or use the **PITCH** and **PITCH +/-** keys to change the playback speed without affecting the key.

NOTE

When the Key Original function is ON, you may find that the audio has artifacts not present when just Pitch is used. This is an expected result of the Key Original processing, it does not indicate a problem with the unit.

Program playback

This function enables playback of selected tracks in any desired order. Up to 100 tracks can be selected from a CD for Program playback.

1 During stop mode, press the **PGM** key on the remote control.

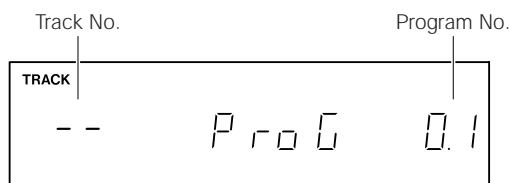

Or enter the program menu (menu number 4 ProG) then press the **PITCH** knob.

2 Use the number keys or **SKIP** keys on the remote control, or **SKIP** keys on the front panel to select each desired track for program playback.

3 Press the **SEARCH ►►** key. The track number will be entered into the program.

Or turning the **PITCH** knob right enters the selected track number into the program.

4 Repeat the above step 2 and 3 until the desired program is completed.

5 When program is completed, press the **PITCH** knob on the front panel or **PGM** key on the remote control.

Even when the power is turned off, program is maintained.

NOTE

When the disc is ejected, the program lists are erased.

Editing a programmed track

1 Enter the program mode.

2 Use the **SEARCH** keys to select the track for editing. Also using the **PITCH** knob on the front panel to select the track for editing.

The track number will be shown in the display.

3 Use the number keys or **SKIP** keys on the remote control or **SKIP** keys on the front panel to edit the programmed track.

4 When editing is completed, press the **PITCH** knob on the front panel or **PGM** key on the remote control.

Adding a track to the program

1 Enter the program mode.

2 Use the **SEARCH** keys on the front panel or remote control, or using the **PITCH** knob on the front panel to select the programmed track before the portion you wish to add a track.

The track number should be shown in the display.

3 Pressing the **DISPLAY** key and **SEARCH ►►** key simultaneously on the front panel or pressing the **A.RDY/INS** key adds the program step.

4 Use the number keys or **SKIP** keys on the remote control or **SKIP** keys on the front panel to input the track number of the track to be added.

5 Press the **PITCH** knob on the front panel or **PGM** key on the remote control to exit the program mode.

7 - Advanced operations

Deleting a programmed track

- 1 Enter the program mode.
- 2 Use the **SEARCH** keys to select the track for deletion. Also using the **PITCH** knob on the front panel to select the track for deletion. The track number will be shown in the display.
- 3 Pressing the **DISPLAY** key and **SEARCH** ◀◀ key simultaneously on the front panel or pressing the **A.CUE/DEL** key deletes the selected track.
- 4 Pressing the **PITCH** knob on the front panel or **PGM** key on the remote control exits the program mode.

Fade-in and fade-out

When this function is on and CD playback begins, the song fades in. When playback is finished, the song fades out.

The length of the fade in/out to/from the normal level can be set between 0.5 and 10 seconds in 0.5 second increments (Default setting: OFF).

- 1 To set the fade operation, enter the fade menu (menu number 05 FADE).



- 2 Press the **PITCH** knob on the front panel or **ENTER** key on the remote control to enter the fade in time setting.

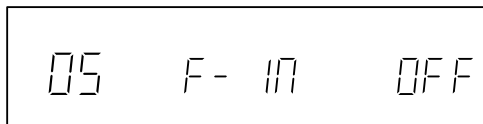

- 3 Set the Fade in time using with the **PITCH** knob on the front panel or **PREV/NEXT** keys on the remote control.
- 4 Press the **PITCH** knob on the front panel or **ENTER** key on the remote control to set the fade in time and enter the fade out time setting.

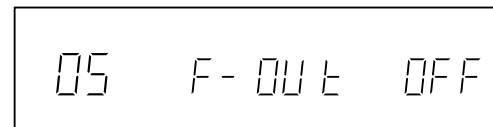

- 5 Set the Fade out time using with the **PITCH** knob on the front panel or **PREV/NEXT** keys on the remote control.
- 6 Press the **PITCH** knob on the front panel or **ENTER** key on the remote control to set the fade out time and exit the menu.

Relay Play

When the disc in the first unit in a chain plays to the end, the disc in the next unit in the chain will start.

WARNING

Make all connections with power off.

1. Check to see that all the CD-01Us are turned off.
2. Refer to the diagrams, and connect the first CD-01U's RELAY OUT to the second CD-01U's RELAY IN, the second CD-01U's RELAY OUT to the third CD-01U's RELAY IN, and so on. Finally, connect the last CD-01U's RELAY OUT to the first CD-01U's RELAY IN.
3. Switch on power to all the CD-01Us.

4. To activate the relay play function, set the relay play menu (menu number 06 RELAY) to on for all the units in the chain.

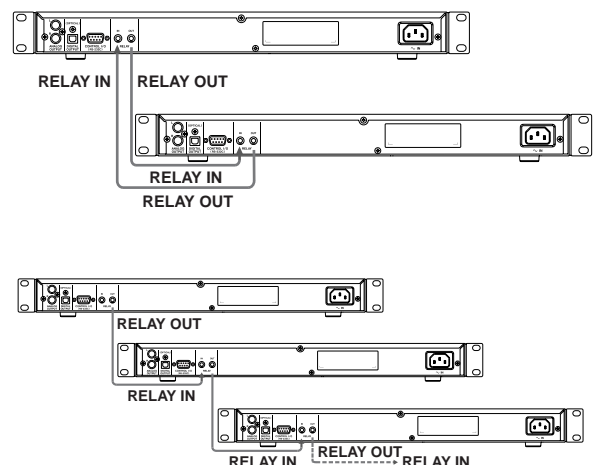

7 - Advanced operations

Time display switching

During audio CD playback (or playback standby), when the **DISPLAY** key on either the front panel or the remote control is pressed, the time display will switch through several modes in the following order.

- Elapsed track time (no display light indication)
- Remaining track time (**REMAIN** is lit in the display)
- Remaining disc time (**T.** and **REMAIN** are lit in the display)

When stopped, the total recording time is shown, regardless of the status of the **TOTAL** and **REMAIN** indicators.

When playing an MP3 disc, elapsed track time is always displayed, and the **DISPLAY** key does not operate. Even when the power is turned off, the time display mode setting is retained.

NOTE

When in program play mode, remaining total program time (when **T.REMAIN** is lit) and total program time (when stopped) are shown.

End of track warning (EOM)

When nearing the end of a track, a warning indication is shown on the display.

The number of seconds before the track end that the warning is displayed can be set beforehand, so that when playback reaches that point, the two colons will begin flashing on the display.

To set the warning display time, use the EOM menu (menu number 10 EOM).

EOM time can be set from OFF, 5, 10, 15, 20, 25, 30 (default), and 35.

This function is not supported for MP3 playback.

Eject block

When eject block is on, the **EJECT** key cannot be used when a disc is being played back or paused.

Use the eject block menu (menu number 02 BLOCK) to turn this function on and off.

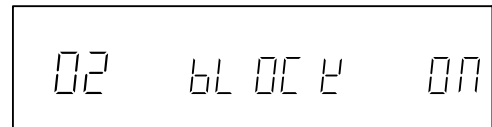

Fader start/Event start

Fader start/stop

Connect the **RELAY IN** jack (mini jack) on the rear panel and fader start terminal on the external device which supports the fader start function.

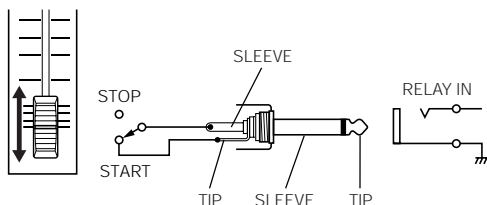

The relay play menu (menu number 06 RELAY) should be set to FDR.



For CD-01U Pro only, connect the **CONTROL I/O** (**PARALLEL**) terminal on the rear panel and fader start terminal on the external device.

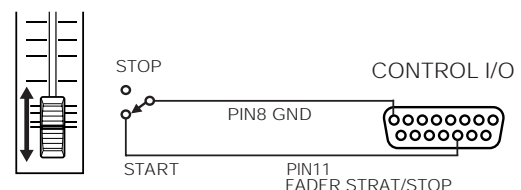

See more details for the **CONTROL I/O** terminal in the section External parallel control on page 24.

7 - Advanced operations

Event start

Connect the RELAY IN jack (mini jack) on the rear panel and event start terminal on the external device which supports the event start function.

The relay play menu (menu number 06 RELAY) should be set to ON.

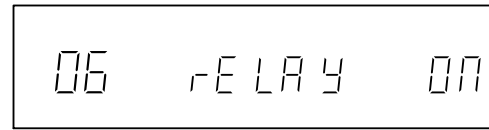

Restoring factory default settings

To restore all settings to their factory defaults:

- 1 Select the factory preset menu (menu number 14 F-PRE).
- 2 The display shows 14 flashing, then press the **PITCH** knob on the front panel or **ENTER** key on the remote control to confirm the selection.
- 3 The display shows - **SURE** - flashing to reconfirm that this operation is surely desired.

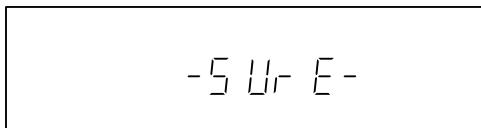

- 4 Press the **PITCH** knob on the front panel or **ENTER** key on the remote control to restore all settings to their default values.

The following settings are restored to default values.

- Playback mode
- Time display mode
- Auto ready
- Auto cue
- Pitch control value
- All menu settings

NOTE

You can cancel to restore the default settings either the stage 14 F-PRE or SURE is flashing by pressing the other keys except the SHIFT key and the PITCH knob on the front panel.

External parallel control

The CD-01U Pro can be controlled from an external devices which supports a parallel interface via the CONTROL I/O terminal on the rear panel.

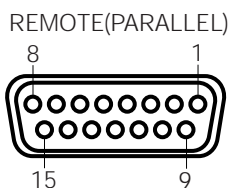

Pin No.	Description	In/Out
1	Stop tally	Out
2	Skip (Back)	In
3	Skip (Forward)	In
4	No Disc tally	Out
5	EOM tally	Out
6	Search (Back)	In
7	Search (Forward)	In
8	GND	
9	Play tally	Out
10	Pause tally	Out
11	Fader start/stop	In
12	Stop	In
13	Play	In
14	Pause	In
15	+5V	

In:

Input signals are active when low (ground) for > 30 ms.

Out:

Tally signals are open collector, with a maximum current of 50 mA.

+5V:

The maximum current supplied from this terminal is 50 mA.

8 - Specifications

Specifications

Type	Compact Disc player	
Discs	8 or 12cm (3.1 to 4.7inch) CD, CD-R/CD-RW	
Formats	Audio CD (CD-DA), MP3	
Number of channels	2-channel	
Resolution	16-bit	
Sampling frequency	44.1kHz	
Analog line outputs		
Connectors	RCA	
Maximum Output level	+6 dBV dBu	
Output impedance	1k Ω	
Analog line outputs (CD-01U PRO only)		
Connectors	XLR-3-32 (1:GND, 2:HOT, 3:COLD)	
Maximum Output level	+20 dBu	
Output impedance	150 Ω	
Headphones		
Connectors	standard stereo jack	
Maximum Output level	20 mW + 20 mW	
Load impedance	32 Ω	
Digital input (Coaxial)		
Connectors	Optical	
Format	IEC60958-3 (S/PDIF)	
Digital output (AES/EBU, CD-01U PRO only)		
Connector	XLR-3-32	
Format	IEC60958-4 (AES/EBU)	
Frequency response	20Hz to 20kHz +0.5/- 1.0dB	
S/N ratio	> 95dB (20kHz LPF A-WTD)	
Dynamic range	> 98dB (20kHz LPF A-WTD)	
Total harmonic distortion	< 0.01% (200Hz HPF, 20kHz LPF)	
Channel separation	> 90 dB (at 1 kHz)	
Wow and flutter	Below measurable limits (less than 0.001%)	
Voltage requirements		
	USA/CANADA	120 CVAC, 60 Hz
	U.K./Europe	230 VAC,50HZ
	Australia	240 VAC,50Hz
Power consumption		
	9 W (CD-01U)	
	11 W (CD-01U PRO)	
Dimensions		
	482.6 x 50 x 333.9 mm	
	19 x 2 x 13.1 (in)	
Weight		
	3.5 kg (7.7 lbs)(CD-01U)	
	3.7 kg (8.1 lbs)(CD-01U Pro)	
Operating temperature range	5 to 40 degrees C (41° F to 104° F)	

For product improvement, specifications and external appearance are subject to change without notice.

Due to product improvement, the actual unit may appear differently than illustrations in the operation manual.

8 - Specifications

Dimensional drawing

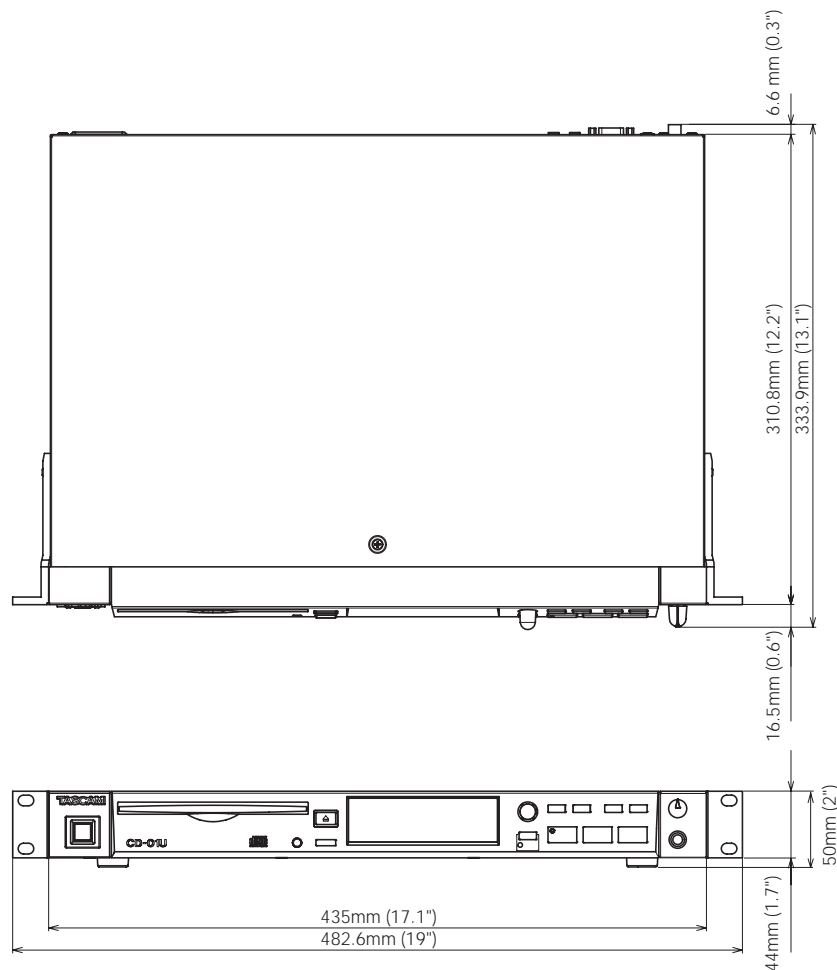

Error messages

- Err 01 TOC Read error - the disc's Table of Contents cannot be read - try with another disc or remove and clean the existing disc before replacing it
- Err 02 GFS error GFS signal cannot be detected - try with another disc or remove and clean the existing disc before replacing it
- Err 03 Focus error - after repeating the attempt eight times to focus, an error still occurs - try with another disc or remove and clean the existing disc before replacing it
- Err 04 Sub-Q error - the sub-Q code cannot be detected - try with another disc
- Err 05 Loading error - the loading operation cannot be completed, even after retries, or there is an internal error - make sure that there are no obstructions preventing the loading operation
- Err 06 Sled error - an internal drive error - try turning the power off, waiting a few seconds, and turning it on again
- Err 07 S-DRAM error - an internal S-DRAM error - try turning the power off, waiting a few seconds, and turning it on again
- Err 08 System error - an internal error - try turning the power off, waiting a few seconds, and turning it on again

If any of the numbered error messages occur, try using another disc.

If the errors continue with a number of discs, turn the unit off, wait for a few seconds, and turn it on again.

If the errors still continue or other error occurs, contact your TASCAM distributor for repair.

TASCAM

TEAC Professional Division

CD-01U / CD-01UPro

TEAC CORPORATION

Phone: +81-422-52-5082
3-7-3, Nakacho, Musashino-shi, Tokyo 180-8550, Japan

www.tascam.com

TEAC AMERICA, INC.

Phone: +1-323-726-0303
7733 Telegraph Road, Montebello, California 90640

www.tascam.com

TEAC CANADA LTD.

Phone: +1905-890-8008 Facsimile: +1905-890-9888
5939 Wallace Street, Mississauga, Ontario L4Z 1Z8, Canada

www.tascam.com

TEAC MEXICO, S.A. De C.V.

Phone: +52-555-581-5500
Campeños No. 184, Colonia Granjes Esmeralda, Delegación Iztapalapa CP 09810, Mexico DF

www.tascam.com

TEAC UK LIMITED

Phone: +44-1923-438880
5 Marlin House, Croxley Business Park, Watford, Hertfordshire. WD1 8TE, U.K.

www.tascam.co.uk

TEAC EUROPE GmbH

Phone: +49-611-71580
Bahnstrasse 12, 65205 Wiesbaden-Erbenheim, Germany

www.tascam.de

TEAC ITALIANA S.p.A.

Phone: +39-02-66010500
Via C. Cantu 11, 20092 Cinisello Balsamo, Milano, Italy

www.teac.it