

Schematic Diagrams
Diagrammes schématiques
Schematische Diagrammen
Schematische Diagramme
Diagramas Esquemáticos

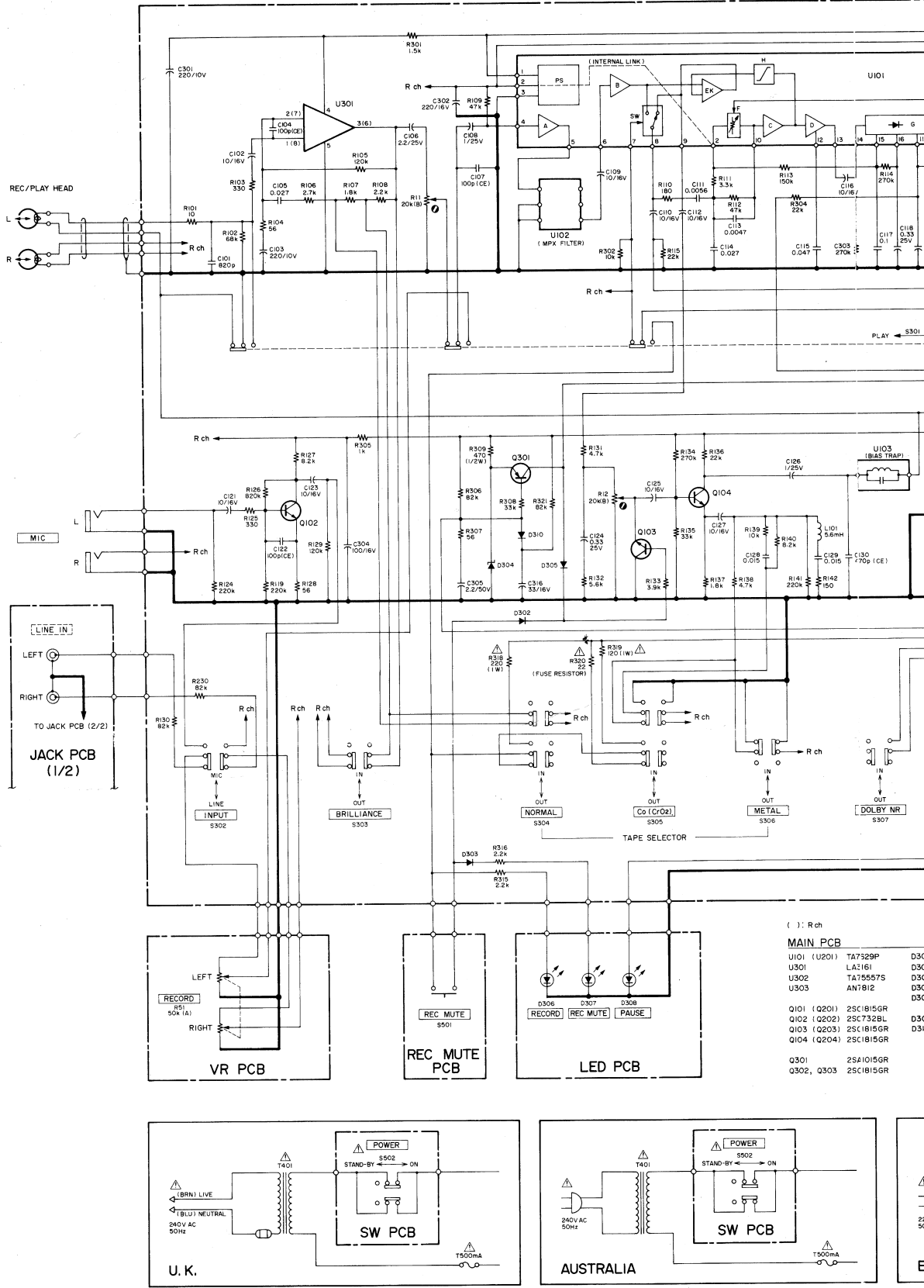

() : R ch

MAIN PCB

U101 (U201)	TA7529P	D301
U301	LA2161	D302
U302	TA75557S	D303
U303	AN7812	D304
		D305

Q101 (Q201)	2SC1815GR	D306
Q102 (Q202)	2SC752BL	D307
Q103 (Q203)	2SC1815GR	D308
Q104 (Q204)	2SC1815GR	D309

Q301	2SA1015GR
Q302, Q303	2SC1815GR

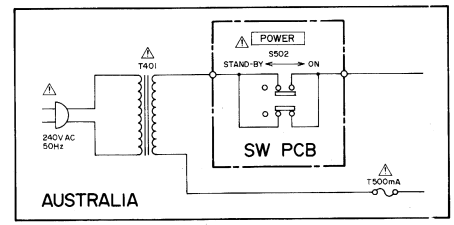
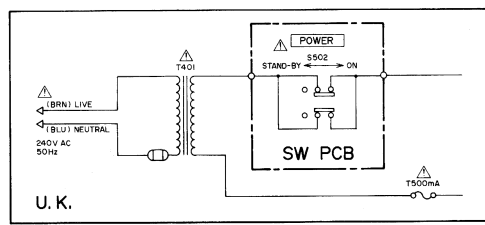
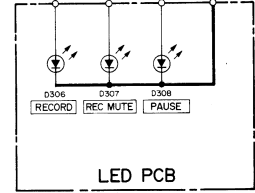
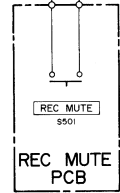
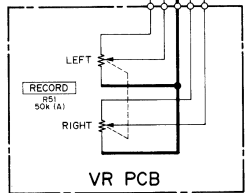

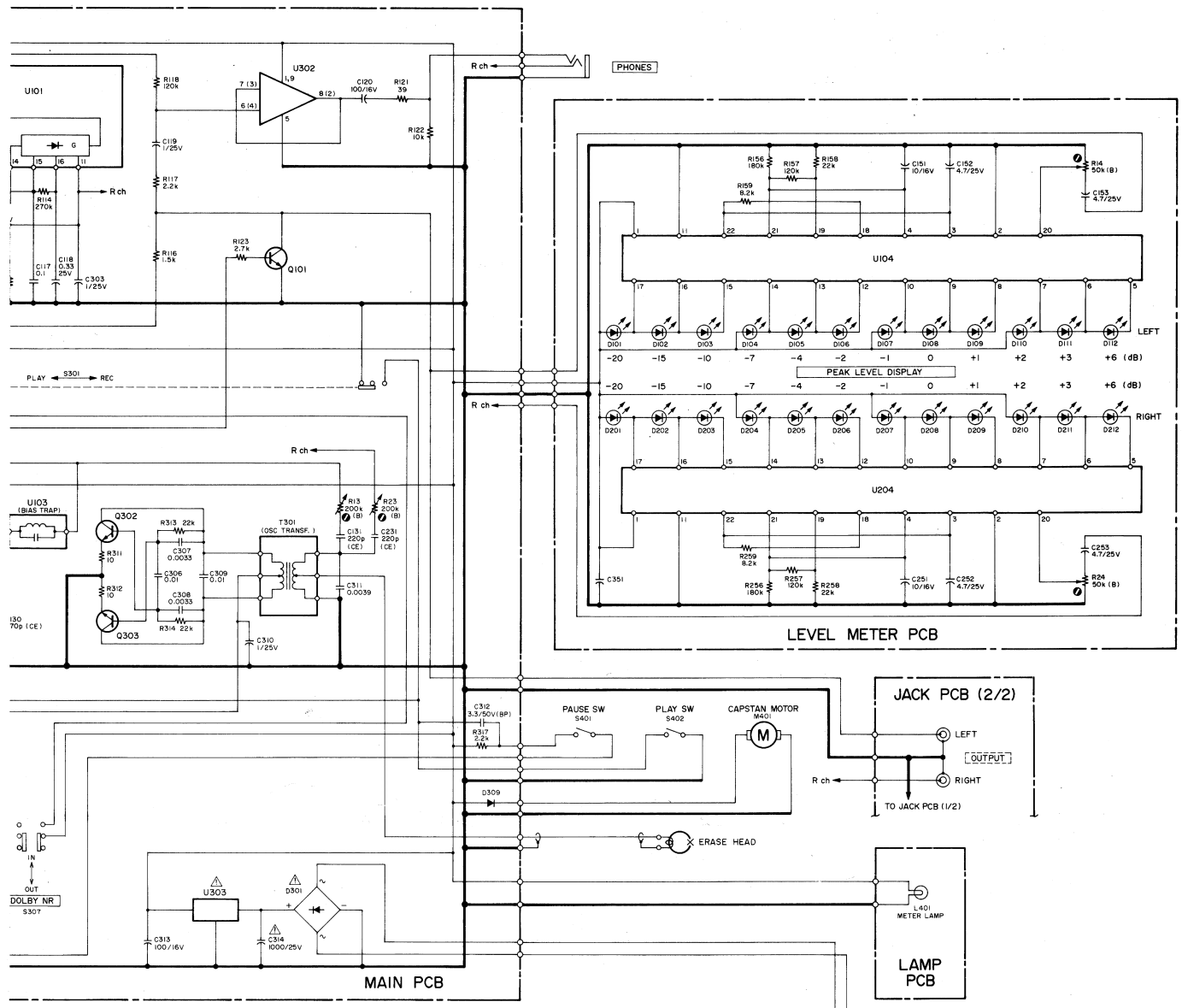

LEVEL METER PCB		
329P	D301	IB4B42
I61	D302	IS1555
5557S	D303	IS1555
B12	D304	OS210Y
	D305	IS1555
IB15GR	D309	SS277B
7329L	D310	IS1555
IB15GR		
IB15GR		
IO15GR		
IB15GR		

LED PCB		
D306 ~ D308	TLR205	

