

# Service Manual

Minidisc Deck  
**SJ-MD100**

**Supplement**

## Colour

(K) ..... Black Type

## Areas

(E) ..... Europe.  
(EB) ..... Great Britain.  
(EG) ..... Germany.

## ■ This document is supplementary to the following Service Manual:

Model No.	Area Code	Order No.
SJ-MD100	(E) (EB) (EG)	MB9902001C2

## ■ Purpose

Supplement for technical information about MD.

## ■ Contents

### 1. Measuring instruments and special tools

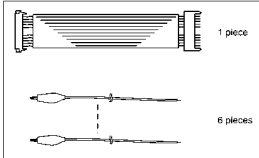
Test Disc	<ul style="list-style-type: none"> <li>● ROM Part No.: RFKV0006</li> <li>● ROM Part No.: RFKV0014</li> </ul>
Extension Cable Kit	<ul style="list-style-type: none"> <li>● Extension Cable Kit Part No.: RFKZJMD100EK</li> </ul> 
Laser Power Meter	<ul style="list-style-type: none"> <li>● Laser Power Meter Model No.: LE8010 Made by Laser Electric</li> </ul>

### 2. Basic Knowledge of MD

### 3. Operating Procedures

### 4. Troubleshooting Guide for MD Servo Circuit

## ⚠ WARNING

This service information is designed for experienced repair technicians only and is not designed for use by the general public. It does not contain warnings or cautions to advise non-technical individuals of potential dangers in attempting to service a product. Products powered by electricity should be serviced or repaired only by experienced professional technicians. Any attempt to service or repair the product or products dealt with in this service information by anyone else could result in serious injury or death.

# Technics®

© 1999 Matsushita Electric Industrial Co., Ltd.  
All rights reserved. Unauthorized copying  
and distribution is a violation of law.

## Basic Knowledge of MD

### Definition of an MD and the types of MDs

<ul style="list-style-type: none"> <li>● What is an MD?</li> <li>● Two types of MDs</li> <li>● Playback-only MD is same as a CD.</li> <li>● Recordable MD uses magnet optic recording.</li> <li>● Playback of a Recordable MD</li> <li>● 74-minute recording time</li> <li>● Can also be used on a computer.</li> </ul>	<ul style="list-style-type: none"> <li>● "MD" stands for "mini disc".</li> <li>● Similar to a music CD, an MD is also a small disc capable of recording and playing back digital sound.</li> <li>● There are 2 types of MDs, a optical disc for playback-only MD and a magnet optic disc for recordable MD that is capable of both recording and playback.</li> <li>● A playback-only MD is merely a smaller-diameter version of a CD. Just like a CD, the signals are read by light striking pits on the surface of the disc.</li> <li>● With a magnet optic disc MD(Recordable MD) that is capable of both recording and playback, recording is performed by a vertical magnetization system in which a magnetic thin film on the surface of the disc is heated by a laser beam, and magnetism is applied in accordance with the data (audio signal) being recorded.</li> <li>● When a recordable MD is played back, a laser beam weaker than that used during recording strikes the disc and is reflected back, and the reflected light is twisted (polarized) in accordance with whether the magnetized direction is upward or downward, causing the reflected light to rotate very slightly clockwise or counterclockwise. Those subtle differences in the reflected light are picked up by two light-receiving elements and detected as either a "1" or a "0" by reading whether there is electrical current or no electrical current.</li> <li>● If an MD were recorded in the same way as a CD, it would only have about 15 minutes of recording time. However, by using a new signal compression technology called ATRAC that was specifically developed for MDs, the signals are compressed to approximately one-fifth, making it possible to record for an extended time of 74 minutes, the same as with a CD. (Blank MDs are currently marketed in two recording times, 74 minutes and 60 minutes.)</li> <li>● Although MDs were originally developed for use in recording and playing back music, in July 1993 the "MD data" standard was established. By using an MD data+music player, MDs can be used as external memory storage media for computers, and a single MD has a storage capacity of 140 MB, equivalent to about 100 floppy discs.</li> </ul>
---	--

### Construction of an MD

<ul style="list-style-type: none"> <li>● Construction of an MD</li> <li>● Materials used in an MD</li> </ul>	<ul style="list-style-type: none"> <li>● The playback-only MD and the recordable MD are exactly identical in size and shape.</li> <li>● The figure below is a cross-sectional diagram of an MD disc. The diameter of an MD disc is 6.4 cm, approximately half that of a CD, and the thickness is 1.2 mm, the same as a CD. Similar to a CD, only one side of an MD disc is used to store data.</li> <li>● The MD disc is made of polycarbonate, the same material that is used for a CD. Polycarbonate is a type of engineering plastic that is highly resistant to temperature and humidity, as well as having excellent wear and impact resistant.</li> <li>● A clamping plate is mounted in the center of the MD disc, and when the MD is loaded into a player, a magnet in the player attracts that metal plate to secure the disc in place. If the MD disc were to be secured by clamping it from above and below similar to a CD, it would be necessary to have a hole pass through the center of the MD cartridge, which would reduce the amount of space available for attaching a label. By using this magnetic method of securing the disc, the entire front side of the MD cartridge can be used as a label area.</li> <li>● Because of the metal plate mounted at the center of the MD disc, the center of the cartridge is 2 mm thick, slightly thicker than the rest of the cartridge.</li> <li>● To protect the MD disc from dust, fingerprints, and other things that might hinder the reading of the recorded signals, the disc is stored inside a cartridge similar to that of a floppy disc. When the MD is loaded into a player, the shutter on the cartridge is opened and the disc is ready to be played.</li> <li>● For a recordable MD, because there is no need for a recording head and it is only necessary for a laser beam to be directed at the underside of the disc, the shutter is located only on the back of the cartridge.</li> <li>● For a playback/record magnet optic disc MD, because it is necessary for the recording head and the laser beam to be able to access both sides of the disc, the shutter is located on both sides (upper shell and lower shell) of the cartridge.</li> </ul>
--	--

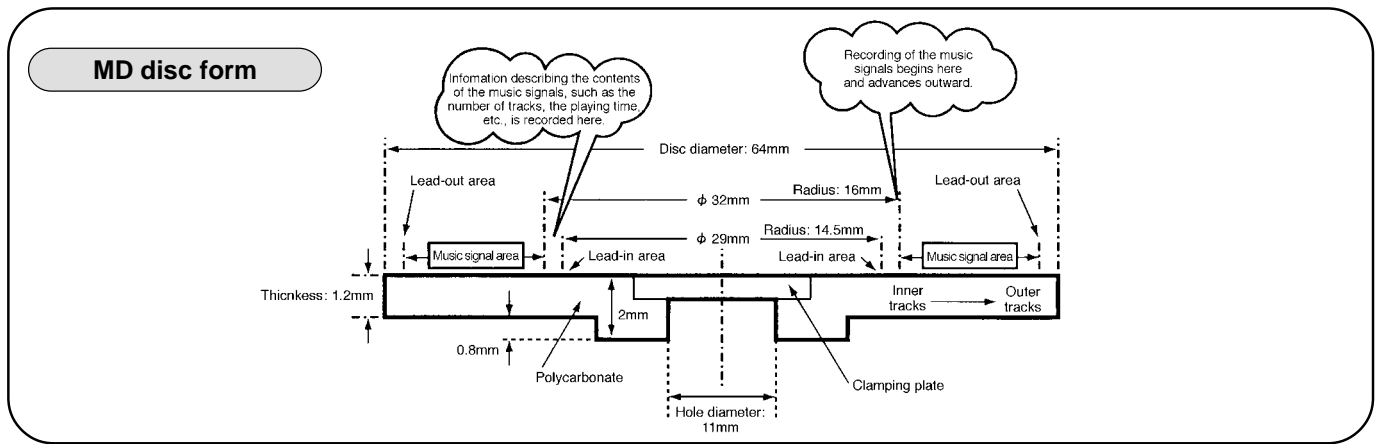
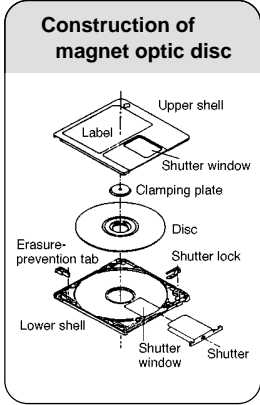

● Recording on a magnet optic disc

<ul style="list-style-type: none"> <li>● Can be recorded and played back repeatedly.</li> <li>● Recording principle</li> <li>● Vertical magnetization system</li> <li>● Number of recordings possible</li> </ul>	<ul style="list-style-type: none"> <li>● By using a magnet optic disc, digital signals can be recorded and played back over and over again.</li> <li>● To record on a magnet optic disc, a laser beams momentarily heats "pin spots" on the magnetic film on the back of the disc and a magnetic field is applied from the other side of the disc. Thus, both sides of the disc must be accessed in order to record.</li> <li>● To explain the recording principle, we will assume that the directions of the magnetism on an unrecorded disc are all facing downward (south-north = "0 0 0 0 ..."). (Actually on an unrecorded disc the directions are random.)</li> <li>● Thus, to record the signals "1 0 1 1 0 1 0", the direction of the magnetism at the locations where "1" is to be recorded must be changed to face upward (north-south). Because the magnetic film is strongly magnetic, once a downward-facing magnetism is recorded, it is not easy to change it to an upward-facing magnetism.</li> <li>● By directing a laser beam at the magnetic film, the temperature of the location that the laser beam strikes rises to the Curie temperature (recordable MD; about 180°C), eliminating the magnetic force (retention force). (Because the magnetic film is strongly magnetic, similar to a permanent magnet, once it is magnetized it has a strong retention force. In order to eliminate that retention force, it is irradiated with a laser beam so that the temperature rises to the Curie temperature.)</li> <li>● After the magnetism of the specific location is eliminated, an external magnetic field with an upward direction (north-south) is applied, thus changing the direction of the magnetism at that location to face upward (north-south).</li> <li>● Conversely, if a downward-facing (south-north) external magnetic field is applied, the direction of the magnetism at that location is changed to face downward (south-north).</li> <li>● Then, when the disc rotates and the location which has been changed to upward-facing magnetism leaves the laser spot, the temperature of the magnetic film drops, and the upward-facing magnetism recorded at that location is retained.</li> <li>● In this way, digital signals of "1" (upward-facing magnetism) and "0" (downward-facing magnetism) are recorded on the tracks on the disc.</li> <li>● With a conventional magnetic recording tape, the magnetic material is magnetized parallel (horizontal) to the surface of the tape. A magnet optic disc, however, uses a vertical magnetization system in which the magnetic poles are recorded perpendicular (vertical) to the disc surface. Because the magnetism is recorded vertically rather than horizontally, much more data can be recorded in a smaller area.</li> <li>● A magnet optic disc can be recorded more than 1 million times, so it can virtually last forever.</li> </ul>
--	---

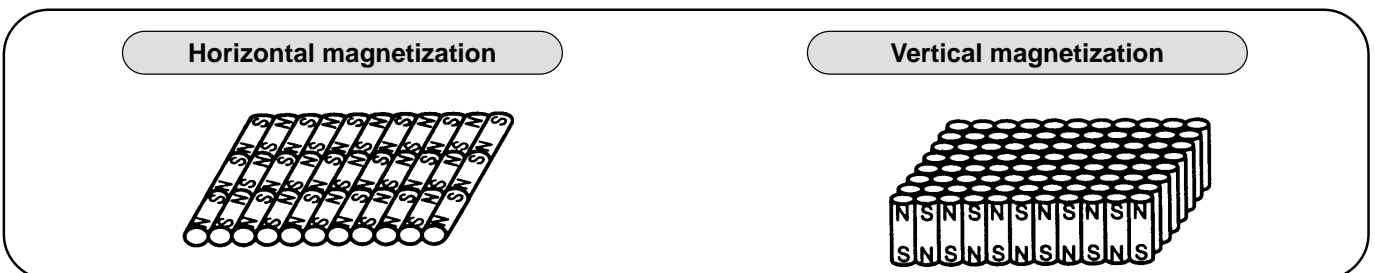
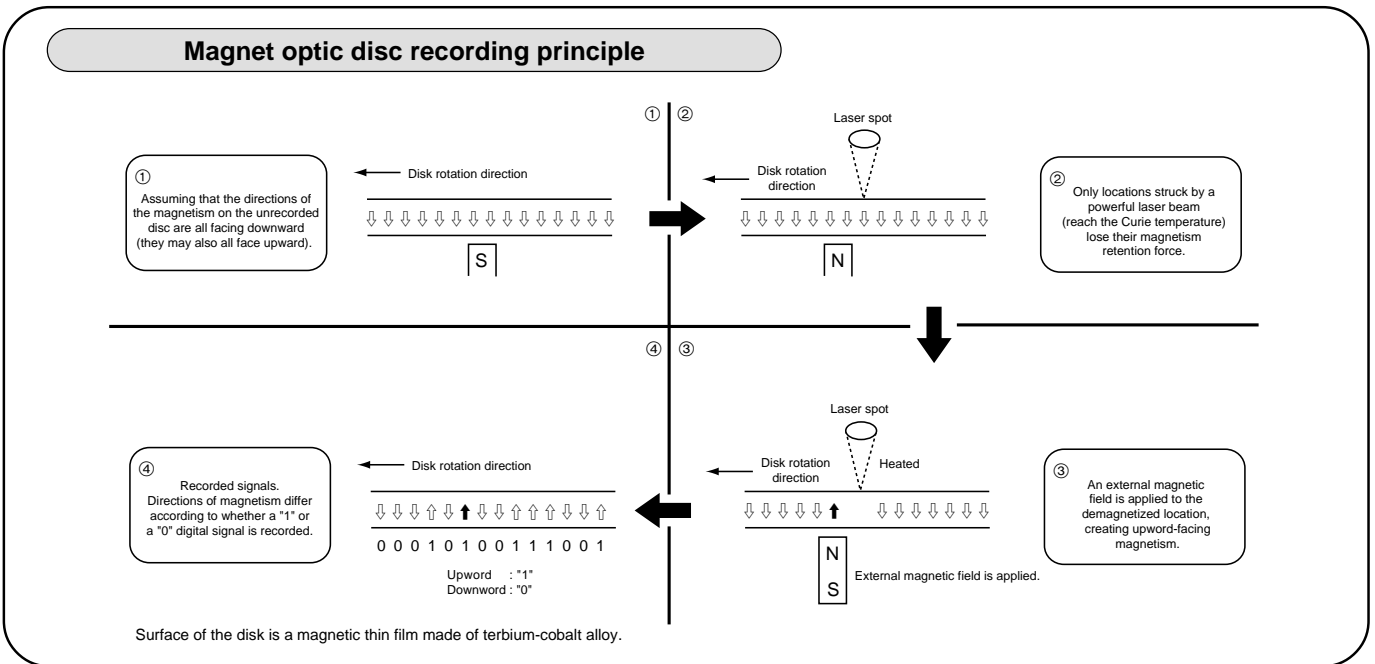

● Playback of a recordable MD

<p>● Playback of a recordable MD</p>	<ul style="list-style-type: none"> <li>• Because the signals on a magnet optic disc are recorded vertically as north-south and south-north magnetism, the north and south magnetic poles appear on the surface of the disc's magnetic film. These signals are played back utilizing a phenomenon called the "Kerr effect" which occurs when a weak laser beam strikes the magnetic poles.</li> <li>• Light has wave vibration directions called "planes of polarization". ("Polarization" refers to a light wave which vibrates only in a fixed direction.)</li> <li>• With normal light, because the wave vibration directions are all mixed, no planes of polarization appear.</li> <li>• Because a laser beam is artificially generated light, it is possible to align the planes of polarization.</li> <li>• When a laser beam strikes something that has a magnetic field, the direction of the plane of polarization of the reflected light varies very slightly in accordance with whether the magnetism is north polarity or south polarity. When playing back a magnet optic disc MD, these slight changes in the direction of the plane of polarization are read.</li> </ul>
<p>● Reading of magnetic signals</p>	<ul style="list-style-type: none"> <li>• To further explain the principle used to read the signals recorded on a magnet optic disc, first a laser beam is directed at the disc. If the direction of the magnetism recorded on the disc is upward (north polarity), the plane of polarization of the light reflected from the disc rotates very slightly clockwise as a result of the Kerr effect. Conversely, if the direction of the magnetism is downward (south polarity), the plane of polarization rotates very slightly counterclockwise.</li> <li>• When the reflected laser light is passed through a Wollaston prism, the light is distributed to photo detector 1 if the direction of rotation is clockwise or to photo detector 2 if the direction of rotation is counterclockwise.</li> <li>• The light striking the two light receiving elements is converted into electrical current and a subtraction is performed. If the result of A-B is plus, a "1" is detected, and if the result of A-B is minus, a "0" is detected.</li> <li>• An MD player is compatible with both optical recording and magnetic recording, changing the reading system in accordance with the type of disc that is loaded.</li> </ul>

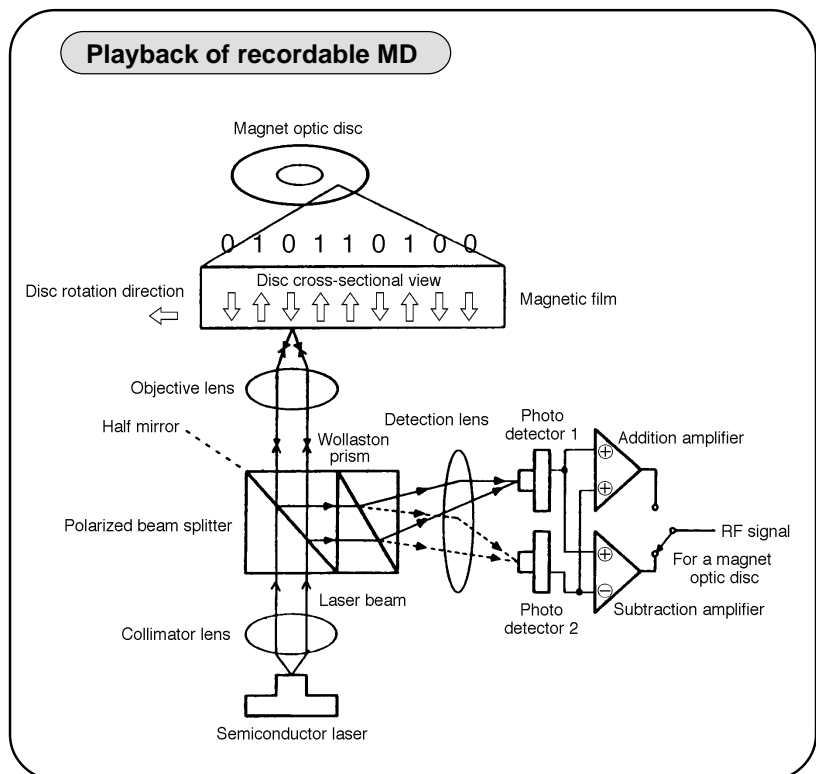
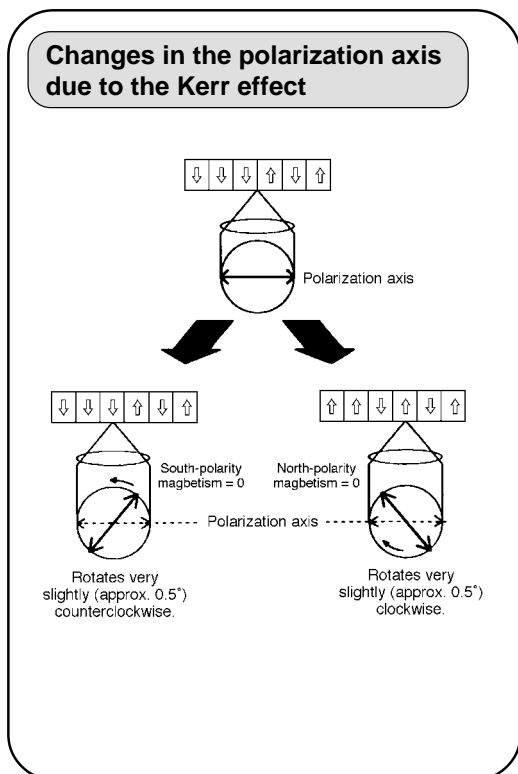

● **Rewriting action of a magnet optic disc**

<p>● MD rewriting process</p>	<ul style="list-style-type: none"> <li>• The signals recorded on an MD are rewritten using a new process called “magnetic field modulation overwriting”<sup>*</sup>.</li> <li>• In this process, a laser beam spot of about 5 mW is focused on the location on the disc to be rewritten, heating that location to the Curie temperature (180°C) and thus canceling the magnetization.</li> <li>• At the same time, current flows to the optical pickup and to the magnetic head opposite it, between the two of which the disc is held, thus generating a magnetic field.</li> <li>• When the disc revolves so the laser spot moves from the location to be rewritten, the temperature drops below the Curie temperature and the magnetic field generated by the magnetic head re-magnetizes that location.</li> <li>• At this time, if the direction of the current flowing to the magnetic head is reversed in accordance with whether the data being recorded is “1” or “0”, the direction of the magnetic field also changes between north and south, and accordingly, the direction of the magnetization of the recording film changes between upward-facing and downward-facing. Thus, it is possible to directly magnetize the recording film on the disc in accordance with the “0” and “1” digital signals.</li> </ul>
<p>● No need for an erasing head</p>	<ul style="list-style-type: none"> <li>• Thus, the new recording data is overwritten regardless of the direction of the previously recorded magnetization, eliminating the need for an erasing head.</li> <li>• This process is called “magnetic field modulation overwriting”.</li> <li>• Because this “magnetic field modulation overwriting” makes it possible to directly overwrite the new signals on top of the old signals in a single process, re-recording on a MD is just as easy as with a magnetic tape, making the MD ideally suited for use in personal audio equipment.</li> </ul>

**Magnetic field modulation overwriting**

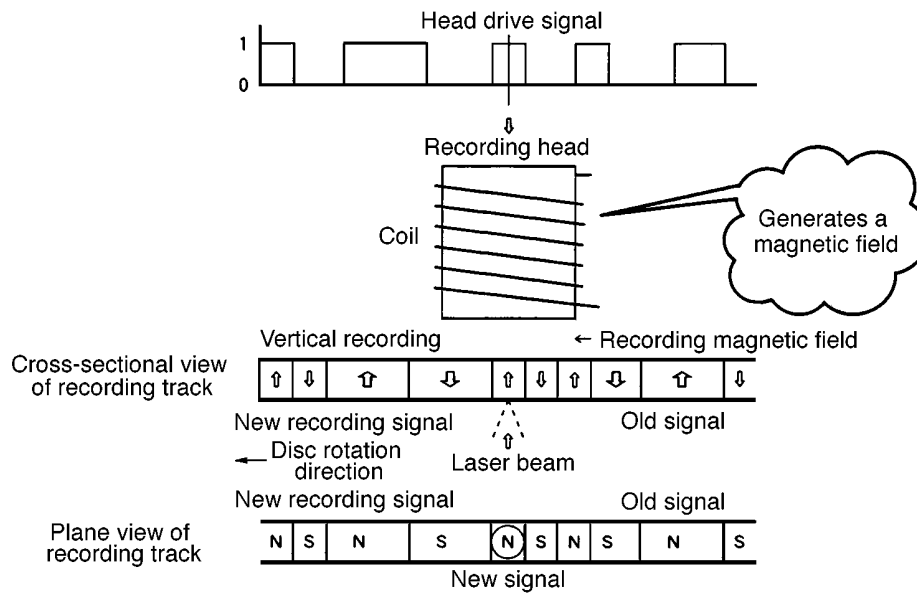

\*Overwrite means to write new data while erasing the old data.

● Random access on a recordable MD

<p>● Random access on a playback-only MD</p>	<ul style="list-style-type: none"> <li>• With a disc, high-speed random access is possible, something which is not possible with a tape.</li> <li>• The optical pickup moves quickly in the radial direction, thus directly accessing the start of each track.</li> <li>• With an optical disc, which is capable of playback only, the addresses in the TOC (table of contents) in the lead-in area are all read beforehand in order to access the start of each track.</li> </ul>
<p>● Random access on a recordable MD</p>	<ul style="list-style-type: none"> <li>• With a recordable MD, which is capable of both recording and playback, blank guide grooves, called "pre-grooves", are formed around the entire surface of the disc at the production stage.</li> <li>• As shown in the illustration below, the pre-grooves wobble very slightly in a regular pattern, and that curve is fine-modulated (at intervals of 13.3 ms) to record beforehand the addresses of the continuous time data.</li> <li>• Technically speaking, the pre-grooves in the disc is not perfect spiral but is wobble with :             <ul style="list-style-type: none"> <li>– a typical amplitude of 30 nm.</li> <li>– a spatial period of 54 to 64 <math>\mu\text{m}</math>.</li> </ul> </li> </ul> <p>When this wobble is locked to a frequency of 22.05 kHz, the velocity of the disc should be in the range of 1.2 to 1.4 m/s.</p> <ul style="list-style-type: none"> <li>• In this way, even if the MD is blank, because the addresses are already recorded around the entire circumference of the disc, when the MD is recorded, those addresses are read in order to control the movement of the optical pickup and perform CLV control.</li> <li>• To record immediately, quick access is first performed to quickly search for a blank area on the disc, and then recording will automatically begin. When recording is completed, that address is automatically recorded in the U-TOC (user table of contents) area, so it can be read during playback for quick and easy access. This also makes it easy to edit the track number.</li> </ul>
<p>● User TOC area</p>	<ul style="list-style-type: none"> <li>• Thus, with an MD, when the recording is completed, the track data is automatically written in the U-TOC area at the innermost part of the magnetooptic disc. The data is then read during playback for quick and easy access.</li> <li>• The addresses for the start locations of each track (track mark), and also the addresses for the end locations, are all recorded in the U-TOC, so when editing a track all that has to be rewritten is the area address.</li> <li>• This is similar to the directory that a computer writes on a floppy disk.</li> </ul>

Pre-grooves on a magnet optic disc

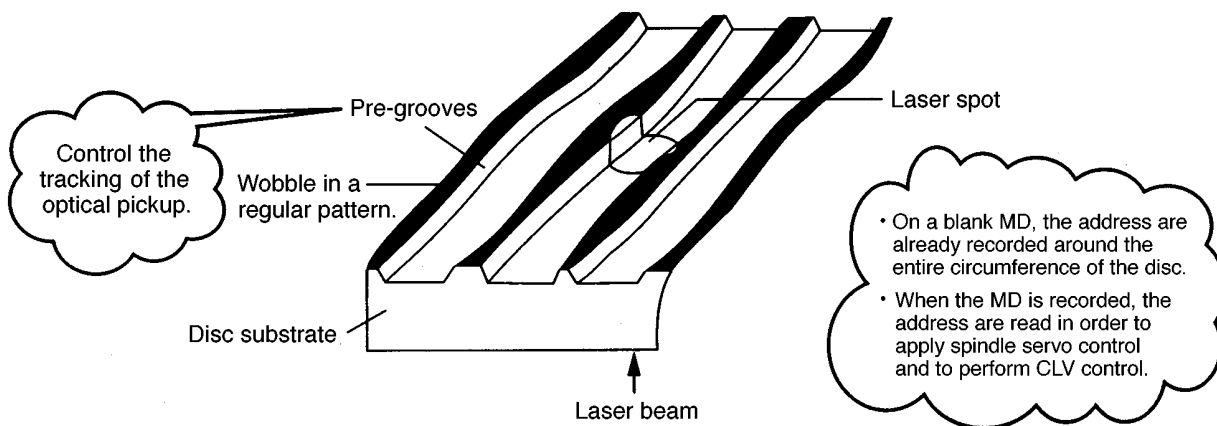

\*Spindle servo control means control of the disc's rotation speed.

● **ATRAC signal compression technology**

<p>● What does the word ATRAC mean?</p>	<ul style="list-style-type: none"> <li>• “ATRAC” (adaptive transform acoustic coding) is the name given to the signal compression technology that is one of the most important technologies used in the MD system. The principles of this technology are extremely complex, so here we will only explain the basic concept.</li> <li>• Simply speaking, utilizing the characteristics of the human auditory sense, the sounds that cannot be heard by the human ear are eliminated so that only the sounds that can be heard remain, thus reducing the amount of data that must be recorded. This principle is similar to the PASC signal compression that is used for digital compact discs.</li> </ul>
<p>● Why is signal compression necessary?</p>	<ul style="list-style-type: none"> <li>• The amount of data that can be recorded per second (the bit rate) is 16 bits x 44,100 x 2 channels = 1,411,200 bits per second, or approximately 1.4 megabits per second (1 megabit = 1,000 kilobits = 1 million bits).</li> <li>• However, because the diameter of an MD is only about one-half that of a CD, it only has a capacity of about 160 megabytes. In order to record the same 74 minutes of data as a CD, the bit rate of 1.4 megabits per second must be compressed to one-fifth. “ATRAC” is the signal compression technology that was developed in order to do that. (Signal compression is rather like the technology for orange juice concentrate, in which the best part of the fresh orange is concentrated for easy transportation and then reconstituted with water before drinking.)</li> </ul>
<p>● Basic concept of ATRAC</p>	<ul style="list-style-type: none"> <li>• The basic concept of ATRAC utilizes the characteristics of the human auditory sense. The frequency spectrum that cannot be heard by the human ear (Fig. B) and the frequency spectrum that cannot be heard because it is masked by high-level sounds (Fig. C) are cut, and the bit rate is compressed by appropriately arranging the bits, thus making it possible to fit all of the necessary data within the capacity of the disc.</li> <li>• Technically speaking, the analog signals are converted to 44.1-kHz 16-bit digital signals, and these signals are then processed by the ATRAC encoder. Using a maximum time of 11.6 ms as a single unit, the encoder converts the digital waveforms within each single unit into about 500 different frequency spectra and then analyzes the strength level of each frequency. Then, as shown in the figures below, utilizing the two principles of the “threshold of audibility” and the “masking effect”, only the signals actually heard by the human ear are selected and compressed to one-fifth the original volume.</li> <li>• This complex process is performed by an LSI chip called the ATRAC.</li> </ul>

**Threshold of audibility**

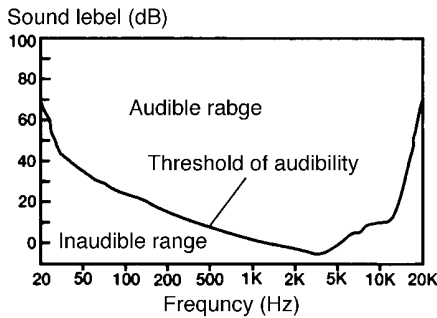

Fig.A

**Signals below the threshold of audibility are eliminated**

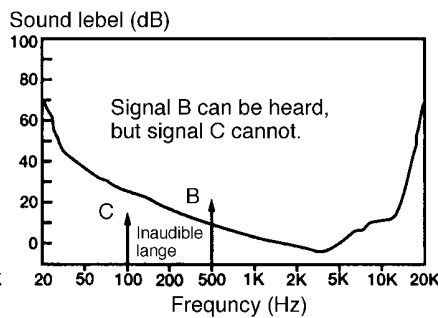

Fig.B

**Masking by high-level sounds**

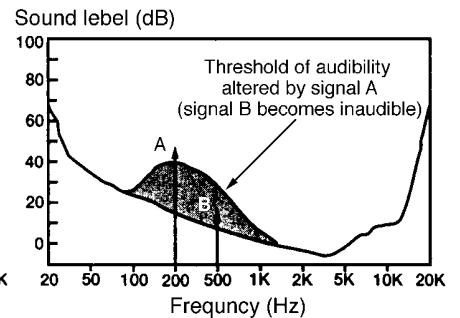
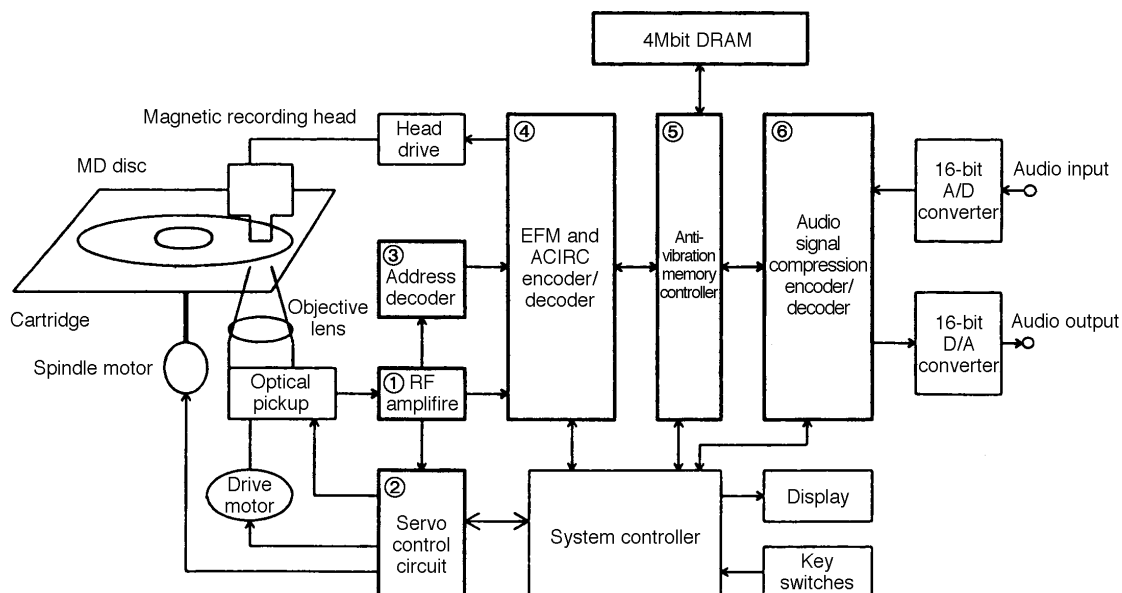

Fig.C

● Composition of an MD system

<p>● Development of 6 LSIs</p>	<p>• The figure below shows the composition of an MD system. An MD system uses six LSIs that were specifically developed for MD. The following is a description of the functions of those six LSIs.</p>
<p>① RF amplifier</p>	<p>• This LSI controls the laser and performs the detection processing of the servo signals and of the audio signals from the disc needed to correct the position of the laser spot.</p>
<p>② Servo control circuit</p>	<p>• This LSI receives the laser spot position correction signals from the RF amplifier and controls the focus servo that ensures that the laser spot is correctly focused on the disc surface and the tracking servo that controls the disc rotation direction to ensure that the pits on the disc surface are traced correctly.</p>
<p>③ Address decoder</p>	<p>• This LSI demodulates the address signals that are recorded in the pre-group on a playback/record magneto-optical disc MD. In addition to reading the absolute addresses, the address decoder also functions to control the rotation speed so that the servo signal is obtained at a constant linear speed at the location being read.</p>
<p>④ EFM and ACIRC encoder/decoder</p>	<p>• This is the main signal processing LSI. EFM is a circuit which converts 8-bit digital signals into the 14-bit format recorded on the disc. It also performs signal processing for error correction, changing the interleaving format in order to use the ideal algorithm for MD. In addition, this LSI also performs other tasks such as encoding during recording and decoding during playback.</p>
<p>⑤ Anti-vibration memory controller</p>	<p>• This memory controller provides a "shock-proof" memory.</p>
<p>⑥ Audio signal compression encoder/decoder</p>	<p>• This LSI performs the signal processing for the ATRAC compression technology that was specifically developed for MD.</p>
<p>● New generation LSIs</p>	<p>• New generation LSIs developed for higher performance of MD system. There are reduced to three LSIs.</p>
<p>1. RF amplifire</p>	
<p>2. 4 ch driver (servo control)</p>	
<p>3. Signal processor</p>	

Block Diagram for playback/record MD circuit





## ■ Operating Procedures

### Play

- P1. To read the signals recorded on the disc, the laser beam emitted by the laser diode (LD) strikes the disc and is reflected back and detected by the photodetector (PD).
- For a pre-mastered disc, similar to a CD, the signals are recorded as pits on the surface of the disc, and the signals are detected by the amount of light reflected when the laser beams strikes the pits.
  - For a recordable disc, the signals are recorded by magnetizing the magnetic film on the surface of the disc and there is no variation in the amount of light that is reflected, so the signals are detected using the shifting of the polarization of the reflected light due to the Kerr effect\*1.
- P2. The detected signals are input to pins 38 and 39 of the RF IC (IC1), where they are amplified and then output from pin 32.
- By observing the input signals (between pins 38 and 39) and the output signals (pin 32) on an oscilloscope, it is possible to check the eye pattern.
- P3. Error correction of the amplified signals is performed by the MD LSI (IC3: MN66616) using EFM demodulation and ACIRC\*2 and the signals are stored in the DRAM (IC72: MNV4400). At this time, the cycle of the signals is adjusted by the LSI's clock in order to eliminate any jitter that might result from irregular revolution of the disc.
- P4. The signals are sequentially taken from the DRAM (IC72) and sent back to the MD LSI (IC3), where they are ATRAC\*3-decoded and then output from pin 64.

All of the above steps 1 through 4 are processed on the MD servo PCB, and all of the signals are digital.

- P5. The digital signals output from the MD LSI are input to pin 13 of the A/D-D/A converter (IC601: AK4520) via the interface IC (IC401: TC74HCT7007; input: pin 3; output: pin 4), where they are converted to analog signals and then output from pins 26 (left channel) and 27 (right channel).
- P6. The analog-converted signals are output to LINE OUT via the buffer amp (IC711: BA4560; input: pins 5 (left channel) and 3 (right channel); output: pins 7 (left channel) and 1 (right channel)). At the same time, they are also output to the headphone amp (IC801: M5218; input: pins 5 (left channel) and 3 (right channel); output: pins 7 (left channel) and 1 (right channel)).
- The MD servo PCB operates at  $V_{cc} = 3.3$  V, and the main PCB operates at  $V_{cc} = 5$  V. For that reason, the exchange of signals between the two PCBs is performed via an interface IC (during playback: IC401 (TC74HCT7007); during recording: IC402 (TC74HCT4050)).
  - The exchange of signals between the DRAM and the MD LSI is performed using four data lines (pins 1, 2, 24, and 25 of the DRAM and pins 43, 44, 45, and 46 of the MD LSI).

### Record

- R1. The analog signals input from LINE IN pass through the REC LEVEL VR and are input to pins 5 (left channel) and 3 (right channel) of the A/D-D/A converter (IC601) via the buffer amp (IC751: BA4560; input: pins 5 (left channel) and 3 (right channel); output: pins 7 (left channel) and 1 (right channel)).
- R2. The analog signals input to the A/D-D/A converter (IC601) are converted to digital signals with a sampling frequency of  $f_s = 44.1$  kHz and then output from pin 14 to pin 65 of the MD LSI (IC3) via the interface IC (IC402: TC74HCT4050 ; input: pin 3; output: pin 4).
- R3. The signals input from OPTICAL IN are input to pins 70 and 71 of the MD LSI (IC3) via the interface IC (IC401; input: pin 9; output: pin 8).
- R4. The signals input to pins 70 and 71 of the MD LSI (IC3) are converted to a sampling frequency of  $f_s = 44.1$  kHz by an  $f_s$  converter inside the LSI. If the signals are already  $f_s = 44.1$  kHz, they bypass the  $f_s$  converter.
- R5. The signals converted to  $f_s = 44.1$  kHz or the signals input to pin 65 are ATRAC-encoded and stored in the DRAM (IC72).
- R6. The signals are sequentially taken from the DRAM (IC72) and sent theback to the MD LSI (IC3), where they are ACIRC-processed and EFM-modulated and then output from pin 73 to the magnetic head.
- R7. The magnetic disc records the signals onto the disc by magnetizing the magnetic film on the surface of the disc. During recording the laser diode emits its laser beam in order to raise the temperature to the Curie temperature\*4 that is required to magnetize the magnetic film. For this reason, the optical power of the laser diode is higher during recording than during playback.
- Although the disc revolves at a speed fast enough to write the signals without compression, the recording signals are compressed in order to reduce the data volume. As a result, the signals are written intermittently rather than continuously (the recording signals are intermittently sent to the magnetic head).

### Control

- C1. Performs the necessary controls for each operation during playback and recording and for writing of the UTOC\*5 at the end of recording.
- The information written in the UTOC includes the recorded track numbers and their addresses, text data, etc.
- C2. Performs the necessary displays of the text data recorded on the disc and for each operation.
- The system is designed for integrated operation, so that the system control IC (IC10) on the MD servo PCB and the system control IC (IC901) for the component system mutually exchange data (communicating).

### Clock

- The controls of the playback signal, recording signals, and of the 4-channel driver IC (IC1: AN8772) all function using the clock on the MD LSI as the master clock.
- The A/D-D/A converter (IC601) functions by using the clock signal of the MD LSI as the master clock and frequency-sampling that signal 384 times via the clock generator (IC501: TC9246).

Block Diagram

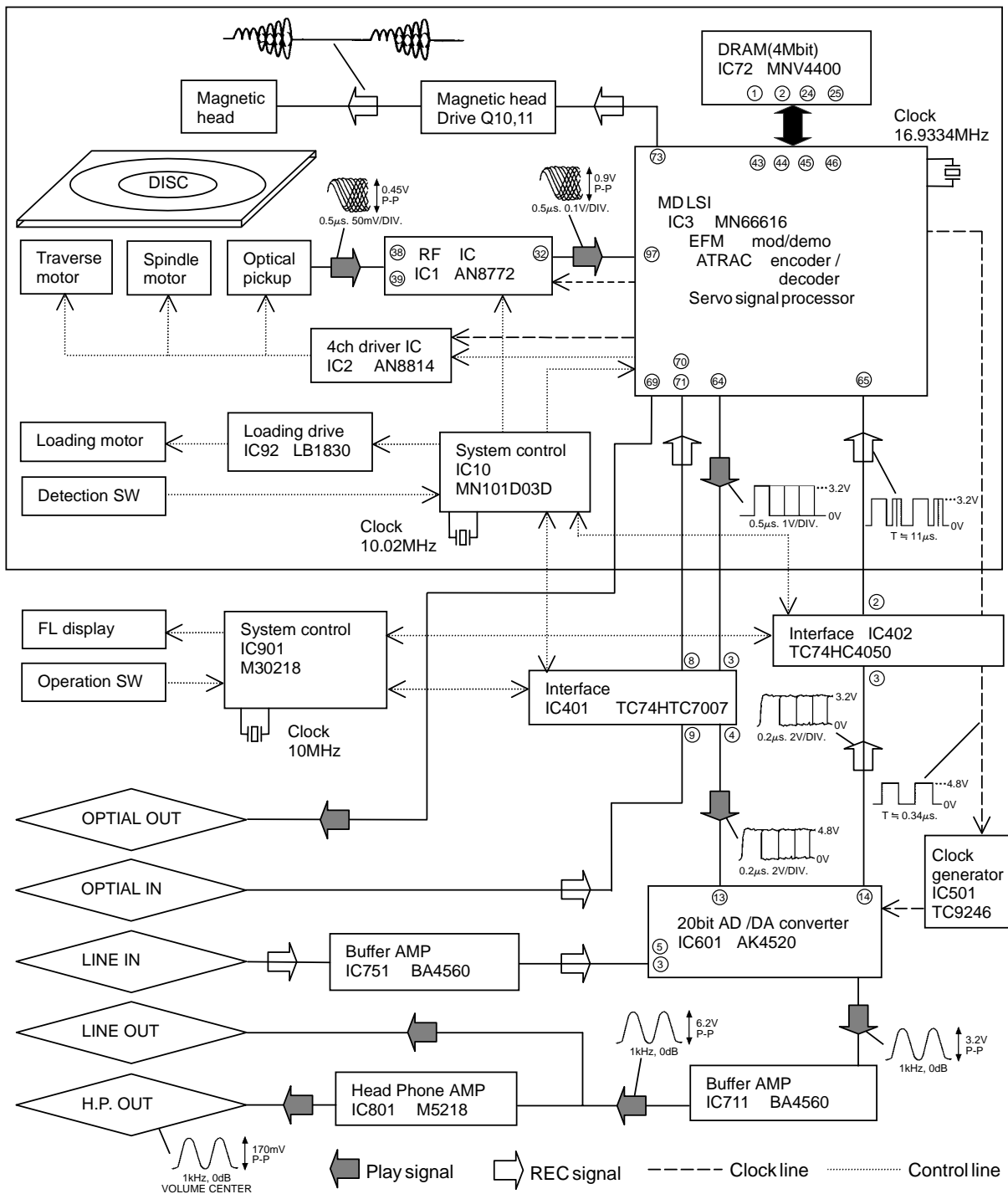

\*1 Kerr effect

A phenomenon in which the polarization plane of laser light reflected from a material shifts in one of two directions depending upon its "plus" or "minus" magnetic polarization.

\*2 ACIRC ..... Add on interleave CIRC

The aim of Add-on interleave is to improve the resistivity in CD-ROM decoder from the burst error on the disc.

\*3 ATRAC ..... Adaptive Transform Acoustic Coding

The digital data compressing system developed for MiniDisc in which audio signals can be reproduced with only about 1/5<sup>th</sup> in the data normally required for high fidelity reproduction

\*4 Curie temperature

The temperature at which magnetism of a specific material dissipates. This temperature varies according to the material.

\*5 UTOC ..... User Table Of Contents

Found only on recordable MiniDiscs, this area contains subdata (track number, etc.) which can be rewritten by the user.

# Troubleshooting Guide for MD Servo Circuit

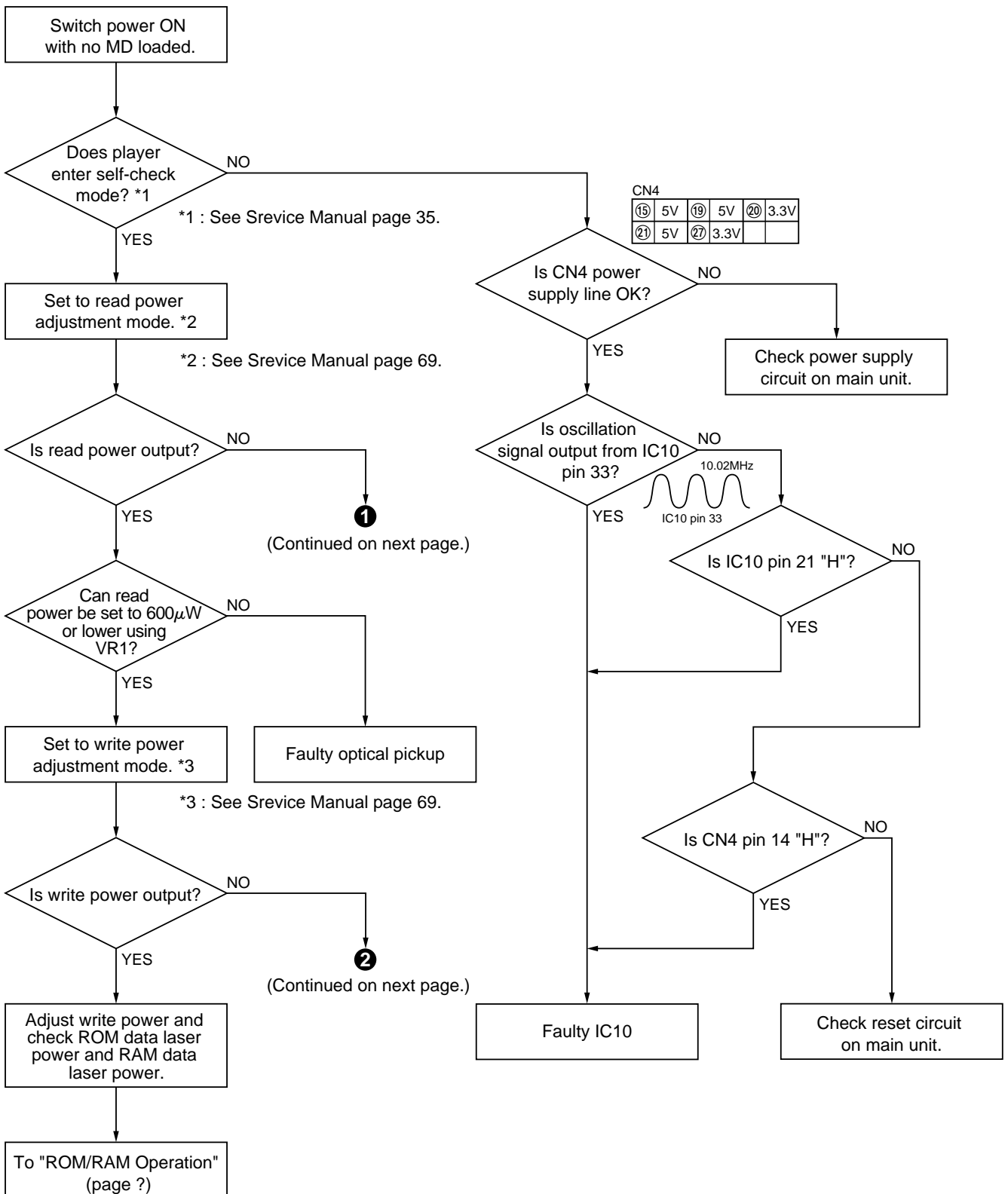

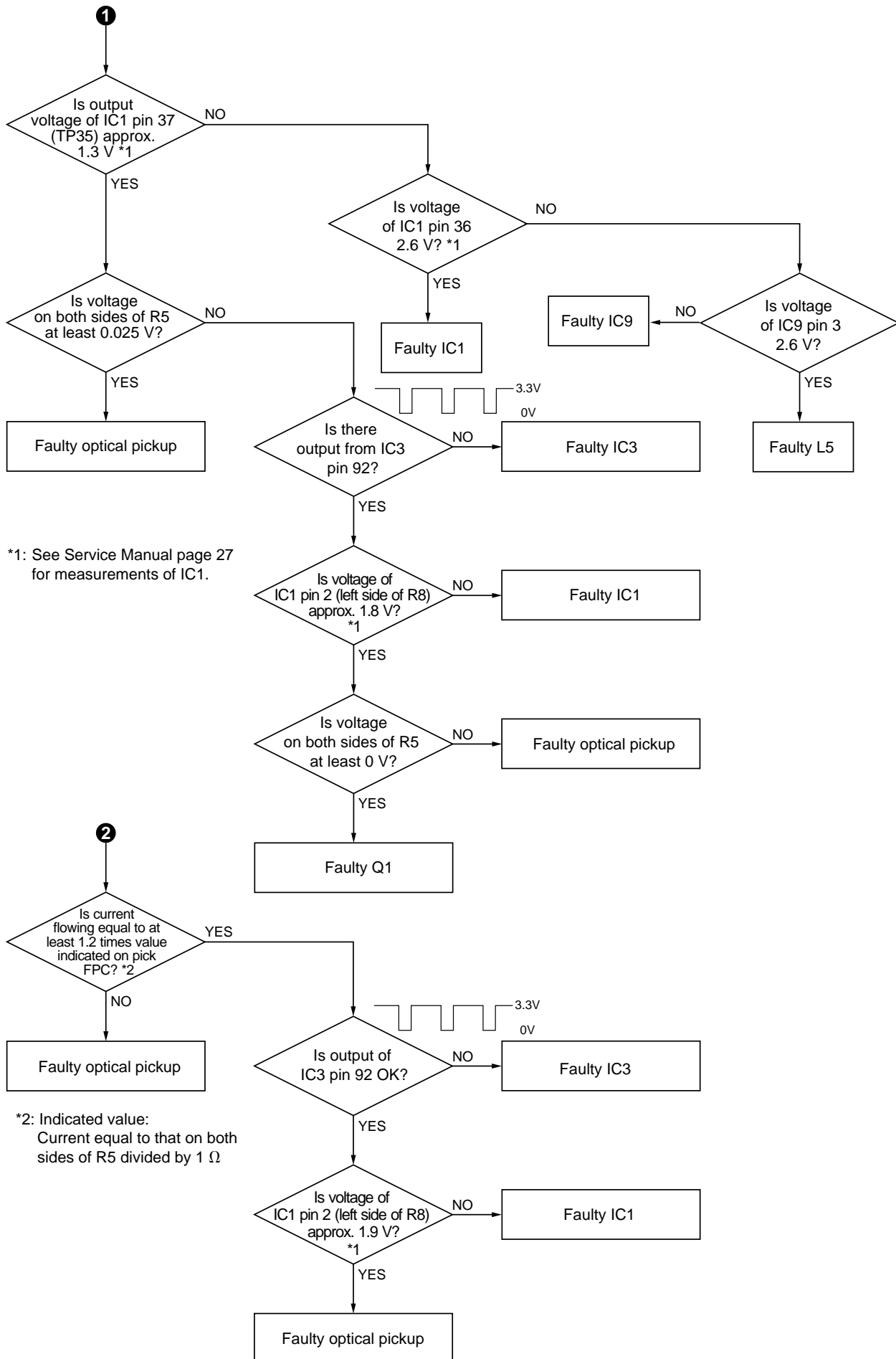

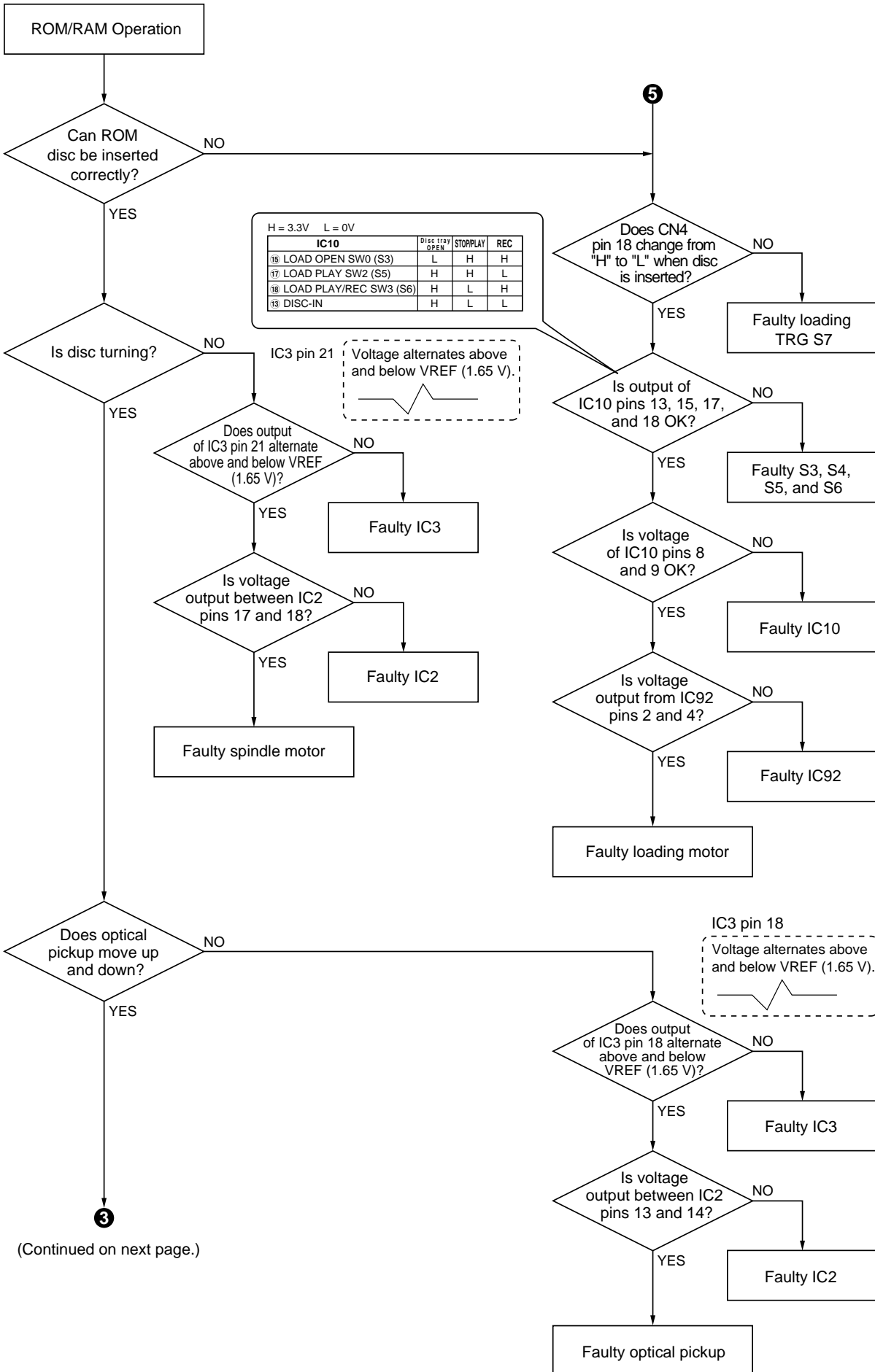

(Continued on next page.)

