

# Service Manual

Portable CD Player  
**SL-S310**

COMPACT  
**disc**  
DIGITAL AUDIO

**MASH\***  
multi-stage noise shaping

Please file and use this manual together with the service manual for Model No. SL-S360, Order No. AD9902009C1.

**Notes:** • This simplified service manual is provided to indicate the differences between the original No. SL-S360 (P) and the subsequent model No. SL-S310 (EB)(EG).



## Colour

(S) ..... Silver Type  
(A) ..... Blue Type

## Areas

(EB) ..... Great Britain.  
(EG) ..... Europe.

\* MASH is a trademark of NTT.

 <b>KQ1Q</b>	Door No. 3	 <b>51</b>
	Drop No. 8	
Customer: TECHNICA42		
Load: SPOWE1		
Model: AD9903068A2	Qty: 1	
Assemble at: 60	05/07/00	

## Traverse Deck: RAE0145Z Mechanism Series

## Specifications

### Audio

**No. of channels:** 2 channels (left and right, stereo)  
**Frequency response:** 20 to 20,000 Hz (+0.5 dB to -1.5 dB)  
**Output voltage:** 0.6 V (50 k $\Omega$ )  
diameter 3.5 stereo mini jack  
**S/N:** More than 94 dB  
(Anti-shock memory OFF)  
**Wow and flutter:** Below measurable limit  
**DA converter:** 1 bit, MASH\*  
**Headphone output level:** Max.9 mW+9 mW/16  $\Omega$  (adjustable)  
stereo mini jack diameter 3.5

### Pickup

**Light source:** Semiconductor laser  
**Wavelength:** 780 nm

### General

**Operational temperature range:** 0-40 degree (32-104 fahrenheit)  
**Rechargeable temperature range:** 5-40 degree (41-104 fahrenheit)  
**Power supply:** DC 4.5 V  
**Power consumption:** Anti-shock memory OFF/ON  
**AC adaptor:** 3.5 W / 3.6 W  
**Battery (DC 3V):** 0.4 W / 0.4 W  
**When recharging:** 4.6 W

### Playing time:

(When used in hold mode, at 25 degree (77 fahrenheit) temperature and on flat and stable surface.)

### Battery used:

Anti-shock memory OFF/ON

**Panasonic Alkaline dry cell batteries (LR6, 2pcs.);**

Approx. 22 h / 25 h

**Optional Rechargeable batteries (P-3GAVE(T)/2B);**

Approx. 10 h / 11 h

The play time may be less depending on the operating conditions.

### Recharging time:

**P-3GAVE(T)/2B;** Approx. 5 h

### Dimensions (W x H x D):

128 x 25.8 x 144 mm

### Weight:

257 g with batteries

212 g without batteries

**Notes:** Specifications are subject to change without notice.  
Weight and dimensions are approximate.

## ⚠ WARNING

This service information is designed for experienced repair technicians only and is not designed for use by the general public. It does not contain warnings or cautions to advise non-technical individuals of potential dangers in attempting to service a product. Products powered by electricity should be serviced or repaired only by experienced professional technicians. Any attempt to service or repair the product or products dealt with in this service information by anyone else could result in serious injury or death.

**Panasonic**<sup>®</sup>

© 1999 Matsushita Electric Industrial Co., Ltd.  
All rights reserved. Unauthorized copying and distribution is a violation of law.

## ■ Precaution of Laser Diode

**CAUTION:** This product utilizes a laser diode with the unit turned "on", invisible laser radiation is emitted from the pick up lens.  
Wave length: 780 nm  
Maximum output radiation power from pick up: 100  $\mu$ W/VDE

Laser radiation from the pick up unit is safety level, but be sure the followings:

1. Do not disassemble the pick up unit, since radiation from exposed laser diode is dangerous.
2. Do not adjust the variable resistor on the pick up unit. It was already adjusted.
3. Do not look at the focus lens using optical instruments.
4. Recommend not to look at pick up lens for a long time.

**ACHTUNG:** Dieses produkt enthält eine laserdioden. Im eingeschalteten zustand wird unsichtbare laserstrahlung von der lasereinheit adgestrahlt.  
Wellenlänge: 780 nm  
Maximale strahlungsleistung der lasereinheit: 100  $\mu$ W/VDE

Die strahlung an der lasereinheit ist ungefährlich, wenn folgende punkte beachtet werden:

1. Die lasereinheit nicht zerlegen, da die strahlung an der freigelegten laserdioden gefährlich ist.
2. Den werksseitig justierten einstellregler der lasereinheit nicht verstellen.
3. Nicht mit optischen instrumenten in die fokussierlinse blicken.
4. Nicht über längere zeit in die fokussierlinse blicken.



DANGER	INVISIBLE LASER RADIATION WHEN OPEN AND INTERLOCK DEFEATED. AVOID DIRECT EXPOSURE TO BEAM.	(Inside of product)
ADVARSEL	USYNLIG LASERSTRÅLING VED ÅBNING, NÅR SIKKERHEDSAFBRYDERE ER UDE AF FUNKTION. UNDGÅ UDSÆTTELSE FOR STRÅLING.	(Indersiden af apparatet)
VARO!	AVATTAESSA JA SUOJALUKITUS OHITETTAESSA OLET ALTIINA NÄKYMÄTÖNTÄ LASERSÄTELYLLE. ÄLÄ KATSO SÄTEESEEN.	(Tuotteen sisällä)
VARNING	OSYNLIG LASERSTRÅLING NÅR DENNA DEL ÅR ÖPPNAD OCH SPÅRREN ÅR URKOPPLAD. BETRÄKTA EJ STÅRÅLEN.	(Apparatens insida)
ADVARSEL	USYNLIG LASERSTRÅLING NÅR DEKSEL ÅPNES OG SIKKERHEDSLÅS BRÆYTES. UNNGÅ EKSPONERING FOR STRÅLEN.	(Produktets innside)
VORSICHT	UNSICHTBARE LASERSTRÄHLUNG, WENN ABDECKUNG GEÖFFNET UND SICHERHEITSVERRIEGELUNG ÜBERBRÜCKT. NICHT DEM STRAHL AUSSETZEN.	(Im Inneren des Gerätes)

## ■ Schematic Diagram

(This schematic diagram may be modified at any time with the development of new technology.)

### Notes:

- S201 : Laser ON/OFF switch in "OFF" position.  
(It turns "ON" with disc holder closed.)
- S202 : Rest detector switch in "OFF" position.  
(It turns "ON" when optical pickup comes to innermost periphery.)
- S301 : Play/pause (▶ ||) switch.
- S302 : Stop/operation off (■ POWER OFF) switch.
- S303, 304: Skip/search (S303: ▶▶▶, ▶▶▶ S304: ◀◀◀, ◀◀◀) switches.
- S305 : Repeat (REP) switch.
- S306 : Memory/recall (MEMORY/RECALL) switch.
- S307 : S-XBS Selector (S-XBS) switch.
- S308 : Anti-shock (A.SHOCK) switch.
- S309 : Play mode selector (MODE) in "NORMAL" position.  
(RANDOM ↔ NORMAL ↔ RESUME)
- S310 : Hold (HOLD) switch in "OFF" position.
- VR11 : Power supply voltage adjustment VR.
- VR701-1, VR701-2: Volume control VR.

- The voltage value and waveforms are the reference voltage of this measured by DC electronic voltmeter (high impedance) and oscilloscope on the basis of GND terminal (DC IN Jack). Accordingly, there may arise some errors in the voltage values and waveforms depending upon the internal impedance of the tester or measuring unit.
- The parenthesized is the voltage for test disc (1kHz, L+R, 0 dB) in play mode, and the other, for no disc in stop mode.
- AC adaptor is used for power supply.
- Signal line

→ : Positive voltage line.

→ : Audio signal line.

- Important safety notice:

Components identified by  $\Delta$  mark have special characteristics important for safety. Furthermore, special parts which have purposes of fire-retardant (resistors), high-quality sound (capacitors), low-noise (resistors), etc. are used. When replacing any of components, be sure to use only manufacture's specified parts shown in the parts list.

### Caution!

- IC and LSI are sensitive to static electricity.
- Secondary trouble can be prevented by taking care during repair.
- Cover the parts boxes made of plastics with aluminum foil.
- Ground the soldering iron.
- Put a conductive mat on the work table.
- Do not touch the pins of IC or LSI with fingers directly.



→ POSITIVE VOLTAGE LINE

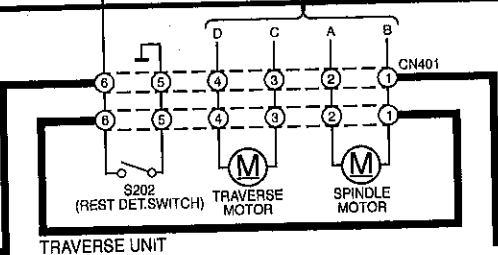
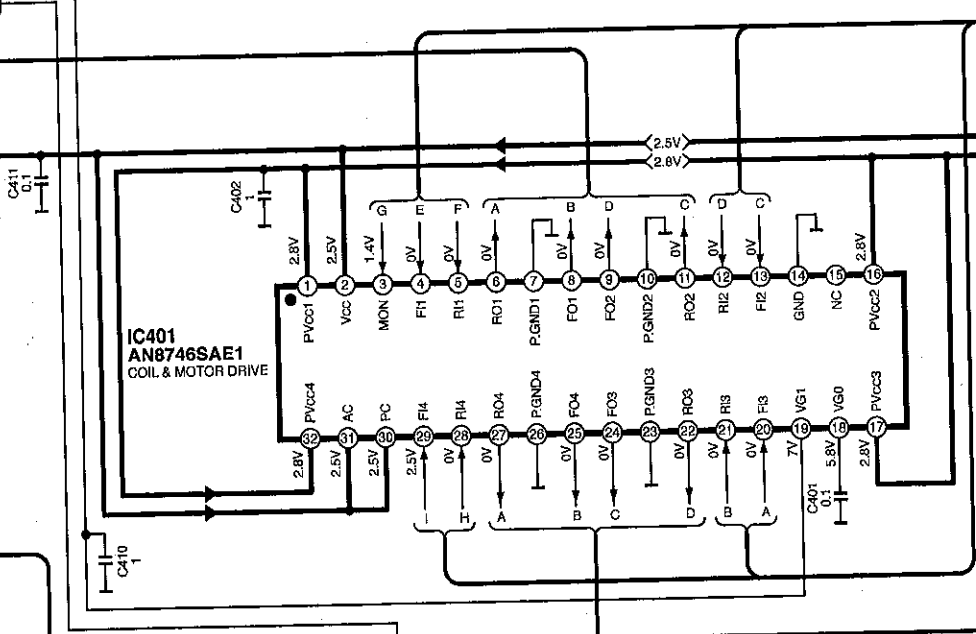
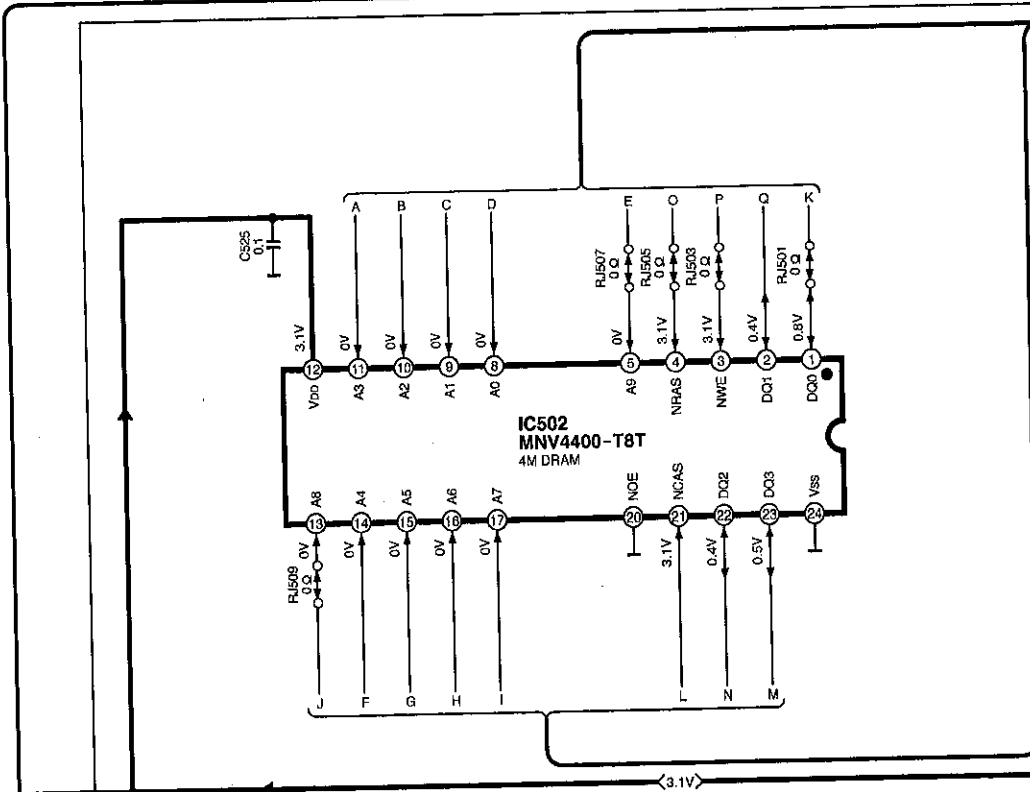

→ : POSITIVE VOLTAGE LINE    ⇨ : AUDIO SIGNAL LINE

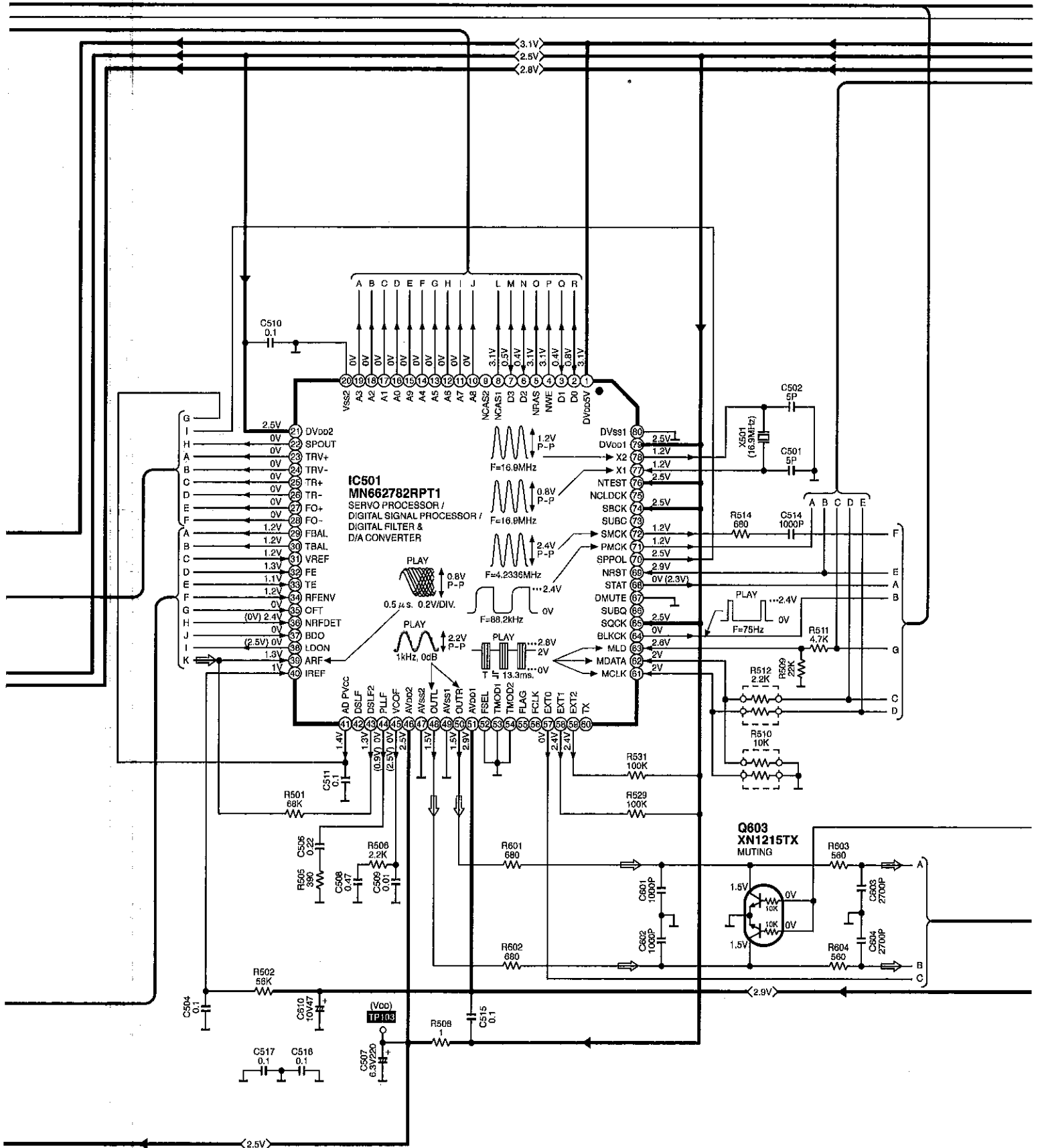

→ : POSITIVE VOLTAGE LINE

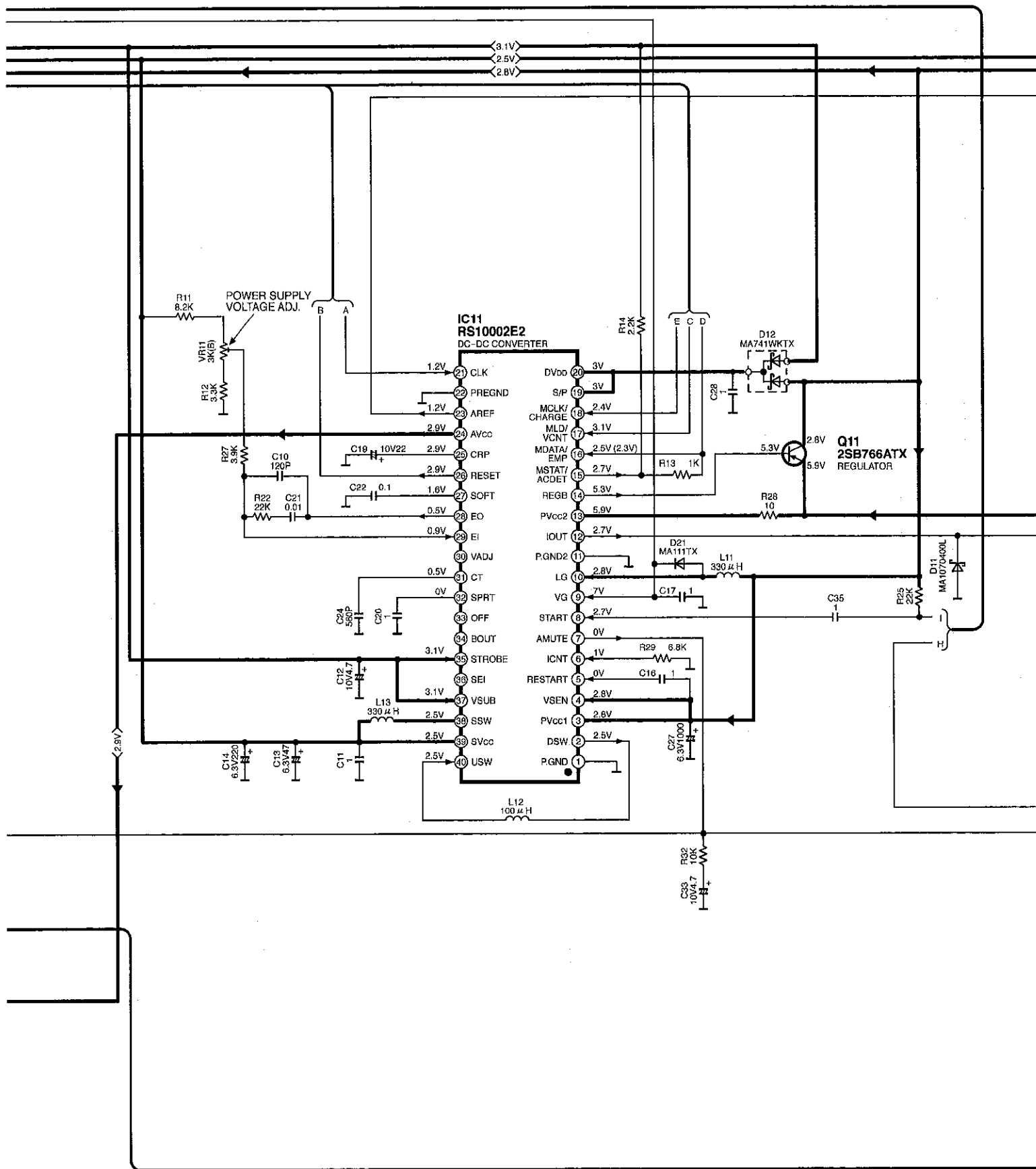



# Printed Circuit Board and Wiring Connection Diagram

• This circuit board diagram may be modified at any time with the development of new technology.

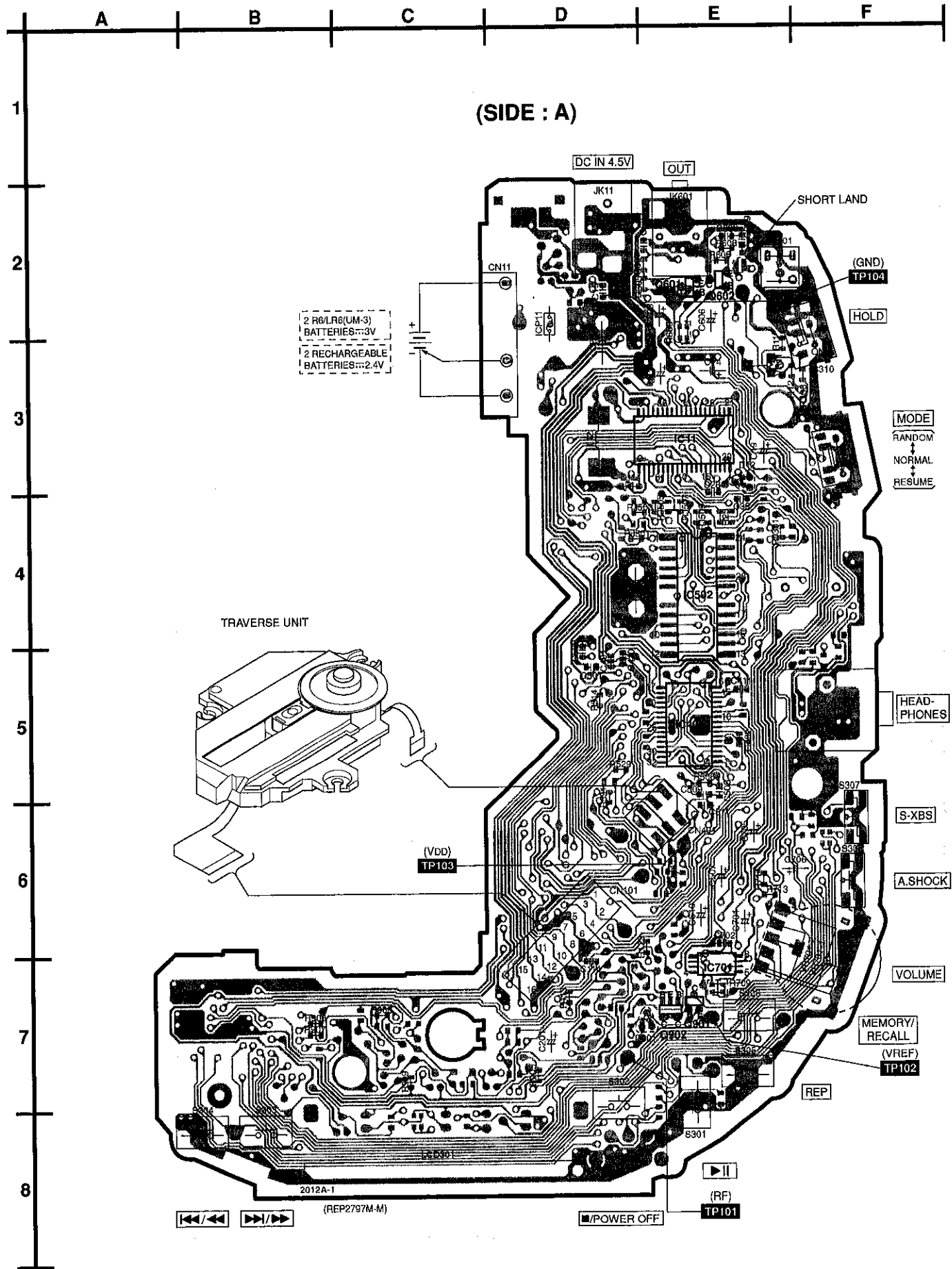



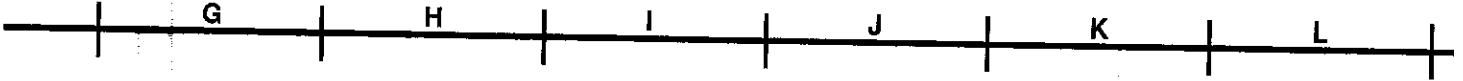

(SIDE : B)

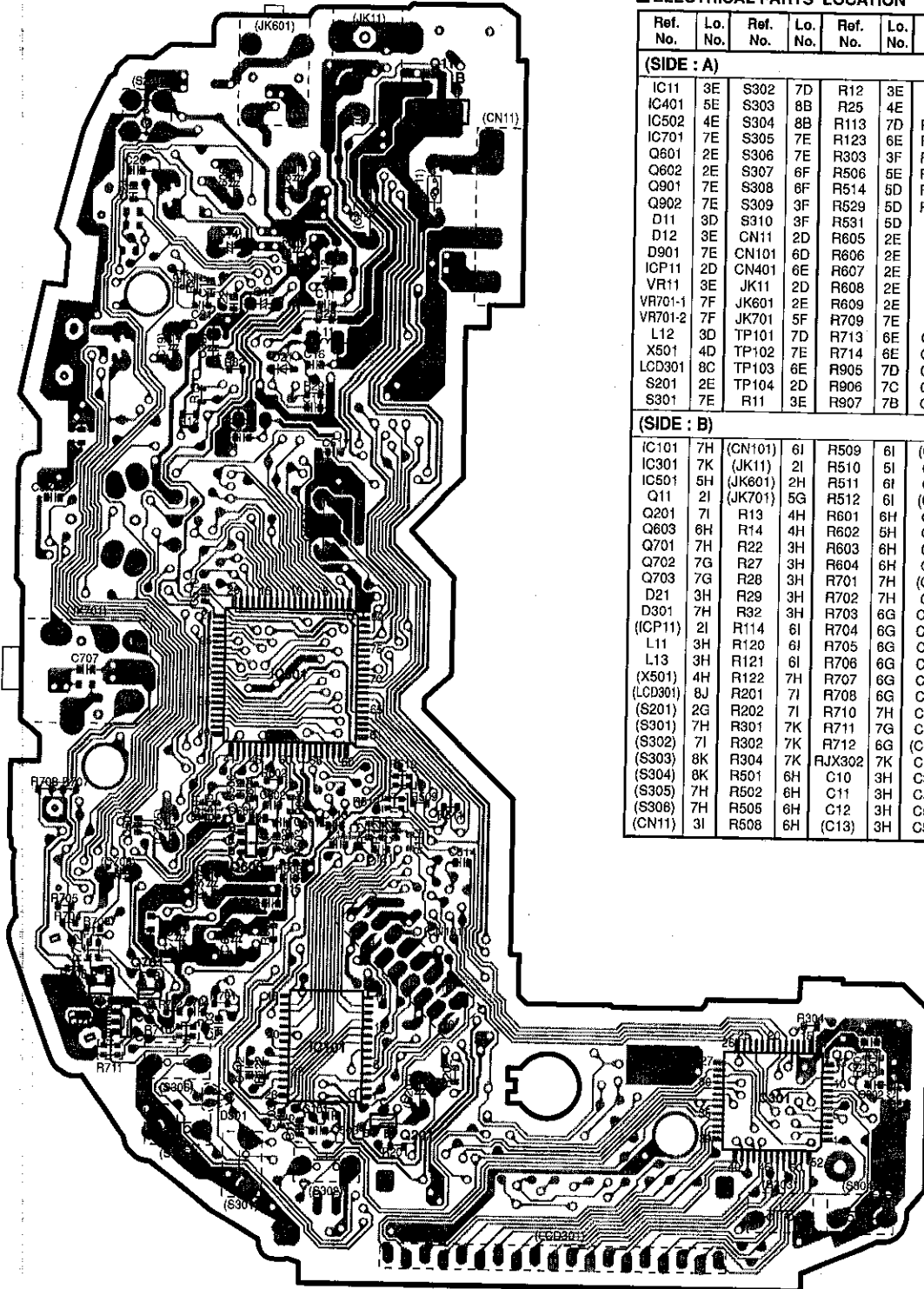

■ ELECTRICAL PARTS LOCATION

Ref. No.	Lo. No.	Ref. No.	Lo. No.	Ref. No.	Lo. No.	Ref. No.	Lo. No.	Ref. No.	Lo. No.
<b>(SIDE : A)</b>									
IC11	3E	S302	7D	R12	3E	R908	7B	C411	5E
IC401	5E	S303	8B	R25	4E	R909	7C	C501	5D
IC502	4E	S304	8B	R113	7D	RJ301	4E	C502	5D
IC701	7E	S305	7E	R123	6E	RJ501	4D	C507	6E
Q601	2E	S306	7E	R303	3F	RJ503	4D	C508	5E
Q602	2E	S307	6F	R506	5E	RJ505	4E	C509	5E
Q901	7E	S308	6F	R514	5D	RJ507	4E	C511	6E
Q902	7E	S309	3F	R529	5D	RJ509	4E	C605	2E
D11	3D	S310	3F	R531	5D	C13	3E	C606	2E
D12	3E	CN11	2D	R605	2E	C14	3E	C607	2E
D901	7E	CN101	6D	R606	2E	C15	2D	C608	2E
ICP11	2D	CN401	6E	R607	2E	C19	3E	C609	2E
VR11	3E	JK11	2D	R608	2E	C27	3D	C610	6E
VR701-1	7F	JK601	2E	R609	2E	C28	4E	C701	6E
VR701-2	7F	JK701	5F	R709	7E	C35	4E	C702	6E
L12	3D	TP101	7D	R713	6E	C114	7D	C705	6E
X501	4D	TP102	7E	R714	6E	C201	7D	C706	6E
LC0301	8C	TP103	6E	R905	7D	C401	5D		
S201	2E	TP104	2D	R906	7C	C402	5E		
S301	7E	R11	3E	R907	7E	C410	5D		
<b>(SIDE : B)</b>									
IC101	7H	(CN101)	6I	R509	6I	(C14)	3H	(C507)	6H
IC301	7K	(JK11)	2I	R510	5I	C16	3H	C510	5H
IC501	5H	(JK601)	2H	R511	6I	C17	4H	C514	6I
Q11	2I	(JK701)	5G	R512	6I	(C19)	3H	C515	6H
Q201	7I	R13	4H	R601	6H	C20	2G	C516	6H
Q603	6H	R14	4H	R602	6H	C21	3H	C517	4H
Q701	7H	R22	3H	R603	5H	C22	3H	C525	4H
Q702	7G	R27	3H	R604	6H	C24	2G	C601	6H
Q703	7G	R28	3H	R701	7H	(C27)	3I	C602	6H
D21	3H	R29	3H	R702	7H	C33	3H	C603	6H
D301	7H	R32	3H	R703	6G	C101	7I	C604	6H
(ICP11)	2I	R114	6I	R704	6G	C103	7H	(C605)	2H
L11	3H	R120	6I	R705	6G	C111	6I	(C606)	2H
L13	3H	R121	6I	R706	6G	C112	7H	(C610)	6H
(X501)	4H	R122	7H	R707	6G	C113	6I	(C701)	6H
(LC0301)	8J	R201	7I	R708	6G	C115	7H	C703	7H
(S201)	2G	R202	7I	R710	7H	C120	6I	C704	7H
(S301)	7H	R301	7K	R711	7G	C121	6I	(C705)	6H
(S302)	7I	R302	7K	R712	6G	(C201)	7I	(C706)	6G
(S303)	8K	R304	7K	RJX302	7K	C301	7K	C707	5G
(S304)	8K	R501	6H	C10	3H	C302	7K	CJX701	4G
(S305)	7H	R502	6H	C11	3H	C503	7H		
(S306)	7H	R505	6H	C12	3H	C504	6H		
(CN11)	3I	R508	6H	(C13)	3H	C506	6H		

## ■ Replacement Parts List

### Notes: \* Important safety notice:

Components identified by  $\Delta$  mark have special characteristics important for safety.

Furthermore, special parts which have purposes of fire-retardant (resistors), high-quality sound (capacitors), low-noise (resistors), etc. are used.

When replacing any of components, be sure to use only manufacture's specified parts shown in the parts list.

\* The parenthesized indications in the Remarks columns specify the areas. (Refer to the cover page for area.)

\* ALL parts are supplied by MESA.

\* The marks in Remarks indicates as follow.

• Language of operating instructions.

<IA>: English, Spanish, Swedish, German, Italian, French

<IB>: Dutch, Danish, Russian, Polish, Czech

<IC>: English

• Specify the colours.

[A] : Blue Type

[S] : Silver Type

Ref.No.	Part No.	Part Name & Description	Pcs	Remarks
$\Delta$ A1	RFEA403B-S	AC ADAPTOR	1	(EB)
$\Delta$ A1	RFEA401E-3S	AC ADAPTOR	1	(EG)
A2	RFEV324P-KS	INSIDEPHONE	1	
A3	RQT4836-E	OPERATING INSTRUCTIONS	1	(EG)<IA>
A3	RQT4838-H	OPERATING INSTRUCTIONS	1	(EG)<IB>
A3	RQT4841-B	OPERATING INSTRUCTIONS	1	(EB)<IC>
A4	RQA0117	WARRANTY CARD	1	
A5	RQCB0169	SERVICE CENTER LIST	1	
C10	ECUV1H121JCV	50V 120P	1	
C11	ECUVNA105ZFV	10V 1U	1	
C12	RCST1AY475RE	10V 4.7U	1	
C13	RCE0JSC470IX	6.3V 47U	1	
C14	RCE0JKA221IG	6.3V 220U	1	
C15	ECUZNC104ZFV	16V 0.1U	1	
C16,17	ECUVNA105ZFV	10V 1U	2	
C19	ECEA1AKS220	10V 22U	1	
C20	ECUVNA105ZFV	10V 1U	1	
C21	ECUV1E103KBV	25V 0.01U	1	
C22	ECUZNC104ZFV	16V 0.1U	1	
C24	ECUV1H561KBV	50V 560P	1	
C27	RCE0JRC102BG	6.3V 1000U	1	
C28	ECUVNA105ZFV	10V 1U	1	
C33	RCST1AY475RE	10V 4.7U	1	
C35	ECUVNJ105KBV	63V 1U	1	
C101	ECUV1C104KBV	16V 0.1U	1	
C103	ECUVNE223KBV	25V 0.022U	1	
C111	ECUVNE223KBV	25V 0.022U	1	
C112	ECUV1H221KBV	50V 220P	1	
C113,14	ECUZNC104ZFV	16V 0.1U	2	
C115	ECUVNE223KBV	25V 0.022U	1	
C120	ECUV1H152KBV	50V 1500P	1	
C121	ECUV1H121JCV	50V 120P	1	
C201	RCE1AKA470IG	10V 47U	1	
C301,02	ECUVNA105ZFV	10V 1U	2	
C401	ECUZNC104ZFV	16V 0.1U	1	
C402	ECUVNA105ZFV	10V 1U	1	
C410	ECUVNA105ZFV	10V 1U	1	
C411	ECUZNC104ZFV	16V 0.1U	1	
C501,02	ECUV1H050CCV	50V 5P	2	
C503	ECUV1H561KBV	50V 560P	1	
C504	ECUZNC104ZFV	16V 0.1U	1	
C506	ECUVNA224KBV	10V 0.22U	1	
C507	RCE0JKA221IG	6.3V 220U	1	
C508	ECUV0J474KBV	6.3V 0.47U	1	
C509	ECUV1E103KBV	25V 0.01U	1	
C510	ECUZNC104ZFV	16V 0.1U	1	
C511	ECUZNC104ZFV	16V 0.1U	1	
C514	ECUV1H102KBV	50V 1000P	1	
C515-17	ECUZNC104ZFV	16V 0.1U	3	
C525	ECUZNC104ZFV	16V 0.1U	1	
C601,02	ECUV1H102KBV	50V 1000P	2	
C605,06	ECEA1CKS100	16V 10U	2	
C607,08	ECUV1H681KBV	50V 680P	2	

Ref.No.	Part No.	Part Name & Description	Pcs	Remarks
C609	ECUZNC104ZFV	16V 0.1U	1	
C610	RCE1AKA470IG	10V 47U	1	
C701	RCE1AKA470IG	10V 47U	1	
C702	ECUZNC104ZFV	16V 0.1U	1	
C703,04	ECUVNJ105KBV	63V 1U	2	
C705,06	ECA0JAK221XH	6.3V 220U	2	
C707	ECUZNC104ZFV	16V 0.1U	1	
CJX701	ECUV1H101KCV	50V 100P	1	
CN11	RJH8303	BATT.TERMINAL	1	
CN101	RJS2A4716M1	CONNECTOR(16P)	1	
CN401	RJS2A5106T1	CONNECTOR(6P)	1	
D11	MA1070400L	DIODE	1	
D12	MA741WKTX	DIODE	1	
D21	MA111TX	DIODE	1	
D301	MA142WKTX	DIODE	1	
D901	MA142WKTX	DIODE	1	
IC11	RS10002E2	IC	1	
IC101	AN8839NSBE1	IC	1	
IC301	SC502171CPB	IC	1	
IC401	AN8746SAE1	IC	1	
IC501	MN682782RPT1	IC	1	
IC502	MNV4400-T8T	IC	1	
IC701	NJU7082BVTE1	IC	1	
$\Delta$ ICP11	UNH000700A	IC PROTECTOR	1	
JK11	RJJ43K09-C	JACK,DC IN	1	
JK601	RJJD3S5ZB-C	JACK,OUT(AUDIO)	1	
JK701	RJJ33TK07-C	JACK,HEADPHONES	1	
L11	RLQU931KT-W	COIL	1	
L12	RLQS101KT1-T	COIL	1	
L13	RLQU931KT-W	COIL	1	
P1	RPK1223	PACKING CASE	1	[A]
P1	RPK1149	PACKING CASE	1	[S]
P2	RPQ0753	SPACER	1	
P3	RPQ0836-1	PAD	1	
P4	RPF0046	PROTECTION BAG	1	(EG)
P5	RPF0111	PROTECTION COVER	1	
PCB1	REP2797M-M	P.C.B. ASS'Y	1	
Q11	2SB766ATX	TRANSISTOR	1	
Q201	MSB709RST1	TRANSISTOR	1	
Q601,02	2SD1328QRSTX	TRANSISTOR	2	
Q603	XN1215TX	TRANSISTOR	1	
Q701,02	2SD1328QRSTX	TRANSISTOR	2	
Q703	XN1210TX	TRANSISTOR	1	
Q901	DTA114YUA106	TRANSISTOR	1	
Q902	XN1210TX	TRANSISTOR	1	
R11	ERJ3GEYJ822V	1/16W 8.2K	1	
R12	ERJ3GEYJ932V	1/16W 3.3K	1	
R13	ERJ3GEYJ102Z	1/16W 1K	1	
R14	ERJ3GEYJ222V	1/16W 2.2K	1	
R22	ERJ3GEYJ223V	1/16W 22K	1	
R25	ERJ3GEYJ223V	1/16W 22K	1	
R27	ERJ3GEYJ392V	1/16W 3.9K	1	
R28	ERJ3GEYJ100V	1/16W 10	1	
R29	ERJ3GEYJ682V	1/16W 6.8K	1	
R32	ERJ3GEYJ103Z	1/16W 10K	1	
R113,14	ERJ3GEYJ330V	1/16W 33	2	
R120	ERJ3GEYJ103Z	1/16W 10K	1	
R121,22	ERJ3GEYJ124V	1/16W 120K	2	
R123	ERJ3GEYJ473V	1/16W 47K	1	
R201	ERJ3GEYJ2R2V	1/16W 2.2	1	
R202	ERJ3GEYJ223V	1/16W 22K	1	
R301	ERJ3GEYJ392V	1/16W 3.9K	1	
R302	ERJ3GEYJ104Z	1/16W 100K	1	
R303	ERJ3GEYJ102Z	1/16W 1K	1	
R304	ERJ3GEYJ105V	1/16W 1M	1	
R501	ERJ3GEYJ683V	1/16W 68K	1	
R502	ERJ3GEYJ563V	1/16W 56K	1	

Ref.No.	Part No.	Part Name & Description	Pcs	Remarks
R505	ERJ3GEYJ391V	1/16W 390	1	
R506	ERJ3GEYJ222V	1/16W 2.2K	1	
R508	ERJ3GEYJ1R0V	1/16W 1	1	
R509	ERJ3GEYJ223V	1/16W 22K	1	
R510	EXBV4V103JV	1/32W 10K	1	
R511	ERJ3GEYJ472V	1/16W 4.7K	1	
R512	EXBV4V222JV	1/32W 2.2K	1	
R514	ERJ3GEYJ681V	1/16W 680	1	
R529	ERJ3GEYJ104Z	1/16W 100K	1	
R531	ERJ3GEYJ104Z	1/16W 100K	1	
R601,02	ERJ3GEYJ681V	1/16W 680	2	
R603,04	MCR03PZH561	1/16W 560	2	
R605,06	ERJ3GEYJ473V	1/16W 47K	2	
R607,08	ERJ3GEYJ102Z	1/16W 1K	2	
R609	EXBV4V332JV	1/32W 3.3K	1	
R701,02	ERJ3GEYJ473V	1/16W 47K	2	
R703,04	ERJ3GEYJ150V	1/16W 15	2	
R705,06	ERJ3GEYJ1R5V	1/16W 1.5	2	
R707,08	ERJ3GEYJ472V	1/16W 4.7K	2	
R709	EXBV4V473JV	1/32W 47K	1	
R710	EXBV4V183JV	1/32W 18K	1	
R711	EXBV4V223JV	1/32W 22K	1	
R712	EXBV4V331JV	1/32W 330	1	
R713,14	ERJ3GEY0R00V	1/16W 0	2	
R905	ERJ3GEYJ473V	1/16W 47K	1	
R906	ERJ3GEYJ823V	1/16W 82K	1	
R907	ERJ3GEYJ123V	1/16W 12K	1	
R908	ERJ3GEYJ393V	1/16W 39K	1	
R909	ERJ3GEYJ473V	1/16W 47K	1	
RJ301	ERJ3GEY0R00V	CHIP JUMPER	1	
RJ501	ERJ3GEY0R00V	CHIP JUMPER	1	
RJ503	ERJ3GEY0R00V	CHIP JUMPER	1	
RJ505	ERJ3GEY0R00V	CHIP JUMPER	1	
RJ507	ERJ3GEY0R00V	CHIP JUMPER	1	

Ref.No.	Part No.	Part Name & Description	Pcs	Remarks
RJ509	ERJ3GEY0R00V	CHIP JUMPER	1	
RJX302	ERJ3GEY0R00V	CHIP JUMPER	1	
S201	ESE11SV6	SW,LASER ON/OFF	1	
S301-06	EVQ11G05R	SW,PUSH	6	
S307,08	EVQPUM02K	SW,PUSH	2	
S309	RSS3A007-1A	SW,MODE	1	
S310	RSS2A010-1A	SW,HOLD	1	
VR11	RRN3A05B33WL	V.R. POWER SUPPLY VOLT.	1	
VR701	EVUTUFB11C54	V.R. VOLUME	1	
X501	RSXZ16M9M01T	OSCILLATOR	1	

### ■ Replacement Parts List (Cabinet Parts)

Ref. No.	Change of Parts No.		Part Name & Description	Remarks
	SL-S360(P)	➔ SL-S310(EB/EG)		
<b>CABINET PART(S)</b>				
1	RFKJLS360P-S	RFKJLS310EBS	BOTTOM CABINET ASS'Y	(EB)
		RFKJLS210EGS		(EG)
10	RYF0504-S	RYF0504A-S	CD LID ASS'Y	[S]
		RYF0504A-A		[A]

# ■ Packaging

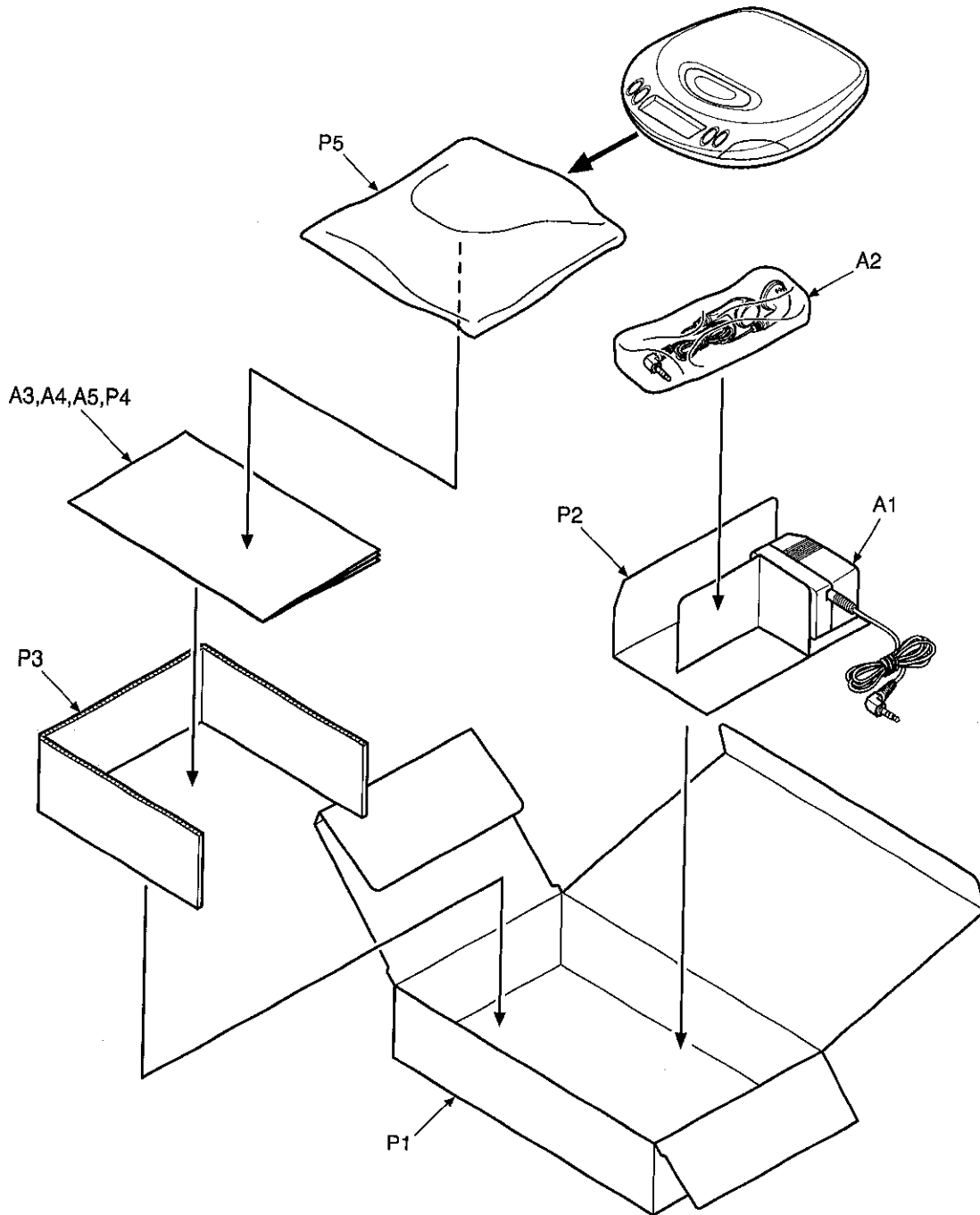

Ref.No.	Part No.	Part Name & Description	Pcs	Remarks
△ A1	RFEA403B-S	AC ADAPTOR	1	(EB)
△ A1	RFEA401E-3S	AC ADAPTOR	1	(EG)
A2	RFEV324P-KS	INSIDEPHONE	1	
A3	RQT4836-E	OPERATING INSTRUCTIONS	1	(EG)<IA>
A3	RQT4838-H	OPERATING INSTRUCTIONS	1	(EG)<IB>
A3	RQT4841-B	OPERATING INSTRUCTIONS	1	(EB)<IC>
A4	RQA0117	WARRANTY CARD	1	
A5	RQCB0169	SERVICE CENTER LIST	1	

Ref.No.	Part No.	Part Name & Description	Pcs	Remarks
P1	RPK1223	PACKING CASE	1	[A]
P1	RPK1149	PACKING CASE	1	[S]
P2	RPQ0753	SPACER	1	
P3	RPQ0836-1	PAD	1	
P4	RPF0046	PROTECTION BAG	1	(EG)
P5	RPF0111	PROTECTION COVER	1	