

YAMAHA

DDP-1

NATURAL SOUND DIGITAL PROCESSOR

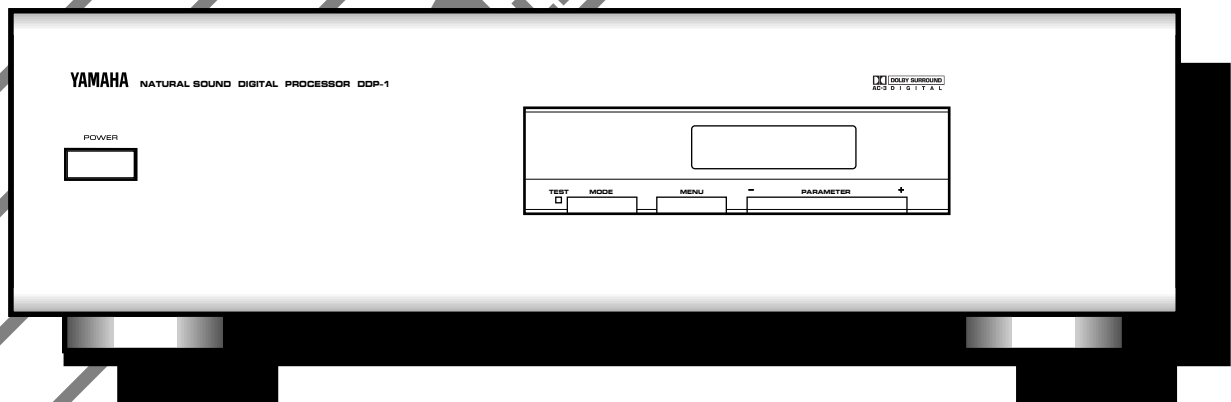

OWNER'S MANUAL

IMPORTANT!

Please record the serial number of this unit in the space below.

Serial No.:

The serial number is located on the rear of the unit. Retain this Owner's Manual in a safe place for future reference.

CONTENTS

Safety Instructions	2
Profile of This Unit	4
Speaker System Setup	5
Connections	6
Turning On/Off the Power of This Unit	8
Table of Functions	9
Adjustments Before Operation	10
Playing an AC-3 Source	14
Adjusting Output Levels	14
Adjusting Delays and Dynamic Range	16
Specifications	18
Troubleshooting	18
Block Diagram	19

SAFETY INSTRUCTIONS

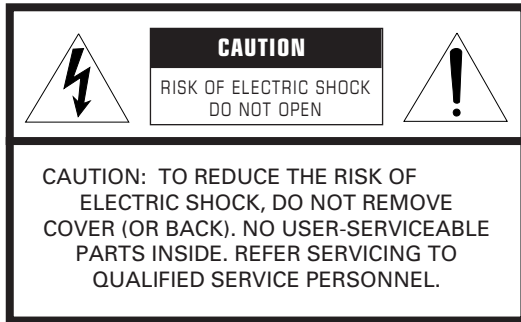

• Explanation of Graphical Symbols

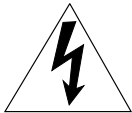

The lightning flash with arrowhead symbol, within an equilateral triangle, is intended to alert you to the presence of uninsulated "dangerous voltage" within the product's enclosure that may be of sufficient magnitude to constitute a risk of electric shock to persons.



The exclamation point within an equilateral triangle is intended to alert you to the presence of important operating and maintenance (servicing) instructions in the literature accompanying the appliance.



- 1 Read Instructions – All the safety and operating instructions should be read before the unit is operated.
- 2 Retain Instructions – The safety and operating instructions should be retained for future reference.
- 3 Heed Warnings – All warnings on the unit and in the operating instructions should be adhered to.
- 4 Follow Instructions – All operating and other instructions should be followed.
- 5 Water and Moisture – The unit should not be used near water – for example, near a bathtub, washbowl, kitchen sink, laundry tub, in a wet basement, or near a swimming pool, etc.
- 6 Carts and Stands – The unit should be used only with a cart or stand that is recommended by the manufacturer.
- 6A A unit and cart combination should be moved with care. Quick stops, excessive force, and uneven surfaces may cause the unit and cart combination to overturn.



- 7 Wall or Ceiling Mounting – The unit should be mounted to a wall or ceiling only as recommended by the manufacturer.
- 8 Ventilation – The unit should be situated so that its location or position does not interfere with its proper ventilation. For example, the unit should not be situated on a bed, sofa, rug, or similar surface, that may block the ventilation openings; or placed in a built-in installation, such as a bookcase or cabinet that may impede the flow of air through the ventilation openings.
- 9 Heat – The unit should be situated away from heat sources such as radiators, stoves, or other appliances that produce heat.
- 10 Power Sources – The unit should be connected to a power supply only of the type described in the operating instructions or as marked on the unit.
- 11 Power-Cord Protection – Power-supply cords should be routed so that they are not likely to be walked on or pinched by items placed upon or against them, paying particular attention to cords at plugs, convenience receptacles, and the point where they exit from the unit.
- 12 Cleaning – The unit should be cleaned only as recommended by the manufacturer.
- 13 Nonuse Periods – The power cord of the unit should be unplugged from the outlet when left unused for a long period of time.
- 14 Object and Liquid Entry – Care should be taken so that objects do not fall into and liquids are not spilled into the inside of the unit.
- 15 Damage Requiring Service – The unit should be serviced by qualified service personnel when:
 - A. The power-supply cord or the plug has been damaged; or
 - B. Objects have fallen, or liquid has been spilled into the unit; or
 - C. The unit has been exposed to rain; or
 - D. The unit does not appear to operate normally or exhibits a marked change in performance; or
 - E. The unit has been dropped, or the cabinet damaged.
- 16 Servicing – The user should not attempt to service the unit beyond those means described in the operating instructions. All other servicing should be referred to qualified service personnel.
- 17 Power Lines – An outdoor antenna should be located away from power lines.
- 18 Grounding or Polarization – Precautions should be taken so that the grounding or polarization is not defeated.

Caution: Read this before operating your unit

- 1 To assure the finest performance, please read this manual carefully. Keep it in a safe place for future reference.
- 2 Install this unit in a cool, dry, clean place – away from windows, heat sources, sources of excessive vibration, dust, moisture and cold. Avoid sources of humming (transformers, motors). To prevent fire or electrical shock, do not expose the unit to rain and water.
- 3 Do not operate the unit upside-down. It may overheat, possibly causing damage.
- 4 Never open the cabinet. If something drops into the set, contact your dealer.
- 5 Do not use force on switches, controls or connection wires. When moving the unit, first disconnect the power plug and the wires connected to other equipment. Never pull the wires themselves.
- 6 Do not attempt to clean the unit with chemical solvents; this might damage the finish. Use a clean, dry cloth.
- 7 To prevent lightning damage, pull out the power cord and remove the antenna cable during an electrical storm.
- 8 **When not planning to use this unit for long periods of time (ie., vacation, etc.), disconnect the AC power plug from the wall outlet.**
- 9 Be sure to read the “TROUBLESHOOTING” section regarding common operating errors before concluding that the unit is faulty.
- 10 AC outlet
Do not connect audio equipment to the AC outlet on the rear panel if that equipment requires more power than the outlet is rated to provide.

The apparatus is not disconnected from the AC power source as long as it is connected to the wall outlet, even if the apparatus itself is turned off.

FCC INFORMATION (for US customers only)

1. IMPORTANT NOTICE : DO NOT MODIFY THIS UNIT!

This product, when installed as indicated in the instructions contained in this manual, meets FCC requirements. Modifications not expressly approved by Yamaha may void your authority, granted by the FCC, to use the product.

2. IMPORTANT : When connecting this product to accessories and/or another product use only high quality shielded cables. Cable/s supplied with this product MUST be used. Follow all installation instructions. Failure to follow instructions could void your FCC authorization to use this product in the USA.

3. NOTE : This product has been tested and found to comply with the requirements listed in FCC Regulations, Part 15 for Class “B” digital devices. Compliance with these requirements provides a reasonable level of assurance that your use of this product in a residential environment will not result in harmful interference with other electronic devices.

This equipment generates/uses radio frequencies and, if not installed and used according to the instructions found in the users manual, may cause interference harmful to the operation of other electronic devices.

Compliance with FCC regulations does not guarantee that interference will not occur in all installations. If this product is found to be the source of interference, which can be determined by turning the unit “OFF” and “ON”, please try to eliminate the problem by using one of the following measures:

Relocate either this product or the device that is being affected by the interference.

Utilize power outlets that are on different branch (circuit breaker or fuse) circuits or install AC line filter/s.

In the case of radio or TV interference, relocate/reorient the antenna. If the antenna lead-in is 300 ohm ribbon lead, change the lead-in to coaxial type cable.

If these corrective measures do not produce satisfactory results, please contact the local retailer authorized to distribute this type of product. If you can not locate the appropriate retailer, please contact Yamaha Electronics Corp., U.S.A. 6660 Orangethorpe Ave, Buena Park, CA 90620.

The above statements apply ONLY to those products distributed by Yamaha Corporation of America or its subsidiaries.

We Want You Listening For A Lifetime (for US customers only)

YAMAHA and the Electronic Industries Association’s Consumer Electronics Group want you to get the most out of your equipment by playing it at a safe level. One that lets the sound come through loud and clear without annoying blaring or distortion – and, most importantly, without affecting your sensitive hearing.

Since hearing damage from loud sounds is often undetectable until it is too late, YAMAHA and the Electronic Industries Association’s Consumer Electronics Group recommend you to avoid prolonged exposure from excessive volume levels.



PROFILE OF THIS UNIT

Thank you for purchasing the Yamaha DDP-1, a sophisticated digital sound processor designed specifically for decoding Dolby AC-3.

This unit consists of an AC-3 RF demodulator, an AC-3 decoder and other original Yamaha functions developed using the newest technology to reproduce AC-3 encoded sources precisely as movie sound creators intended. AC-3 will lead listeners into a totally new sound experience.

This unit is equipped with "discrete" terminals for sending AC-3 multi-channel audio signals individually. The audio amplifier or receiver must have "discrete" input terminals to receive the signals from the DDP-1. The use of Yamaha RX-V2090, a multi-channel audio/video receiver equipped with discrete input terminals combined with this unit is an ideal choice for the purpose of experiencing AC-3 sound, and this is the best system we recommend.

What's Dolby AC-3?

Dolby AC-3 is a new generation of multi-channel digital audio technology, or the newest spatial sound processing format developed for 35 mm film-movies by employing a new kind of low bit-rate audio coding.

Dolby Surround AC-3 is a digital surround sound system that provides completely independent multi-channel audio to consumers.

In multi-channel form, Dolby Surround AC-3 provides five full range channels in what is sometimes referred to as a "3/2" configuration: three front channels (left, center and right), plus two surround channels. A sixth bass-only effect channel is also provided for output of LFE (low frequency effect), or low bass effects that are independent of other channels. This channel is counted as 0.1, thus giving rise to the term 5.1 channels in total.

Compared to Dolby Pro Logic that is referred to a "3/1" system (left front, center, right front and just one surround channel), Dolby Surround AC-3 features two surround channels, called stereo or split surrounds, each offering the same full range fidelity as the three front channels.

Sound of wide dynamic range reproduced by the five full range channels presents listeners much excitement that has never been experienced before. Precise sound orientation by the discrete digital sound processing expands realism that the original movie possesses.

Laser Disc is a home audio format that could benefit from Dolby AC-3. In the near future, Dolby AC-3 will also be applied to DBS, CATV, DVD and HDTV. The ongoing release of Dolby Stereo Digital theatrical films now underway will provide an immediate source of AC-3 encoded video software.



Manufactured under license from Dolby Laboratories Licensing Corporation. "Dolby", "AC-3", and the double-D symbol  are trademarks of Dolby Laboratories Licensing Corporation. Copyright 1992 Dolby Laboratories, Inc. All rights reserved.

Features of this unit

- **Dynamic range (sound scale) of source can be changed so that it will be suitable for the listening conditions.**
- **Output of low bass from any channel can be assigned to either the MAIN OUTPUT terminals or SUBWOOFER OUTPUT terminal to maximize system performance.**
- **Output of LFE can be assigned to either the MAIN OUTPUT terminals or SUBWOOFER OUTPUT terminal to maximize system performance.**
- **Test tone generator helps you adjust speaker level balance.**
- **Center channel output can be sent to the main speakers if you do not use a center channel speaker.**
- **Three types of inputs (AC-3 RF, AC-3 Digital Optical and Coaxial) are available for future use.**

SPEAKER SYSTEM SETUP

As described on page 4, we recommend you to use this unit connecting with the Yamaha RX-V2090. If you have already set up a speaker system for the RX-V2090, you do not need to prepare a new speaker system for this unit. Some functions on this unit have been already preset to be suitable when this unit is used with a speaker system for the RX-V2090. (Refer to page 10 for details about those functions.)

This unit will provide the best performance with a five-speaker system setup: one pair of main speakers for main sound reproduction, one pair of surround speakers for effect and surround sounds and one center speaker for dialog. A simple speaker system excluding a center speaker will still provide impressive ambience and effects, however, and may be a good way to begin with this unit. You can always upgrade to the five speaker system later.

* For the best performance of the RX-V2090, the system needs one more pair of surround speakers at the front position. (Refer to the owner's manual of the RX-V2090 for details.)

Main speakers should be high performance models and have enough power handling capacity to accept the maximum output of your system.

Surround speakers and a **center speaker** do not have to be equal to the main speakers. For precise sound localization, however, it is ideal to use high performance models that can reproduce sounds in full range. If for some reason it is not practical to use a center speaker, you can enjoy AC-3 effect without it. Best results, however, are obtained with the full system.

Speaker system configurations

Five-speaker system

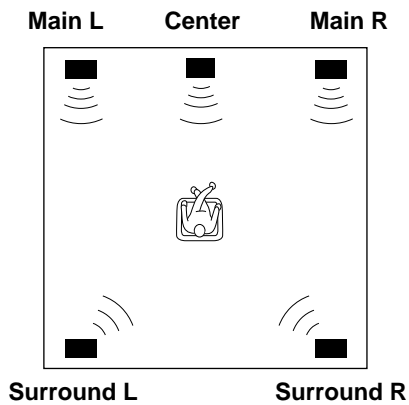

Set the center channel mode (C2. CENTER SP.) to the **SML** or **LRG** position. (See page 10.)

Note

If you will add a subwoofer in your system that includes the RX-V2090, connect the subwoofer to the "LOW PASS" terminal of the RX-V2090. In doing so, the overall adjustment of speaker output levels including the subwoofer can be done with the master VOLUME control of the RX-V2090.

A simple system without a center speaker

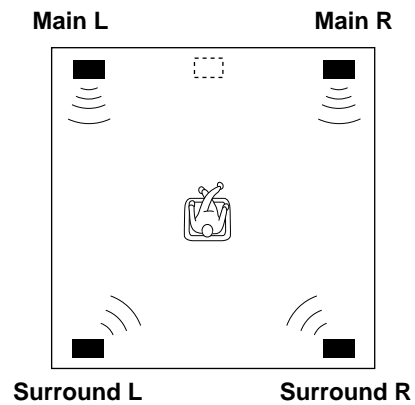

Set the center channel mode (C2. CENTER SP.) to the **PHANTOM** position. (See page 10.)

Speaker placement

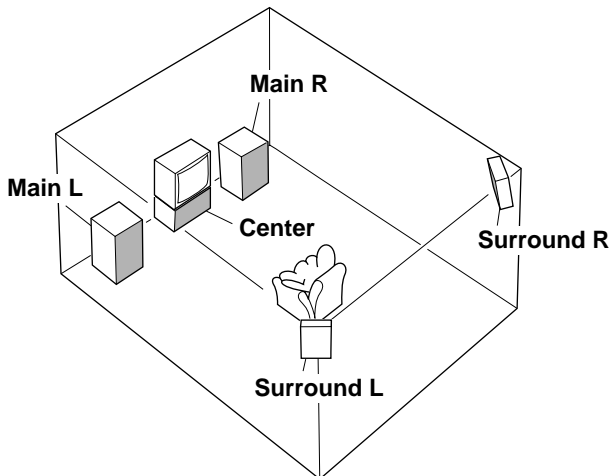

- Main:** In normal position. (The position of your present stereo speaker system.)
- Surround:** Behind your listening position, facing slightly inward. Nearly six feet (approx. 1.8 m) up from the floor.
- Center:** Precisely between the main speakers. (To avoid interference with TV sets, use a magnetically shielded speaker.)

CONNECTIONS

- Before attempting to make any connections to or from this unit, be sure to first switch OFF the power to this unit and to any other components to which connections are being made.

- When making connections between this unit and other components, be sure all connections are made correctly, L (left) to L, R (right) to R. Also, refer to the owner's manual for each component to be connected to this unit.

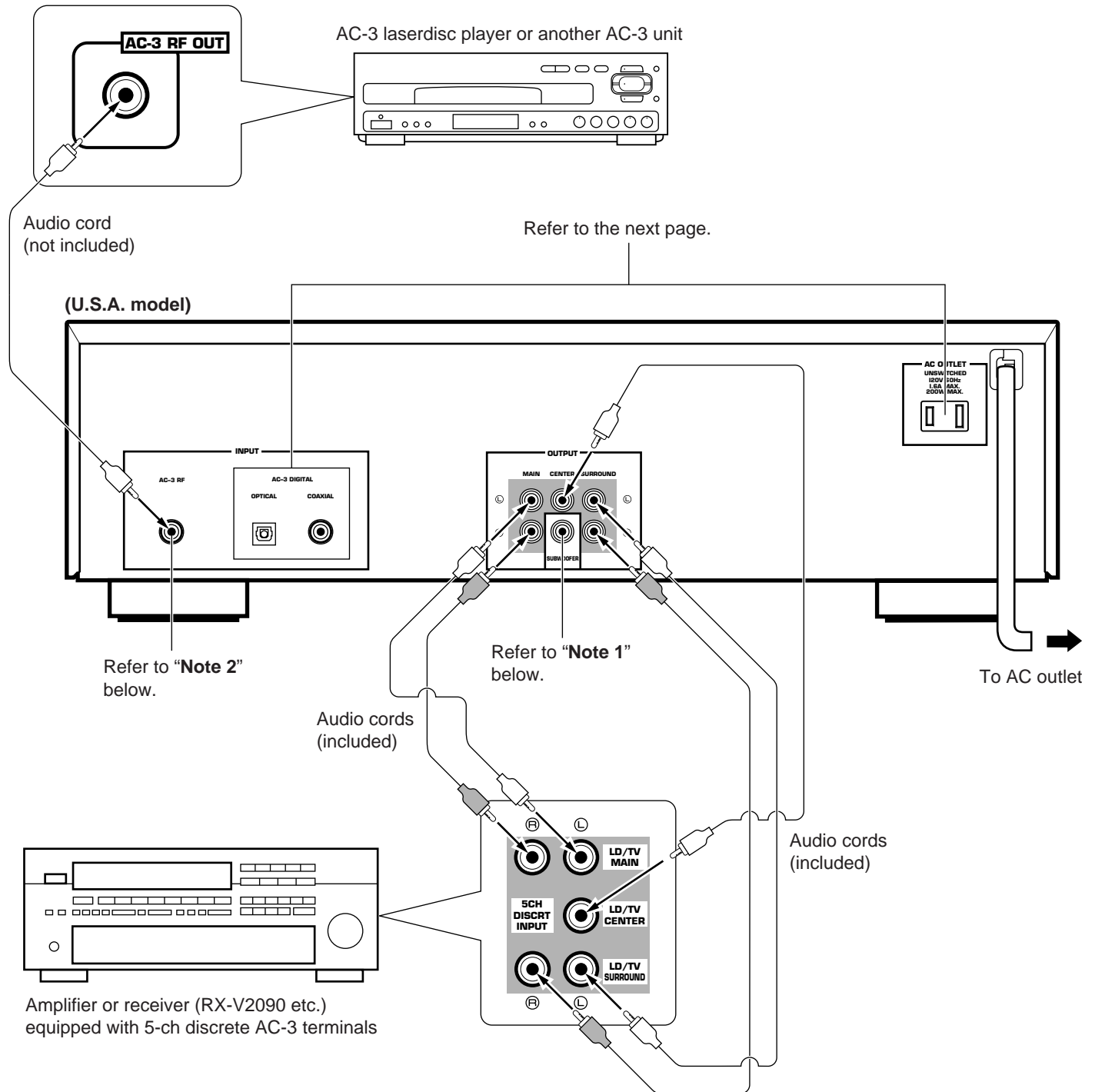

Note 1) If this unit is connected to the RX-V2090, no connection is needed to this terminal. By the output mode selections on function C2 to C5, low frequency signals including signals from the LFE channel can be output from the main L and R speakers. (See page 10 for details.)
If the amplifier has a discrete subwoofer input terminal, connect it with this unit's SUBWOOFER OUTPUT terminal.

Note 2) Do not connect a normal audio output terminal of a laserdisc player etc. to this unit's AC-3 RF terminal.

AC-3 DIGITAL OPTICAL/COAXIAL terminals

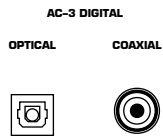

These terminals input AC-3 signals in digital signal format. They are provided for future use.

* Do not remove the cover of the OPTICAL terminal unless you will use this terminal in order to protect the terminal from dust.

AC OUTLET (UNSWITCHED)

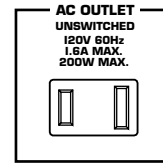

The power cord of any audio/video unit can be connected to this outlet.

The power to this outlet is not controlled by this unit's **POWER** switch. This outlet will supply power to the connected unit even if this unit is turned off.

The maximum power that can be connected to this outlet is 200 watts.

TURNING ON/OFF THE POWER OF THIS UNIT

Turn on the power of this unit when you will play an AC-3 source (an AC-3 laserdisc etc.), or if you desire to make some adjustments or mode setting changes to this unit.

To turn on the power

Press the **POWER** switch.

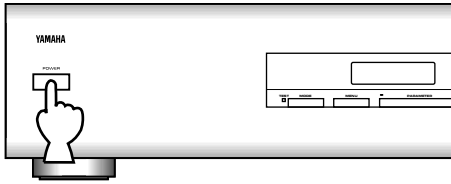

The display turns on and shows this message for about 2 seconds, and then turns into the following messages.

YAMAHA
AC-3 DECODER

When an AC-3 data is input to this unit, the characteristics of the data (from the source) are shown.

ex.)

AC-3 DECODING
fs=48k ch : 3/2

Sampling frequencies

Audio code

When there is no data input, or data other than AC-3 is input to this unit, the input terminal on the rear of this unit used for connection is shown.

ex.)

NO AC-3 DATA
INPUT RF

To turn off the power

Press the **POWER** switch so that the display turns off.

About the Audio Code

Audio code shows the formation and the number of channels.

ch : 3/2

3: Three channel outputs at the front:
left main, center and right main
2: Two channel outputs at the front:
left main and right main
1: Center channel output only at the front

2: Two channel outputs at the rear:
left surround and right surround
1: Monaural surround channel output at the rear
0: No output at the rear

TABLE OF FUNCTIONS

The following 15 functions on this unit allows you to change several adjustments and mode settings for enhancing the performance of your audio system including this unit. For adjustment or mode setting change on each menu function, refer to page 10–17.

MODE (Category)	MENU (Function)	PARAMETER (Control range/Choices)	Preset value (Position)	Step of change
A	1. CENTER DELAY	0 ms to 5 ms	0 ms	1 ms
	2. SURROUND DELAY	0 ms to 15 ms	5 ms	1 ms
	3. DYNAMIC RANGE	MAX/STANDARD	MAX	–
	4. HIGH LEVEL CUT SCALE*	0.0 to 1.0	1.0	0.2
	5. LOW LEVEL BOOST SCALE*	0.0 to 1.0	1.0	0.2
B	1. TEST: OFF/ON	LEFT/CENTER/RIGHT/ RIGHT SURROUND/ LEFT SURROUND	OFF	–
	2. LEFT SURROUND LEVEL	–6 dB to +6 dB	0 dB	1 dB
	3. RIGHT SURROUND LEVEL	–6 dB to +6 dB	0 dB	1 dB
	4. LFE MIX LEVEL	MUTE, –20 dB to 0 dB	0 dB	1 dB
	5. OUTPUT TRIM	–9 dB to 0 dB	0 dB	0.5 dB
C	1. INPUT	RF/OPTICAL/COAXIAL	RF	–
	2. CENTER SPEAKER	SMALL/LARGE/PHANTOM	SMALL	–
	3. REAR SPEAKERS	SMALL/LARGE	SMALL	–
	4. MAIN SPEAKERS	SMALL/LARGE	LARGE	–
	5. LFE/BASS OUT	MAIN/SUBWOOFER	MAIN	–

Note

* : Items A4 and A5 are adjustable only when item A3 is set to “STANDARD”.

Memory back up

Parameter changes you made the last time will remain memorized even if the power of this unit is switched off or the power cord is disconnected. However, if the power is not supplied for more than about two weeks, all parameters will be automatically changed back to the original settings.

ADJUSTMENTS BEFORE OPERATION

SELECTING THE INPUT AND OUTPUT MODES SUITABLE FOR YOUR SPEAKER SYSTEM

This unit provides you the following five functions to determine the modes of input and distribution of output signals to speakers suitable for your audio system. C4 and C5 have been already preset in the position suitable for using this unit with the RX-V2090.

- C1. INPUT**
- C2. CENTER SPEAKER**
- C3. REAR SPEAKERS**
- C4. MAIN SPEAKERS**
- C5. LFE/BASS OUT**

Description of each function

C1. INPUT

Choices: RF/OPT./COAX.
Preset position: RF

Selects the name of the input terminal on the rear of this unit used for the connection with an AC-3 laserdisc player or another AC-3 unit.

C2. CENTER SPEAKER

Choices: SML/LRG/PHANTOM
Preset position: SML

SML: Select this position when you use a center speaker that is smaller than the main speakers. In this position, low bass signals (below 90 Hz) at the center channel are output from the MAIN OUTPUT terminals.

LRG: Select this position when your center speaker is approximately the same size as the main speakers.

PHANTOM:
Select this position when you do not have a center speaker. The center channel sound will be output from the left and right main speakers.

C3. REAR SPEAKERS

Choices: SMALL/LARGE
Preset position: SMALL

SMALL: Select this position if your rear surround speakers do not have a high ability for bass reproduction. In this position, low bass signals (below 90 Hz) at the surround channels are output from the MAIN OUTPUT terminals.

LARGE: Select this position if your rear surround speakers have a high ability for bass reproduction, or a subwoofer is connected to the surround speaker in parallel. In this position, full range signals are output from the SURROUND OUTPUT terminals.

C4. MAIN SPEAKERS

Choices: SMALL/LARGE
Preset position: LARGE

SMALL: Select this position if your main speakers do not have a high ability for bass reproduction. However, if your system does not include a subwoofer, do not select this position.

In this position, low bass signals (below 90 Hz) at the main channels are output from the SUBWOOFER OUTPUT terminals (if the SUBWOOFER position is selected on "C5. LFE/BASS OUT").

LARGE: **Be sure to select this position, if this unit is connected to an amplifier or receiver (RX-V2090 etc.) equipped with 5-ch discrete AC-3 input terminals.**

In this position, full range signals present at the main channels are output from the MAIN OUTPUT terminals.

Select this position if your main speakers have a high ability for bass reproduction.

C5. LFE/BASS OUT

Choices: MAIN/SUBWOOFER
Preset position: MAIN

MAIN: **Be sure to select this position, if this unit is connected to an amplifier or receiver (RX-V2090 etc.) equipped with 5-ch discrete AC-3 input terminals.**

In this position, full range signals present at the main channels, signals from the LFE channel and other low bass signals that are selected on C2 to C4 to be distributed from other channels are output from the MAIN OUTPUT terminals.

SUBWOOFER:

Select this position if this unit is connected to an amplifier or receiver equipped with a subwoofer (or LFE) input terminal.

In this position, signals at LFE channel and other low bass signals that are selected on C2 to C4 to be distributed from other channels are output from the SUBWOOFER OUTPUT terminals.

Method of changing selections

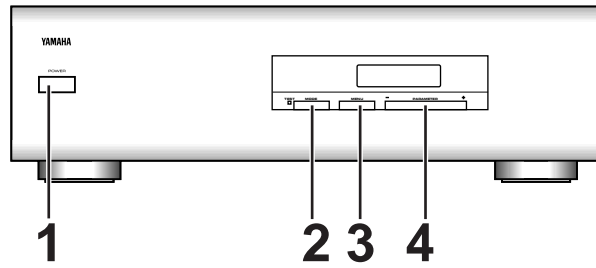

1 Turn the power on.

POWER

2

MODE

Press once or more until "C" appears on the left side of the display.

3

MENU

Press once or more until the title of function on which you will change the selection appears on the display.

4

PARAMETER

Press "+" side or "-" side once or more so that the arrow points the position you will select.

5 Repeat step 3 and 4 to change selections on other functions in the same way.

Note
If there is no operation for about 5 seconds, the original message will be restored on the display.

OUTPUT BALANCE ADJUSTMENT

Adjusting the output level balance among all the channels are very important to maximize the performance of your system including this unit. This unit lets you adjust the sound output level balance between the left and right surround channels using the built-in test tone generator. Before making the adjustment on this unit, you should make the output balance adjustment for Dolby Pro Logic on the amplifier (or receiver) connected with this unit. Follow the instructions below.

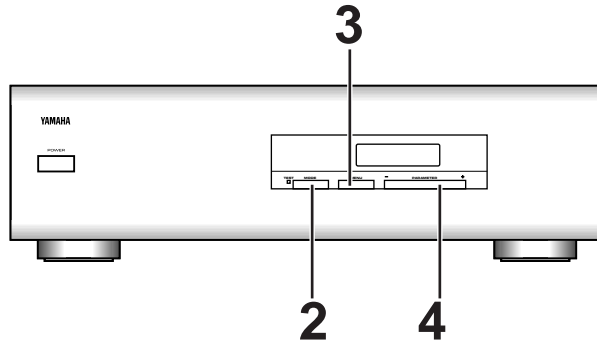

BEFORE MAKING THE ADJUSTMENT ON THIS UNIT
 Be sure to adjust the output level balance among the left main, center, right main and surround channels for Dolby Pro Logic on the amplifier (or receiver) connected to this unit using a test tone generator built into the amplifier. Adjust the balance so that the levels of those channels become almost the same when you hear the test tone at the listening position. If you have finished adjusting the output balance on the amplifier, then go on to the adjustment on this unit by following the procedure below.
 * For output balance adjustment for Dolby Pro Logic on the RX-V2090, refer to the instructions on the section "ADJUSTMENT BEFORE OPERATION" of the RX-V2090's manual.

1 Turn down the volume to a minimum level on the amplifier or receiver.

2 Press once or more until "B" appears on the left side of the display.

3 Press once or more until the following message appears on the display.

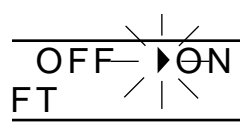
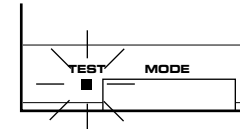
4 Press "+" side once so that the arrow points "ON".



5 Turn up the volume on the amplifier.
 You will hear a test tone (like pink noise) from the left main speaker, then the center speaker, then the right main speaker, then the right surround speaker and then the left surround speaker, for about two seconds each. The display changes as shown below.

```

    LEFT ←
    ↓
    CENTER
    ↓
    RIGHT
    ↓
    RIGHT SURROUND
    ↓
    LEFT SURROUND
    
```

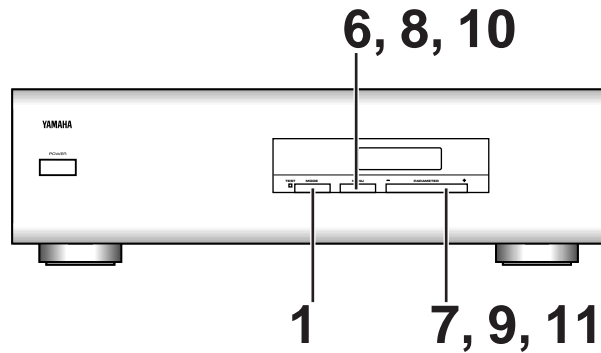
Continued



6

MENU

Press once or more until the following message appears on the display.

B2. LEFT SUR. LVL
.....0 dB

9

PARAMETER

Adjust the sound level of the test tone from the right surround speaker to be at the same level as other speakers.
* Pressing "+" increases and "-" decreases the value.
Pressing and holding the button will change the value continuously.

LVL
..0 dB

Changes.

7

PARAMETER

Adjust the sound level of the test tone from the left surround speaker to be at the same level as the main and center speakers.
* Pressing "+" increases and "-" decreases the value.
Pressing and holding the button will change the value continuously.

LVL
..0 dB

Changes.

10

MENU

When the adjustments are finished;
Press once or more until the following message appears on the display.

B1. TEST : OFF ▶ ON
LEFT

8

MENU

Press once or more until the following message appears on the display.

B3. RIGHT SUR. LVL
.....0 dB

11

PARAMETER

MODE

Press "-" side once so that the arrow points "OFF".

or

TEST MODE

The test tone will stop.

Goes off.

PLAYING AN AC-3 SOURCE

1 Turn down the volume to minimum on the amplifier.

2 Turn the power on to the AC-3 unit, this unit, the amplifier, the monitor etc.

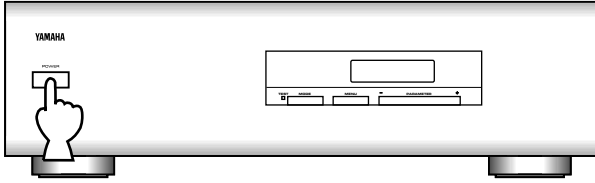

3 If necessary, change the input mode setting on the amplifier to the "5-ch discrete AC-3 input".
* For the **RX-V2090**, press the LD/TV button on the front panel of the RX-V2090 so that "5 CH DISCRT" appears on the display. (Refer to the section "Dolby Surround AC-3" of the RX-V2090's manual.)

4 Play an AC-3 source on the AC-3 unit.

5 Turn up the volume on the amplifier.

6 If desired, adjust output levels, delays, dynamic range, etc. on this unit. (See page 14–17 for details.)

ADJUSTING OUTPUT LEVELS

The following output level adjustments are possible on this unit. Adjust them as you prefer, monitoring source sound.

- B2. LEFT SURROUND LEVEL**
- B3. RIGHT SURROUND LEVEL**
- B4. LFE MIX LEVEL**
- B5. OUTPUT TRIM**

Description of each function

B2. LEFT SURROUND LEVEL

Control range: –6 dB to +6 dB (in 1 dB step)
Preset value: 0 dB

Adjusts the output level at the left surround channel. You had already adjusted the level in "OUTPUT BALANCE ADJUSTMENT" on page 13, however you can change the level if you wish.

B3. RIGHT SURROUND LEVEL

Control range: –6 dB to +6 dB (in 1 dB step)
Preset value: 0 dB

Adjusts the output level at the right surround channel. You had already adjusted the level in "OUTPUT BALANCE ADJUSTMENT" on page 13, however you can change the level if you wish.

B4. LFE MIX LEVEL

Control range: MUTE, –20 dB to 0 dB (in 1 dB step)
Preset value: 0 dB

Adjusts the output level at the LFE (low frequency effect) channel. If the LFE signals are mixed with signals at the main channels, only the level of the LFE signals are adjusted. When adjusted to MUTE, only the LFE sound will not be output.

B5. OUTPUT TRIM

Control range: –9 dB to 0 dB (in 0.5 dB step)
Preset value: 0 dB

Adjusts the output level at all channels.

Method of adjusting levels

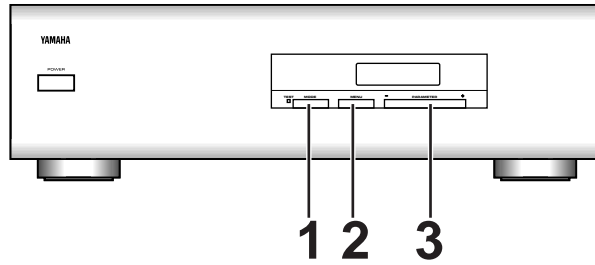

1

MODE

Press once or more until "B" appears on the left side of the display.

↓

B1. TEST :

2

MENU

Press once or more until the title of function whose level you will change appears on the display.

↓

B2. LEFT SUR. LVL
.....0 dB

3 Adjust the level.

PARAMETER

Pressing "+" increases and "-" decreases the value. Pressing and holding the button will change the value continuously.

↓

LVL
...0 dB

Changes.

4 Repeat step 2 and 3 to adjust levels on other functions in the same way.

Note

If there is no operation for about 5 seconds, the original message will be restored on the display.

ADJUSTING DELAYS AND DYNAMIC RANGE

This unit provides you with the following functions to make the AC-3 sound field suitable for the conditions of your listening room.

- A1. CENTER DELAY**
- A2. SURROUND DELAY**
- A3. DYNAMIC RANGE**
- A4. HIGH LEVEL CUT SCALE**
- A5. LOW LEVEL BOOST SCALE**

Description of each function

A1. CENTER DELAY

Control range: 0 ms to 5 ms (in 1 ms step)
Preset value: 0 ms

Adjusts the delay between the main sounds (at the main channels) and dialog etc. (at the center channel). The larger the value, the later the dialog is generated.

A2. SURROUND DELAY

Control range: 0 ms to 15 ms (in 1 ms step)
Preset value: 5 ms

Adjusts the delay between the main sounds (at the main channels) and the effect sounds (at the surround channels). The larger the value, the later the effect sounds are generated.

A3. DYNAMIC RANGE

Choices: MAX/STANDARD
Preset position: MAX

MAX: "Dynamic range" is the difference between the maximum level and the minimum level of sounds. Sounds on a movie originally designed for movie theaters feature very wide dynamic range. AC-3 technology can bring the original sound track into a home audio format with this wide dynamic range unchanged. In this position, an AC-3 source is reproduced in the original sound track's wide dynamic range providing you with powerful sounds like a movie theater. Selecting this position will be more ideal if you can listen to a source in a high output level in a room specially soundproofed for audio/video enjoyment.

STANDARD:

Powerful sounds of extremely wide dynamic range are not always suitable for home use. Depending upon the condition of your listening environment, it may not be possible to increase the sound output level as high as a movie theater, however, in a level proper for listening to in your room, the low level parts of source sound cannot be heard as well because they will be lost among noises in your environment.

AC-3 technology also makes it possible to reduce an original sound track's dynamic range for a home audio format by "compressing" the data.

In this position, an AC-3 source is reproduced in the "compressed" dynamic range of the source suitable for low level listening.

If you desire, you can also adjust the dynamic range on function A4 and A5 only when this position is selected. (See the right side for details.)

A4. HIGH LEVEL CUT SCALE

Control range: 0.0 to 1.0 (in 0.2 step)
Preset value: 1.0

Adjusts the dynamic range of high level signals of source. The larger the value, the range is more reduced. The smaller the value, the range is more widened.

Note: This function is available only when the "STANDARD" position is selected on the function A3.

A5. LOW LEVEL BOOST SCALE

Control range: 0.0 to 1.0 (in 0.2 step)
Preset value: 1.0

Adjusts the dynamic range of low level signals of source. The larger the value, the range is more widened. The smaller the value, the range is more reduced.

Note: This function is available only when the "STANDARD" position is selected on the function A3.

Method of changing the level (or the selection)

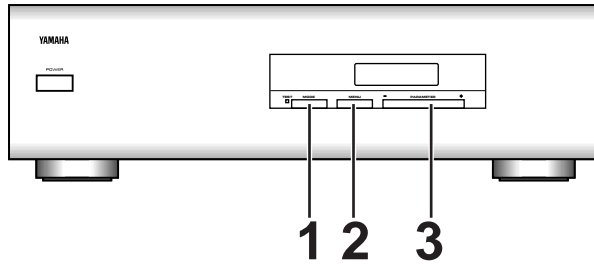

1

MODE

Press once or more until "A" appears on the left side of the display.

2

MENU

Press once or more until the title of function whose level (or selection) you will change appears on the display.

3 Change the level (or the selection).

* For changing the value, pressing "+" increases and "-" decreases the value. Pressing and holding the button will change the value continuously.

4 Repeat step 2 and 3 to make changes on other functions in the same way.

Note
If there is no operation for about 5 seconds, the original message will be restored on the display.

SPECIFICATIONS

Output Level/Output Impedance
 MAIN L/R, CENTER, SURROUND L/R
 1 kHz, 0 dB INPUT2V/1.2 kΩ
 SUBWOOFER
 50 Hz, 0 dB INPUT6V/1.2 kΩ

Input Impedance (RF, COAXIAL).....75Ω

Frequency Response
 MAIN L/R, CENTER, SURROUND L/R (LARGE)
 20 Hz–20 kHz.....0 ± 1 dB

Filter Characteristics
 MAIN L/R, CENTER, SURROUND L/R (SMALL)
 H.P.F.fc=90 Hz, 12 dB/oct.
 SUBWOOFER
 L.P.F.fc=90 Hz, 24 dB/oct.

Total Harmonic Distortion
 MAIN L/R, CENTER, SURROUND L/R (1 kHz)
0.01% or less
 SUBWOOFER (50 Hz)0.01% or less

Signal to Noise Ratio (IHF-A)105 dB or more

Channel Separation (1 kHz)80 dB or more

Power Supply
 U.S.A. model.....AC 120V, 60 Hz
 General modelAC 110/120/220/240V, 50/60 Hz

Power Consumption35W

AC OUTLET
 UNSWITCHED x 1200W max.

Dimensions (W x H x D)435 mm x 126 mm x 351.7 mm
 (17-1/8" x 4-15/16" x 13-7/8")

Weight6.1 kg (13 lbs. 7 oz.)

* Please note that all specifications are subject to change without notice.

TROUBLESHOOTING

If the unit fails to operate normally, check the following points to determine whether the fault can be corrected by the simple measures suggested. If it cannot be corrected, or if the fault is not listed in the SYMPTOM column, disconnect the power cord and contact your authorized YAMAHA dealer or service center for help.

SYMPTOM	CAUSE	REMEDY
The unit fails to turn on when the POWER switch is pressed.	Power cord is not plugged in or is not completely inserted.	Firmly plug in the power cord.
No sound.	Incorrect input or output cord connections.	Connect the cords properly. If the problem persists, the cords may be defective.
	Improper input mode selection.	Select the proper input mode (RF, OPT or COAX).
	Improper input mode selection on the amplifier.	Select the "5-ch discrete AC-3 input" mode on the amplifier.
Sound "hums".	Incorrect cord connections.	Firmly connect the audio plugs. If the problem persists, the cords may be defective.
Poor bass reproduction.	The setting of LFE/BASS OUT is at the SUBWOOFER position, though your system does not include a subwoofer.	Select the MAIN position.
	Output mode selection for each channel (MAIN, CENTER or REAR) is improper.	Make output mode selections suitable for your speaker system.
Sound output level to either or both of the rear surround speakers is lower than other speakers.	Sound output level to either or both of the rear surround speakers is decreased.	Increase the level.
No sound from the center speaker.	The setting of CENTER SP. is at the PHANTOM position.	Select the SML or LRG position.
No output of LFE sound.	The output level of LFE (LFE MIX LVL) is adjusted to MUTE.	Increase the level.
Whole sound level is low, even though the volume is increased on the amplifier.	Output level (OUTPUT TRIM) adjustment on this unit is low.	Increase the level.
The difference of sound level between a high level part and a low level part is too great.	The setting of the DYNAMIC RANGE is at the MAX position.	Select the STANDARD position.
Noise from nearby TV or tuner.	This unit is too close to the affected equipment.	Move this unit further away from the affected equipment.



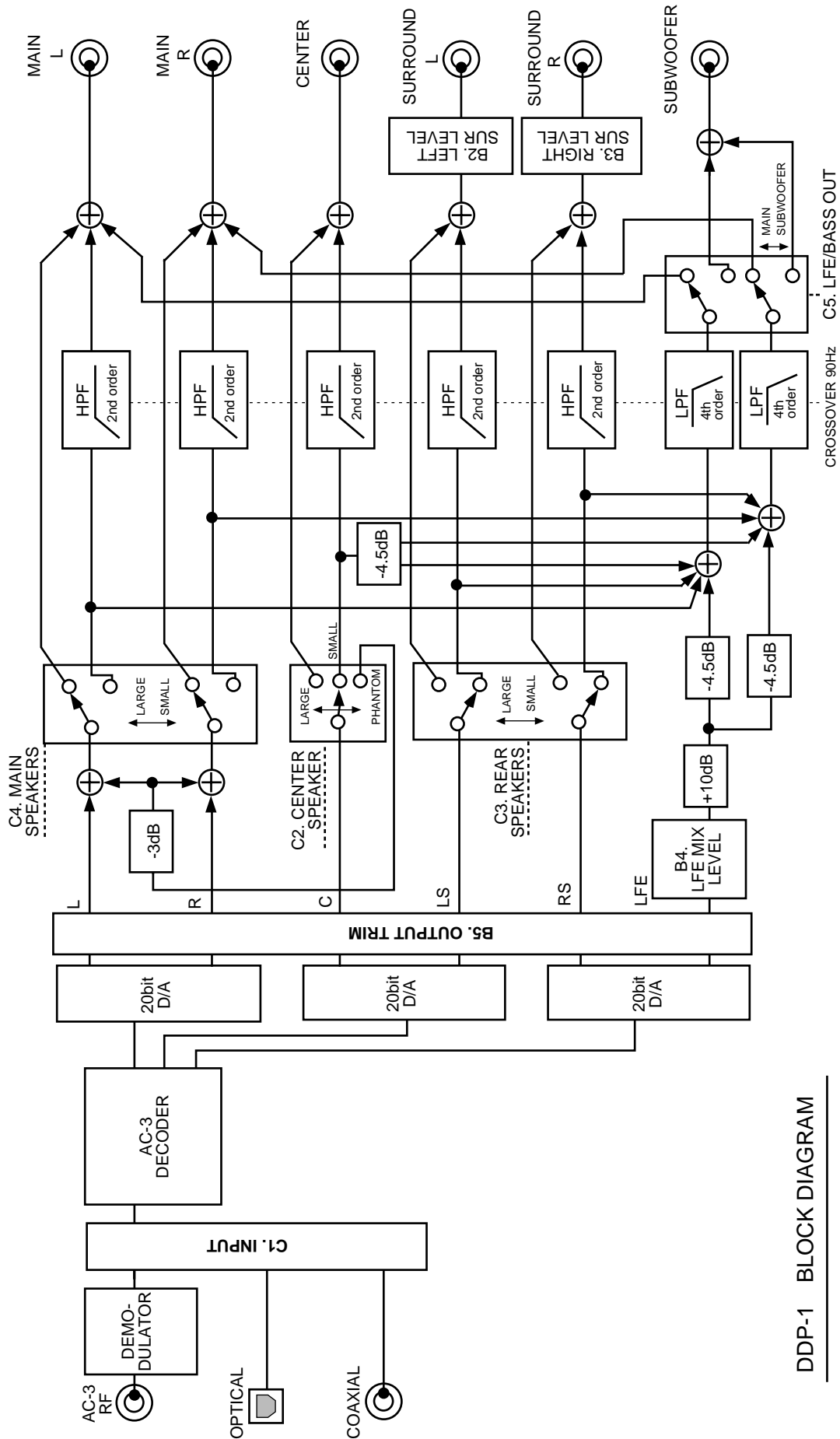







BLOCK DIAGRAM

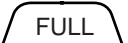

DDP-1 BLOCK DIAGRAM

FOR REFERENCE

The following table shows what terminal(s) the signals of each channel are output to according to the output mode settings on C2 to C5. (See page 10 for details.)

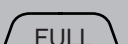
		MAIN OUTPUT	CENTER OUTPUT	SURROUND OUTPUT	SUBWOOFER OUTPUT
C2. CENTER	SMALL	90 Hz or less  *1	 90 Hz or more		90 Hz or less  *2
	LARGE				
C3. REAR	SMALL	90 Hz or less  *1		 90 Hz or more	90 Hz or less  *2
	LARGE				
C4. MAIN	SMALL	 *1			
		 90 Hz or more *2			90 Hz or less  *2
	LARGE				
C5. LFE /BASS OUT	MAIN	LFE 90 Hz or less (from MAIN*3, CENTER*3 and REAR*4)			
	SUBWOOFER				LFE 90 Hz or less (from MAIN*5, CENTER*3 and REAR*4)

- *1 : When **C5. LFE/BASS OUT** is set at the **MAIN** position
- *2 : When **C5. LFE/BASS OUT** is set at the **SUBWOOFER** position
- *3 : When **C2. CENTER** is set at the **SMALL** position
- *4 : When **C3. REAR** is set at the **SMALL** position
- *5 : When **C4. MAIN** is set at the **SMALL** position

 : The shaded areas show the original settings and output modes.