

GX-707

MINI COMPONENT SYSTEM CHAÎNE COMPACTE

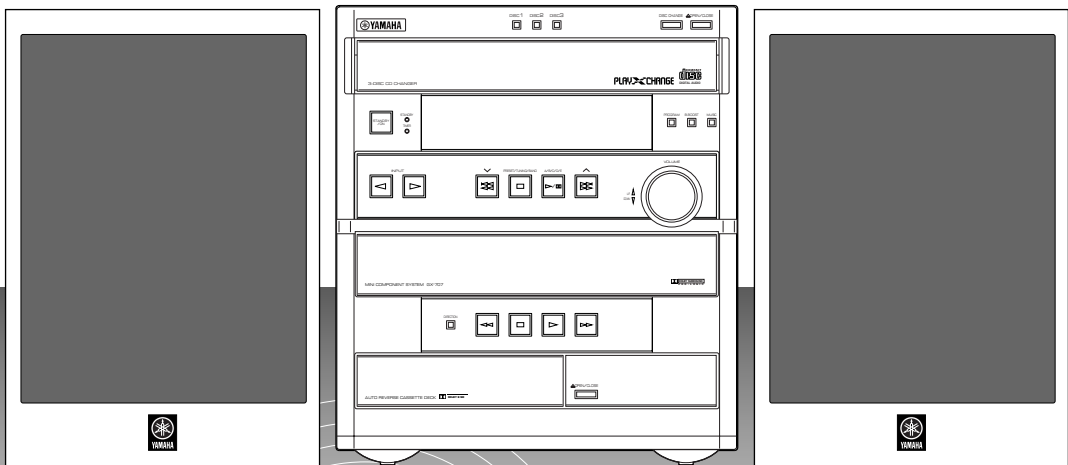

**OWNER'S MANUAL
MODE D'EMPLOI**

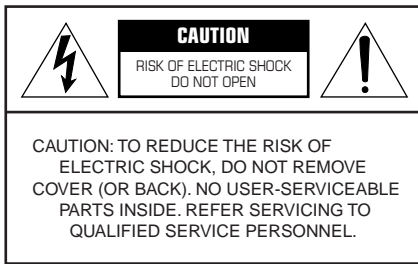

IMPORTANT
 Please record the serial number of this system in the space below.
 Model:
 Serial No.:
 The serial number is located on the rear of the main unit.
 Retain this Owner's Manual in a safe place for future reference.

Explanation of Graphical Symbols



The lightning flash with arrowhead symbol, within an equilateral triangle, is intended to alert you to the presence of uninsulated "dangerous voltage" within the product's enclosure that may be of sufficient magnitude to constitute a risk of electric shock to persons.



The exclamation point within an equilateral triangle is intended to alert you to the presence of important operating and maintenance (servicing) instructions in the literature accompanying the appliance.

WARNING
 TO REDUCE THE RISK OF FIRE OR ELECTRIC SHOCK, DO NOT EXPOSE THIS APPLIANCE TO RAIN OR MOISTURE.

SAFETY INSTRUCTIONS

- 1 Read Instructions – All the safety and operating instructions should be read before the unit is operated.
- 2 Retain Instructions – The safety and operating instructions should be retained for future reference.
- 3 Heed Warnings – All warnings on the unit and in the operating instructions should be adhered to.
- 4 Follow Instructions – All operating and other instructions should be followed.
- 5 Water and Moisture – The unit should not be used near water – for example, near a bathtub, washbowl, kitchen sink, laundry tub, in a wet basement, or near a swimming pool, etc.
- 6 Carts and Stands – The unit should be used only with a cart or stand that is recommended by the manufacturer.
- 6A A unit and cart combination should be moved with care. Quick stops, excessive force, and uneven surfaces may cause the unit and cart combination to overturn. 
- 7 Wall or Ceiling Mounting – The unit should be mounted to a wall or ceiling only as recommended by the manufacturer.
- 8 Ventilation – The unit should be situated so that its location or position does not interfere with its proper ventilation. For example, the unit should not be situated on a bed, sofa, rug, or similar surface, that may block the ventilation openings; or placed in a built-in installation, such as a bookcase or cabinet that may impede the flow of air through the ventilation openings.
- 9 Heat – The unit should be situated away from heat sources such as radiators, stoves, or other appliances that produce heat.
- 10 Power Sources – The unit should be connected to a power supply only of the type described in the operating instructions or as marked on the unit.
- 11 Power-Cord Protection – Power-supply cords should be routed so that they are not likely to be walked on or pinched by items placed upon or against them, paying particular attention to cords at plugs, convenience receptacles, and the point where they exit from the unit.
- 12 Cleaning – The unit should be cleaned only as recommended by the manufacturer.
- 13 Nonuse Periods – The power cord of the unit should be unplugged from the outlet when left unused for a long period of time.
- 14 Object and Liquid Entry – Care should be taken so that objects do not fall into and liquids are not spilled into the inside of the unit.
- 15 Damage Requiring Service – The unit should be serviced by qualified service personnel when:
 - A. The power-supply cord or the plug has been damaged; or
 - B. Objects have fallen, or liquid has been spilled into the unit; or
 - C. The unit has been exposed to rain; or
 - D. The unit does not appear to operate normally or exhibits a marked change in performance; or
 - E. The unit has been dropped, or the cabinet damaged.
- 16 Servicing – The user should not attempt to service the unit beyond those means described in the operating instructions. All other servicing should be referred to qualified service personnel.
- 17 Power Lines – An outdoor antenna should be located away from power lines.
- 18 Grounding or Polarization – Precautions should be taken so that the grounding or polarization is not defeated.

19 For US customers only:

Outdoor Antenna Grounding – If an outside antenna is connected to this unit, be sure the antenna system is grounded so as to provide some protection against voltage surges and built-up static charges. Article 810 of the National Electrical Code, ANSI/NFPA 70, provides information with regard to proper grounding of the mast and supporting structure, grounding of the lead-in wire to an antenna discharge unit, size of grounding conductors, location of antenna discharge unit, connection to grounding electrodes, and requirements for the grounding electrode.

Note to CATV system installer:

This reminder is provided to call the CATV system installer's attention to Article 820-40 of the NEC that provides guidelines for proper grounding and, in particular, specifies that the cable ground shall be connected to the grounding system of the building, as close to the point of cable entry as practical.

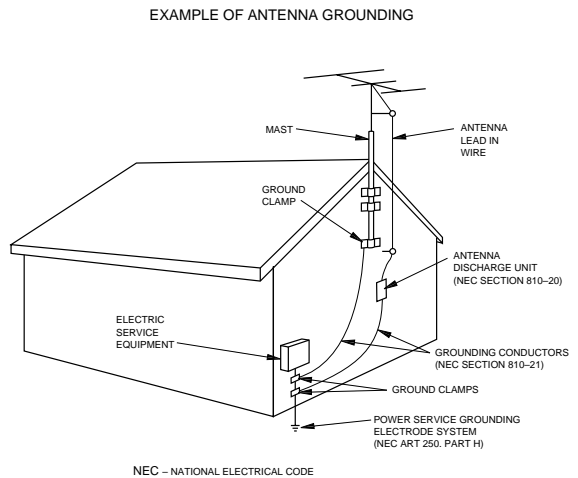

FCC INFORMATION (for US customers only)

1. IMPORTANT NOTICE : DO NOT MODIFY THIS UNIT!

This product, when installed as indicated in the instructions contained in this manual, meets FCC requirements. Modifications not expressly approved by Yamaha may void your authority, granted by the FCC, to use the product.

2. IMPORTANT : When connecting this product to accessories and/or another product use only high quality shielded cables. Cable/s supplied with this product MUST be used. Follow all installation instructions. Failure to follow instructions could void your FCC authorization to use this product in the USA.

3. NOTE : This product has been tested and found to comply with the requirements listed in FCC Regulations, Part 15 for Class "B" digital devices. Compliance with these requirements provides a reasonable level of assurance that your use of this product in a residential environment will not result in harmful interference with other electronic devices.

This equipment generates/uses radio frequencies and, if not installed and used according to the instructions found in the users manual, may cause interference harmful to the operation of other electronic devices.

Compliance with FCC regulations does not guarantee that interference will not occur in all installations. If this product is found to be the source of interference, which can be determined by turning the unit "OFF" and "ON", please try to eliminate the problem by using one of the following measures:

Relocate either this product or the device that is being affected by the interference.

Utilize power outlets that are on different branch (circuit breaker or fuse) circuits or install AC line filter/s.

In the case of radio or TV interference, relocate/reorient the antenna. If the antenna lead-in is 300 ohm ribbon lead, change the lead-in to coaxial type cable.

If these corrective measures do not produce satisfactory results, please contact the local retailer authorized to distribute this type of product. If you can not locate the appropriate retailer, please contact Yamaha Electronics Corp., U.S.A. 6660 Orangethorpe Ave, Buena Park, CA 90620.

The above statements apply ONLY to those products distributed by Yamaha Corporation of America or its subsidiaries.

We Want You Listening For A Lifetime





YAMAHA and the Electronic Industries Association's Consumer Electronics Group want you to get the most out of your equipment by playing it at a safe level. One that lets the sound come through loud and clear without annoying blaring or distortion – and, most importantly, without affecting your sensitive hearing.

Since hearing damage from loud sounds is often undetectable until it is too late, YAMAHA and the Electronic Industries Association's Consumer Electronics Group recommend you to avoid prolonged exposure from excessive volume levels.

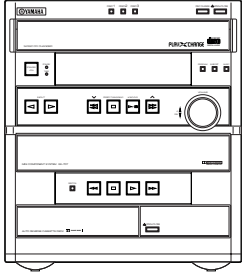
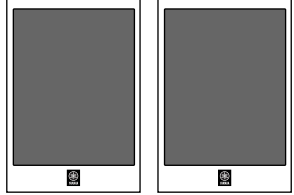

Unpacking
Déballage

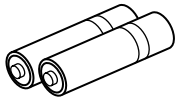
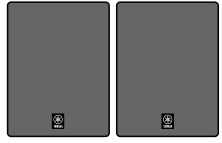
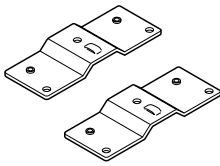
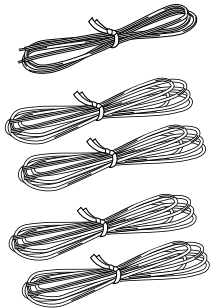
- After unpacking, check that the following parts are contained.
- Après le déballage, vérifier que les pièces suivantes sont incluses.

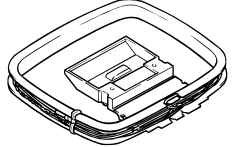
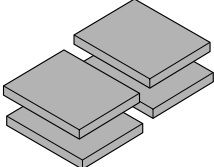
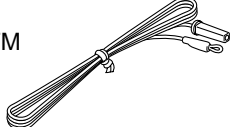
<ul style="list-style-type: none">● Main unit● Appareil principal		<ul style="list-style-type: none">● Front speakers● Enceintes avant	
<ul style="list-style-type: none">● Remote control● Télécommande		<ul style="list-style-type: none">● Center speaker● Enceinte centrale	
<ul style="list-style-type: none">● Batteries (size AA, UM/SUM-3, R6, HP-7)● Piles (format AA, UM/SUM-3, R6, HP-7)		<ul style="list-style-type: none">● Rear speakers● Enceintes arrière	
<ul style="list-style-type: none">● Mounting brackets● Supports de montage		<ul style="list-style-type: none">● Speaker cords● Câbles d'enceintes	
<ul style="list-style-type: none">● Screws● Vis		<ul style="list-style-type: none">● AM loop antenna● Antenne-cadre AM	
<ul style="list-style-type: none">● Velcro strips● Bandes Velcro		<ul style="list-style-type: none">● Indoor FM antenna● Antenne intérieure FM	

Setting this system Installation de ce système

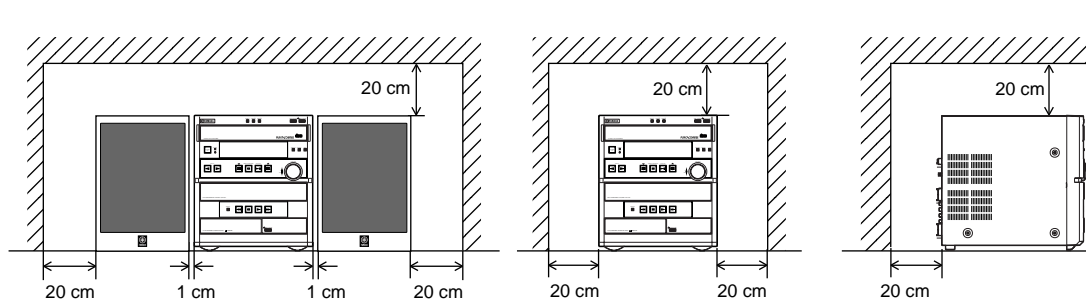

English

Set this system by allowing enough spaces around and behind the main unit to assure good ventilation. Be sure not to place another unit or any object on top of the main unit to prevent the ventilation holes from being obstructed. Otherwise, it may cause fire or damage to the main unit.

Caution

When placing the speakers apart from the main unit, be sure to allow spaces of at least **20 cm** (3-15/16") above, behind and on both sides of the main unit. If the main unit is put inside a rack, the front of it must be fully opened.

Français

Installer ce système en laissant assez d'espace autour et derrière l'appareil principal pour assurer une bonne ventilation. Veiller à ne pas empiler un autre appareil ou un autre objet sur l'appareil principal afin de ne pas boucher les orifices de ventilation. Sinon, on risquerait de provoquer un incendie ou d'endommager l'appareil principal.

Attention

Lorsqu'on place les enceintes à une certaine distance de l'appareil principal, veiller à laisser un espace d'au moins 20 cm au-dessus, derrière et sur les deux côtés de l'appareil principal. Si l'on place l'appareil principal dans un meuble, veiller à ce que le côté avant du meuble soit grand ouvert.

Front panel Panneau avant

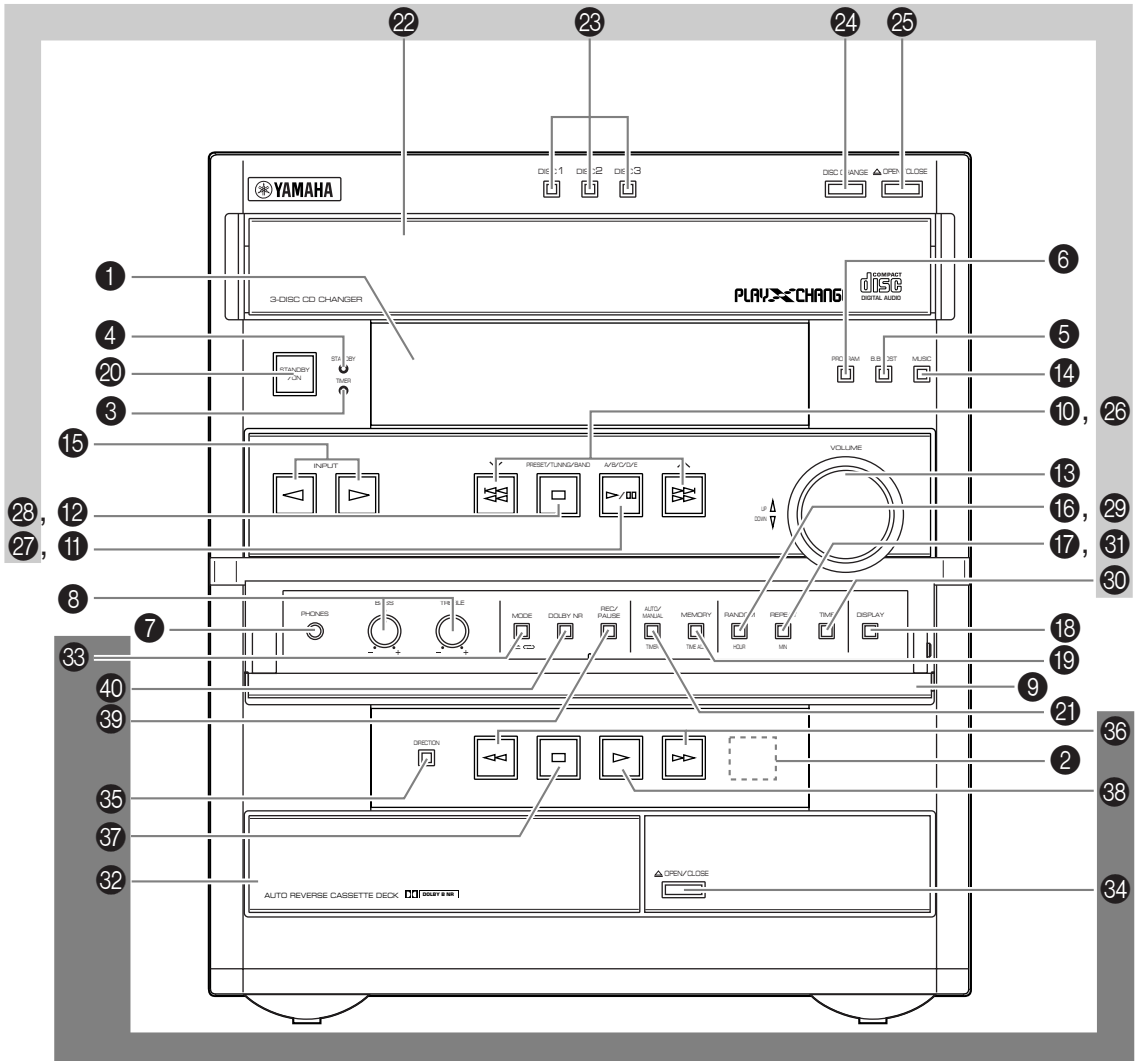

Remote control Telecommande

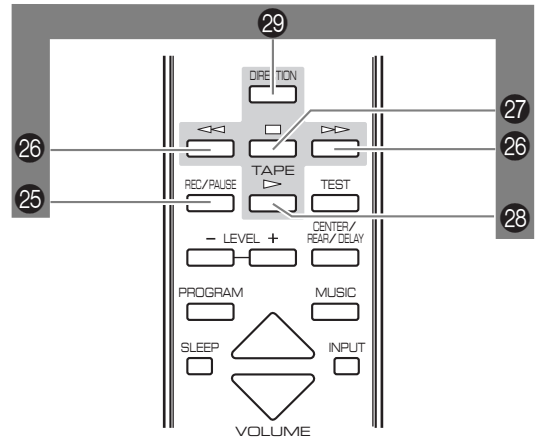
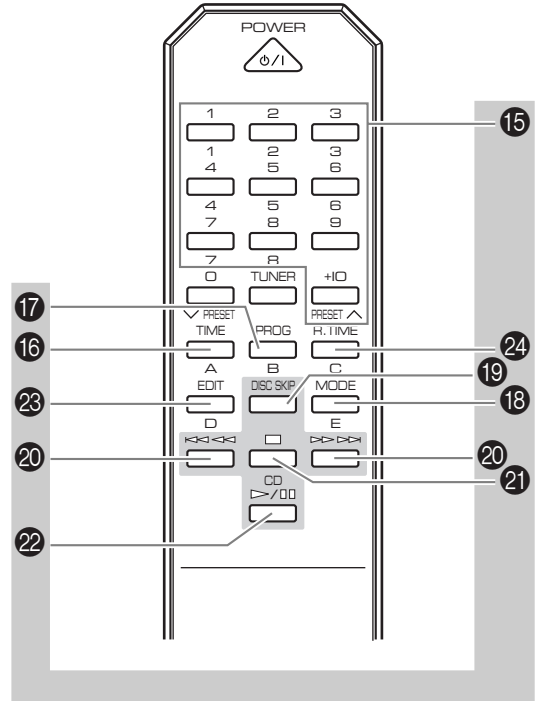
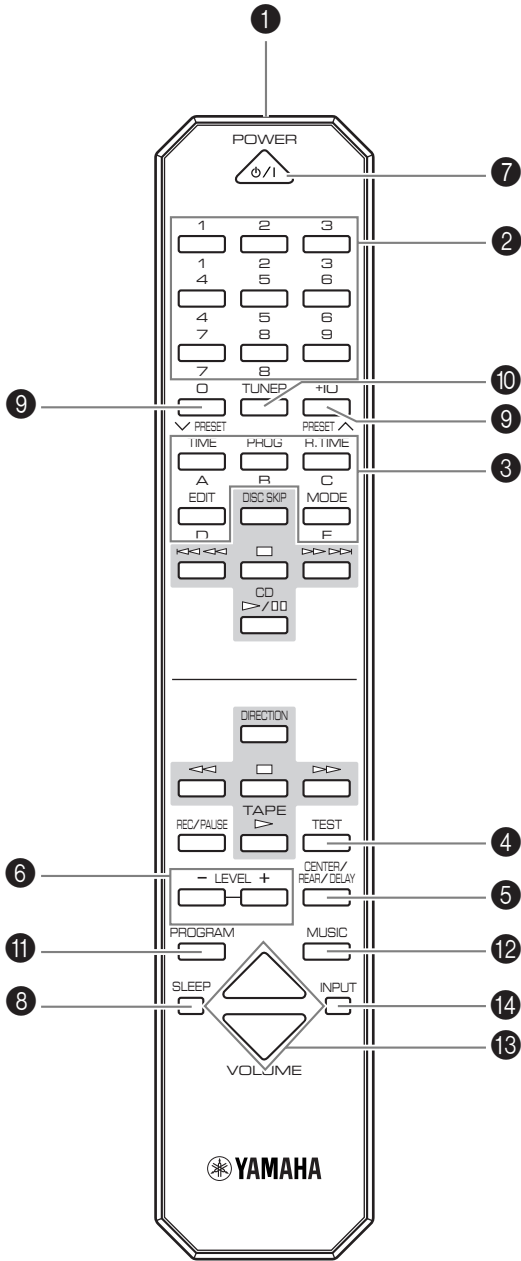

Amplifier/tuner Amplificateur/tuner

- | | |
|--|--|
| ① Transmission window
Fenêtre de transmission
[p. 5] | ⑦ POWER [p. 13] |
| ② Numeric buttons
Touches numériques
[p. 22] | ⑧ SLEEP [p. 38] |
| ③ A, B, C, D, E [p. 22] | ⑨ PRESET (^ / v) [p. 20, 22] |
| ④ TEST [p. 11] | ⑩ TUNER [p. 20] |
| ⑤ CENTER/REAR/DELAY [p. 36] | ⑪ PROGRAM [p. 35] |
| ⑥ LEVEL (-/+) [p. 36] | ⑫ MUSIC [p. 33] |
| | ⑬ VOLUME [p. 32] |
| | ⑭ INPUT [p. 13, 20, 24, 26]
TUNER → TAPE → CD
↑ ↓
AUX/MD ← VCR ← VIDEO |

CD player Lecteur de disque compact

- | | | |
|--|--------------------------|---------------------------|
| ⑮ Numeric buttons
Touches numériques
[p. 14] | ⑰ MODE [p. 14] | ⑲ □ [p. 13] |
| ⑯ TIME [p. 16] | ⑱ DISC SKIP [p. 14] | ⑳ ▷ / ⏏ [p. 13] |
| ⑰ PROG [p. 16] | ㉑ ⏮ (⏮)/⏭ (⏭)
[p. 15] | ㉒ EDIT [p. 28, 29, 30] |
| | | ㉓ R. TIME [p. 28, 29, 30] |

Tape deck Platine cassette

- | | | |
|---------------------|-------------|---------------------|
| ㉔ REC/PAUSE [p. 26] | ㉖ □ [p. 24] | ㉘ DIRECTION [p. 24] |
| ㉕ ⏮ / ⏭ [p. 25] | ㉗ ▷ [p. 24] | |

English

Thank you for purchasing this YAMAHA product. We hope it will give you many years of trouble-free enjoyment.
For the best performance, read this manual carefully. It will guide you in operating your YAMAHA product.

Contents

Precautions	1	Recording	26
Features	4	Basic recording	26
Preparations and connections	5	Recording from CDs utilizing the EDIT function	28
Installing batteries in the remote control	5	Operating an external unit connected to this system	31
Remote control operation range	5	Various sound control	32
Setting up the speakers	6	General sound control	32
Connections	8	Graphic equalizer	33
Setting the clock	10	Sound field processor	34
Adjusting brightness of the display	10	Using the built-in timer	37
Speaker balance adjustment	11	Timer play	37
CD player operation	12	Timer recording	38
Basic play	13	Sleep timer operation	38
To change the disc play mode	14	Appendix	39
To select another disc	14	Troubleshooting	39
To directly select the desired track	14	Specifications	41
To play the desired track (Skip)	15		
To advance or reverse play rapidly (Search)	15		
To exchange a disc (or discs) while playing (PLAYXCHANGE)	15		
Program play	16		
Repeat play	17		
Random play	18		
Switching the time display	18		
Tuning operation	19		
Automatic tuning	20		
Manual tuning	20		
Automatic preset tuning	21		
Manual preset tuning	22		
Playing back a tape	23		
General information	23		
Basic operation	24		
Winding the tape	25		
Searching for the beginning of the desired selection	25		

For basic source play, the following illustrations on top of the pages will help you look for the section you need.



..... CD play



..... Tuning



..... Tape playback/recording

Precautions: Read this before operating your system

- To assure the finest performance, please read this manual carefully. Keep it in a safe place for future reference.
- Choose the installation location of this system carefully. Avoid placing it in direct sunlight or close to a source of heat. Also avoid locations subject to vibration and excessive dust, heat, cold or moisture. Keep it away from sources of hum such as transformers and electric motors.
- Do not operate this system upside-down. It may overheat, possibly causing damage.
- Never open the cabinet. If something drops into the set, contact your dealer.
- The openings on the main unit cover assure proper ventilation of the main unit. If these openings are obstructed, the temperature inside the main unit will rise rapidly. Avoid placing objects against these openings, and install the main unit in a well-ventilated area to prevent fire or damage.
- Always set the VOLUME control to minimum before starting an audio source play. Increase the volume gradually to an appropriate level after play has started.
- When not planning to use this system for a long period of time (ie., vacation, etc.), disconnect the AC power plug from the wall outlet.
- Grounding or polarization – Precautions should be taken so that the grounding or polarization of this system is not defeated.
- Do not use force on switches, controls or connection wires. When moving the main unit, first disconnect the power plug and the wires connected to other equipments. Never pull the wire itself.
- If an external appliance (TV, radio, etc.) interferes with the operation of this system, move the main unit away from such appliance.
- Do not attempt to clean this system with chemical solvents; this might damage the finish. Use a clean, dry cloth.
- Be sure to read the “Troubleshooting” section regarding common operating errors before concluding that this system is faulty.
- To prevent lightning damage, disconnect the AC power plug and the antenna cable when there is an electric storm.
- Do not plug the AC power plug to the wall socket before you finish all connections.
- Never allow metallic items (e.g. screwdrivers, tools, etc.) to come near the tape deck’s record/playback head assembly. Doing so may not only scratch or damage the head’s mirror-smooth finish, it may change the magnetic characteristics of the heads, causing a deterioration in reproduction performance quality.
- Although the tape deck’s record/playback heads are of high quality with outstanding reproduction characteristics, they can get dirty through the use of old tapes or from dust accumulation over time. This can have a serious effect on reproduction quality. Clean the heads regularly with commonly available head cleaners or with cleaning solutions.
- The voltage to be used must be the same as that specified on this system. Using this system with a higher voltage than specified is dangerous and may result in a fire or other types of accidents causing damage. YAMAHA will not be held responsible for any damage resulting from use of this system with a voltage other than specified.
- The sound level at a given volume setting depends on speaker location and other factors. Care should be taken to avoid exposure to sudden high levels of sound, which may occur when turning this system on with the volume control setting at high. Also avoid exposure to continuous high levels of sound.
- Sudden temperature changes and storage or operation in an extremely humid environment may cause condensation inside the cabinet. Condensation can cause this system to malfunction.
 - To eliminate condensation:
 - **Pickup**
Leave the power on with no disc loaded until normal play becomes possible (about 1 hour).
 - **Tape head**
Leave the power on with no tape loaded until normal playback becomes possible (about 1 hour).
 - Note:**
If condensation forms on the tape head, dirt or dust may accumulate during use.
 - **Remote control**
Wipe off condensation on the transmission window with a soft cloth before operating this system.
- The carousel will turn when you open the disc tray by pressing  **OPEN/CLOSE**; therefore, make sure the carousel stopped moving completely before you perform further operations such as placing or removing a disc from the disc tray. Otherwise, you may cause damage to your discs, or you might injure yourself.

Precautions: Read this before operating your system

This system is not disconnected from the AC power source as long as it is connected to the wall outlet, even if this system itself is turned off. This state is called the standby mode. In this state, this system is designed to consume a certain amount of power.

Note

Please check the copyright laws in your country to record from records, compact discs, radio, etc. Recording of copyright materials may infringe copyright laws.

CAUTION FOR CARRYING THE MAIN UNIT

Be sure not to carry or tip the main unit with discs in it.

CAUTION FOR MOVING THE MAIN UNIT

Before moving the main unit, first remove all discs from the disc tray and close the tray by pressing the  **OPEN/CLOSE** button. After you confirm that "NO DISC" lights up on the display, turn this system into the standby mode by pressing the **STANDBY/ON** switch, and then disconnect the power plug from the AC outlet.

For Canadian Customers

To prevent electric shock, match wide blade of plug to wide slot and fully insert.

This Class B digital apparatus complies with Canadian ICES-003.

WARNING

To reduce the risk of fire or electric shock, do not expose this system to rain or moisture.

To avoid electric shock, do not open the cabinet. Refer servicing to qualified personnel only.

CAUTION

Use of controls or adjustments or performance of procedures other than those specified herein may result in hazardous radiation exposure.

As the laser beam used in this unit is harmful to the eyes, do not attempt to disassemble the cabinet. Refer servicing to qualified personnel only.

Laser component in this product is capable of emitting radiation exceeding the limit for Class 1.

NOTES ABOUT DISCS

To prevent a malfunction of this system:

- Do not use any nonstandard shaped disc (heart etc.) available on the market because it might damage the system.
- Do not use a disc with tape, seals, or paste on it. If you use such a disc, a disc may get stuck in the system, or damage to the system may result.

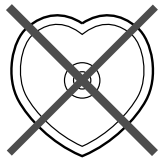

Notes about handling discs

- Always handle the disc with care so that its surface is not scratched.

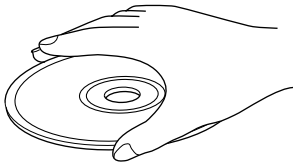

- Discs are not subjected to wear during play, but damage to the disc surface when the disc is being handled can adversely affect the disc's play.
- Be sure to use a felt-tip pen or similar writing tool when writing on the label side of the disc. Do not use a ball-point pen, pencil, or other hard-tipped writing tool, as these may damage the disc and may adversely affect the disc's play.
- Do not warp discs.
- When a disc is not currently being used, remove it from the system and store in an appropriate case.
- When removing or storing a disc, be careful not to scratch the playing surface.

- Discs are not affected by small particles of dust or fingerprints on their playing surface, but even so they should be kept clean. Wipe by using a clean, dry cloth. Do not wipe with a circular motion; wipe straight outward from the center.

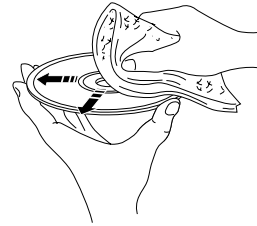

- Do not try to clean the disc's surface by using any type of disc cleaner, record spray, anti-static spray or liquid, or any other chemical-based liquid because such substances might irreparably damage the disc's surface.
- Do not expose discs to direct sunlight, high temperature or high humidity for a long period of time because these might warp or otherwise damage the disc.



To play an 8-cm CD

Place it in the inner recessed area of the disc tray. Do not put a normal (12-cm) CD on top of an 8-cm CD.

Features

General

- 5-Speaker Multi-Channel Audio System (Two Front, One Center and Two Paralleled Rear Speakers)
- High Power Output
Front L, R: 80W + 80W (6Ω) RMS, 0.9% THD, 1 kHz
Center: 80W (6Ω) RMS Output Power, 0.9% THD, 1 kHz
Rear: 25W (6Ω) RMS Output Power, 0.9% THD, 1 kHz
- 4 External Audio/Video Component Connecting Capability
- Multi-Use Timer/Sleep Timer
- SUBWOOFER Output for Low Frequency Expansion
- Remote Control Capability
- BASS BOOST
- 5-Band Spectrum Analyzer
- DOLBY PRO LOGIC and DOLBY 3 STEREO Decoding
- Sound Field Processing (HALL and YMERSSION)
- Test Tone Generator for Easier Speaker Balance Adjustment
- 3 Preset Graphic Equalizer Modes (ROCK, POPS and JAZZ)
- Balance control for the left and right main speakers in DOLBY PRO LOGIC mode

CD Player

- 3-Disc Carousel Type CD Changer
- **PLAY X CHANGE**
Disc changing while playing
- 20-Track Random Access Programming
- Repeat Play for Single Track/Entire Disc/All Discs
- Random Sequence Play

Tape Deck

- Automatic Synchronized Recording with CD
- EDIT Function Useful for Recording CD(s)
- Automatic Reverse
- Dolby B Type Noise Reduction System

Tuner

- 40 Station Preset Tuning
- Automatic Preset Tuning

Installing batteries in the remote control

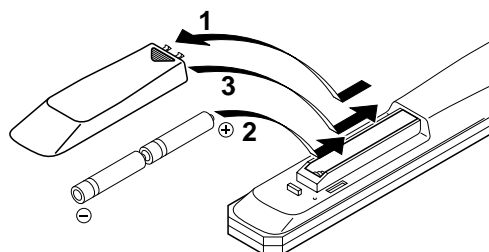

- 1 Turn the remote control over and remove the battery compartment cover by sliding it in the direction of the ∇ mark.
- 2 Insert the batteries (AA, R6, UM-3 type) according to the polarity markings on the inside of the battery compartment.
- 3 Attach the battery compartment cover.

Notes

- Be sure the polarities are correct. (see the illustration inside the battery compartment.)
- Remove the batteries if the remote control is not used for an extended period of time.
- If batteries leak, dispose of them immediately. Avoid touching the leaked material or letting it come in contact with clothing, etc. Clean the battery compartment thoroughly before installing new batteries.
- Be sure to use the same type of batteries.
- Do not use a new battery and an old battery together.

Remote control operation range

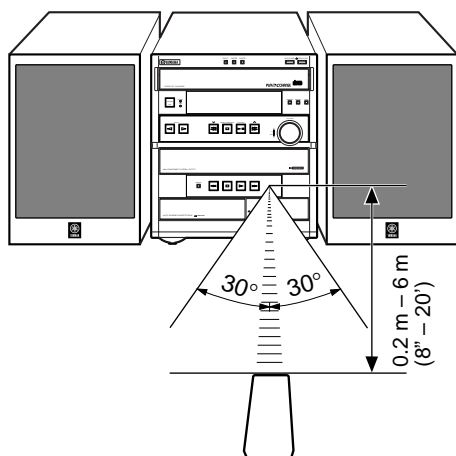

Notes

- The area between the remote control and the main unit must be clear of large obstacles.
- Do not expose the remote control sensor to strong lighting, in particular, an inverter type fluorescent lamp. Otherwise, the remote control may not work properly. If necessary, position the main unit away from direct lighting.

Battery replacement

If you find that the remote control must be used closer to the main unit, the batteries are weak. Replace both batteries with new ones.

Setting up the speakers

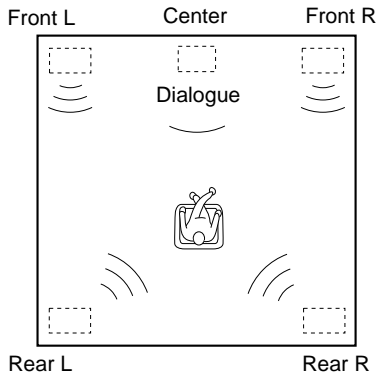

■ 4 channel 5 speaker configuration

This system employs a 5 speaker configuration: 2 front speakers, 2 rear paralleled speakers and a center speaker.

The front speakers are used for outputting main source sound. The rear speakers are for effect and surround sounds when the sound field program **PRO LOGIC** or **HALL** is selected. The center speaker is for center sounds (dialogue etc.) when the sound field program **PRO LOGIC** or **3 STEREO** is selected.

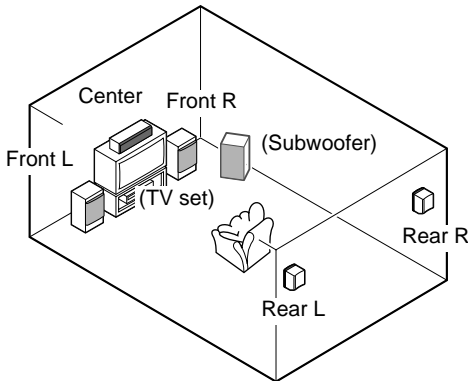

■ Placing the speakers

- Front speakers:** On both sides of and at approximately the same height as the TV.
- Center speaker:** Precisely between the front speakers.
- Rear speakers:** Behind your listening position, facing slightly inward. About 1.8 m (approx. six feet) from the floor.
- Subwoofer:** The position of the subwoofer is not so critical because low bass tones are not highly directional. However, we recommend that you place the subwoofer anywhere in front of your listening position.

■ Mounting the center speaker

Place the speaker on top of the TV or on the floor under the TV or inside the TV rack so that it is stable.

When placing the speaker on top of the TV, put the provided velcro strips at two corners on both the bottom of the speaker and top of the TV to prevent the speaker from falling.

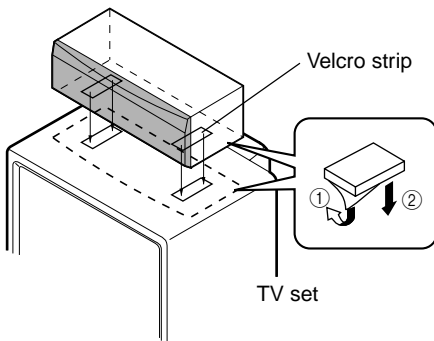

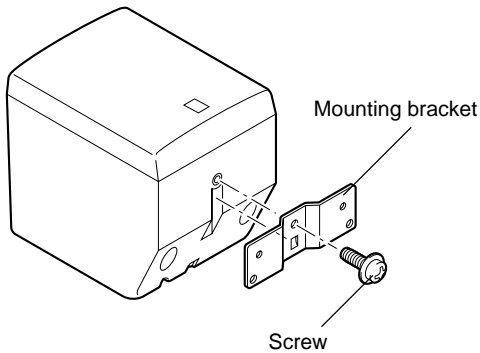
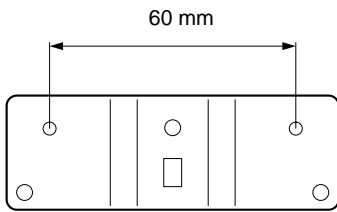

■ Mounting the rear speakers

Mount the rear speakers on a shelf, rack or on the floor, or hang them on the wall.

To mount the rear speakers by using commercially available speaker stands

The provided mounting bracket has 1 pair of screw holes (at an interval of 60 mm). They are for mounting the speaker on a speaker stand.

* These screw holes can be used with M4 screws only.

Note

It is recommended that you connect the speaker cords to the speaker's terminals before attaching the bracket to the speaker.

- 1 Attach the bracket to the bottom of the speaker by using the provided screw so that the convex part of the bracket fits in the grooved part of the speaker as shown left.
- 2 Mount the speaker on the speaker stand by using the screw holes on the bracket.

To mount the rear speakers directly on the wall

If desired, you can hang the speaker on the protruding screws on the wall without using the bracket.

Fasten screws into a firm wall or wall support as shown left, and hang the holes of the speaker on the protruding screws.

* Make sure that the screws are securely caught by a narrow part of the holes.

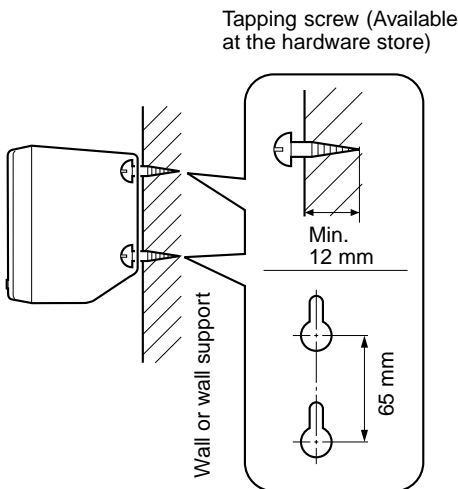

WARNING

- Each of the rear speakers weighs 0.8 kg (1 lbs. 12 oz.). Do not mount them on thin plywood or soft wall surface material, as the screws may come out of the flimsy surface, causing the speakers to fall and be damaged, or result in personal injury.
- Do not fasten the speakers to the wall with nails, adhesives, or other unstable hardware. Long-term use and vibrations may cause them to fall.
- To avoid accidents resulting from tripping over loose speaker cords, fix them to the wall.
- Select a proper position on the wall to mount the speaker and the stand so that no one will injure his/her head or face with the edge of the stand.

Connections

Never plug the AC supply lead of this system into the AC outlet until all connections are completed.

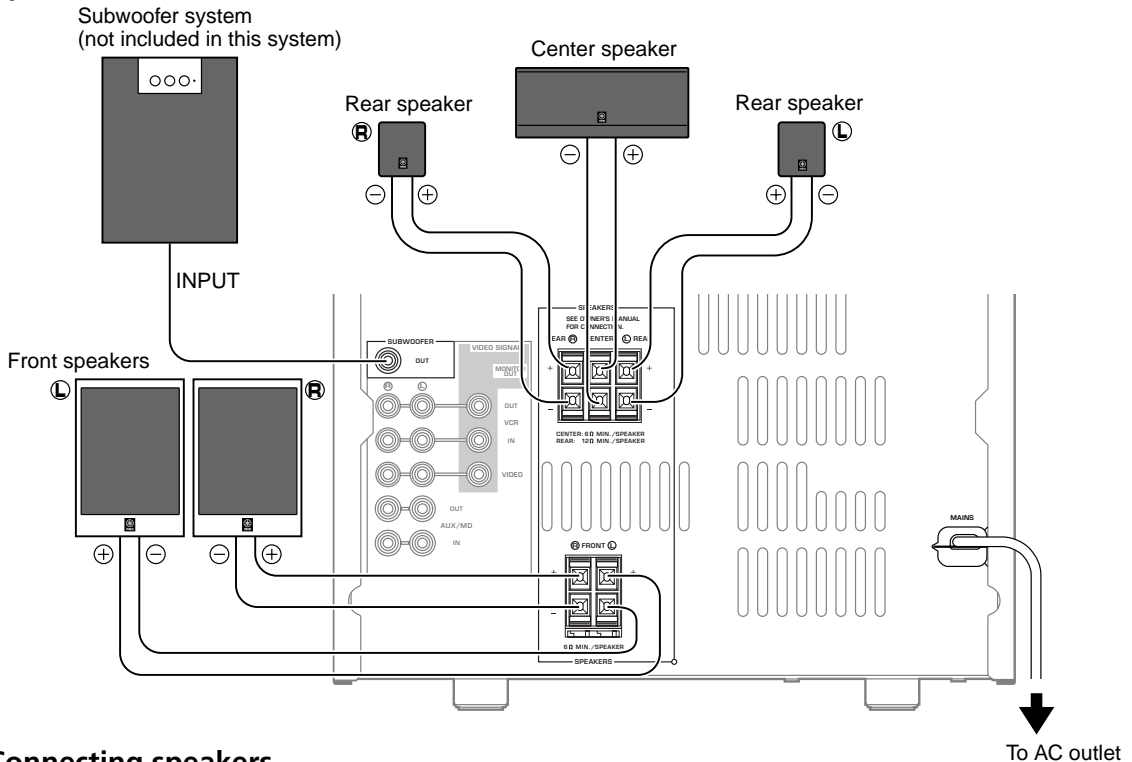

■ Connecting speakers

Connect the speakers to the corresponding speaker terminals on the rear of the main unit by using the speaker cords. Make sure that the polarity of the speaker cords is correct, that is the + and – markings are observed. If these cords are reversed, the sound will be unnatural and lack bass.

On the speakers

Red: positive (+)
Black: negative (–)

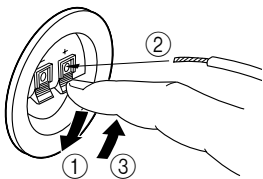

- ① Press the tab.
- ② Insert the bare wire.
[Remove approx. 5mm (1/4") insulation from the speaker wires.]
- ③ Release the tab and secure the wire.

On the main unit

Red: positive (+)
Black: negative (–)

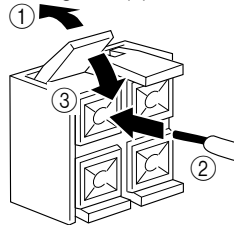

- ① Pull up the tab.
- ② Insert the bare wire.
[Remove approx. 5mm (1/4") insulation from the speaker wires.]
- ③ Press down the tab and secure the wire.

Caution

Do not let the bare speaker wires touch each other as this could damage the amplifier and/or speakers.

When connecting a subwoofer (not included in this system)

You may wish to add a subwoofer to reinforce the bass frequencies.

When connecting a subwoofer to this system, connect the **SUBWOOFER OUT** terminal of this system to the **INPUT** terminal of the subwoofer.

* Ordinary subwoofers, including the Yamaha Active Servo Processing Subwoofer System, are designed so that both the amplifier and subwoofer are contained in the same unit.

* The **SUBWOOFER OUT** terminal outputs low frequencies from the left front, center and right front channels.
(The cut-off frequency of this terminal is 200 Hz.)

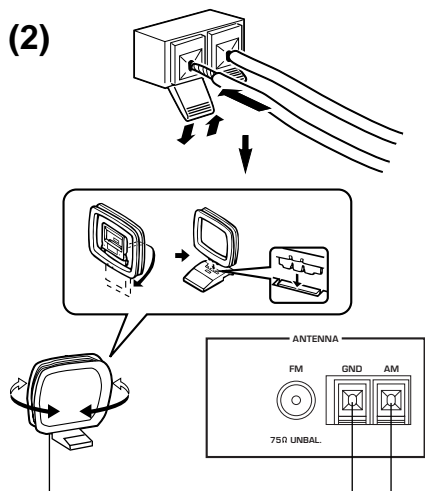
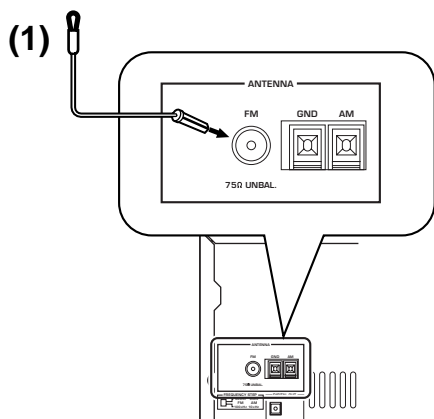

■ Antenna connection

(1) Supplied FM antenna

Connect the FM antenna wire to the corresponding terminal and direct it to the direction where the strongest signal can be received.

(2) Supplied AM loop antenna

Connect the AM loop antenna wires to the corresponding terminals. Position the AM loop antenna for optimum reception.

Notes

- When static is still heard even after adjusting the position of the AM loop antenna, try reversing the wire connections (from the right terminal to the left one, and vice versa).
- The AM loop antenna should be placed apart from the main unit. The antenna may be hung on a wall.

Using an external antenna

- If you need better reception, use an external FM antenna instead of an indoor FM antenna. Consult your dealer.
- Use an external AM antenna if you need better reception. Consult your dealer.

■ Connecting external components

This system can be connected with external audio and video components. Make connections between this system and the components using RCA pin plug connector cables, by correctly connecting **L** (left) to **L** and **R** (right) to **R**. Also, refer to the owner's manual for the component to be connected to this system.

* A digital-to-digital recording is possible from a CD played on the built-in CD player to an MD (or tape) on an external MD recorder (or DAT) by connecting the **DIGITAL OUT (OPTICAL)** terminal on the rear of the main unit to the MD recorder (or DAT).

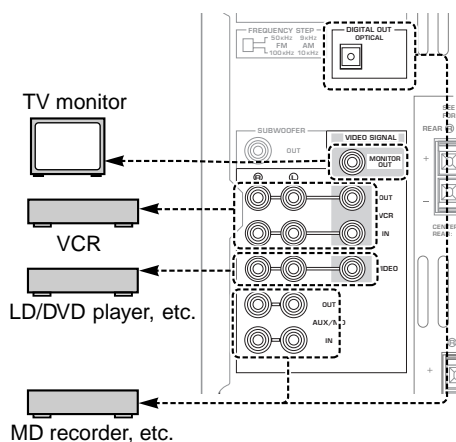

Setting the clock

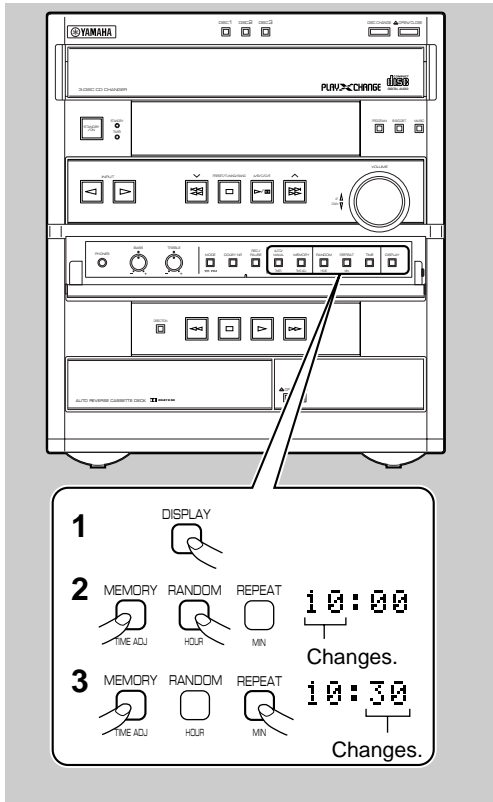

- Australia model uses a 24-hour display. U.S.A. and Canada models use a 12-hour display. For General model, either the 24-hour display or the 12-hour display [shown by "AM (PM) 12:00"] is selected depending on the setting of the **FREQUENCY STEP** switch on the rear panel.
- * Set this system into the standby mode and disconnect the AC supply lead when switching the **FREQUENCY STEP**.

Note

In the event of a power failure or when the AC supply lead is disconnected, the time display will go out; however, the clock will function for about 5 minutes without any power supply. Otherwise, the time display will flash on and off to indicate that time must be reset.

Adjusting brightness of the display

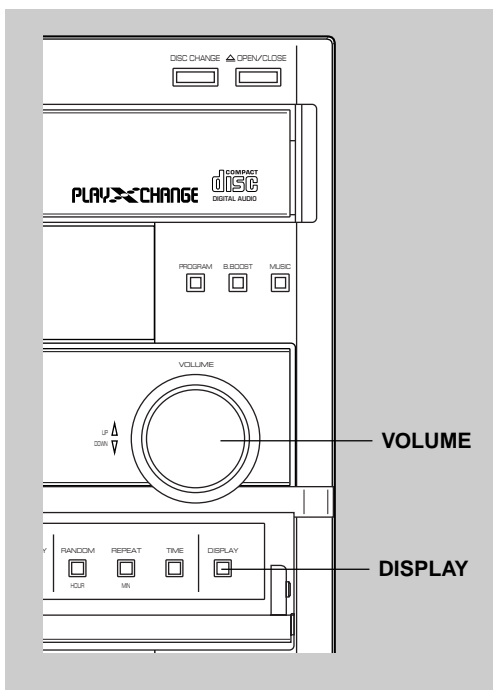

If desired, you can adjust the brightness of the display.

Press and hold **DISPLAY** for more than 2 seconds so that "DIMMER ±0" appears on the display.

While holding down **DISPLAY**, turn **VOLUME** clockwise to increase or counterclockwise to decrease brightness.

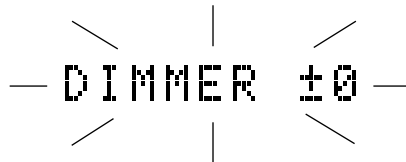

Control range: ±0 to -6 (Preset value: ±0)

Speaker balance adjustment

You can adjust the sound output level balance between the front, center, and rear speakers using the built-in test tone generator. This is important for the best performance of the built-in Dolby Pro Logic surround decoder.

You can adjust the sound output level of center and rear speakers from -21 to +10 and the balance of the sound output levels of the left and right front speakers from L-6 to R-6.

The adjustment of each speaker output level should be done from your listening position with the remote control. Otherwise, the result may not be satisfactory.

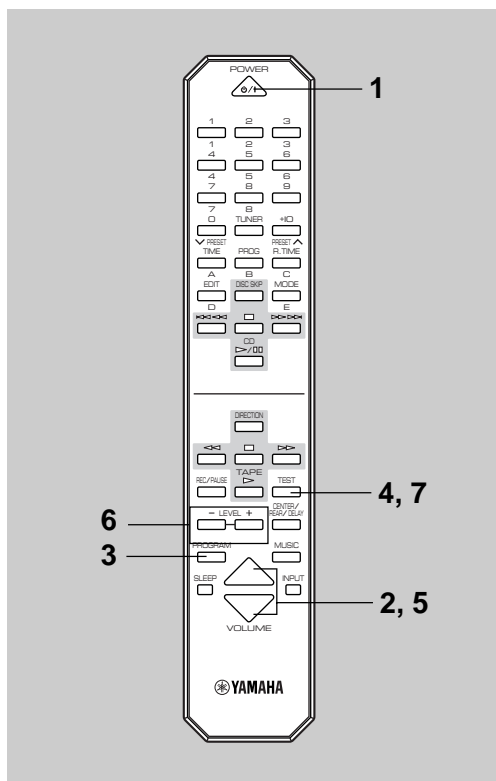

- 1 Turn on the power.
- 2 Turn down the volume to minimum.
- 3 Press **PROGRAM** repeatedly until “**PRO LOGIC**” lights up on the sound field program indicator.
- 4 Press **TEST**.
 - * “TEST” flashes on and off on the display.
- 5 Press **VOLUME** \triangle to increase the volume.

You will hear a test tone (like pink noise) from the left front speaker, the center speaker, the right front speaker, and then the rear speakers, for about 2.5 seconds each. The display changes as shown below.

```

LEFT<<<<  ->  >CENTER<
      ^
<SURROUND> ->  >>>RIGHT
      v
    
```

* The test tone from the left rear speaker and the right rear speaker will be heard at the same time.

- 6 Press **LEVEL+/-** to adjust the sound output level of the center speaker when “>CENTER<” is displayed.
 Press **LEVEL+/-** to adjust the sound output level of the rear speakers when “<SURROUND>” is displayed.
 Press **LEVEL+/-** to adjust the balance of the output volume level from the left and right front speakers when “LEFT<<<<” is displayed. Press **+** for left and **-** for right front speakers to compensate for the sound imbalance caused by poor speaker location or unique listening room acoustics.

example)



- 7 When the adjustments are finished, press **TEST** to cancel the test tone.
 - * “TEST” disappears from the display.

Note

Once you have completed these adjustments, you can adjust the whole sound level on your audio system by using **VOLUME** on the main unit or the remote control.

CD player operation

Display information

Each indicator mentioned with a number on pages 13–18 corresponds to the indicator with the same number on this page.

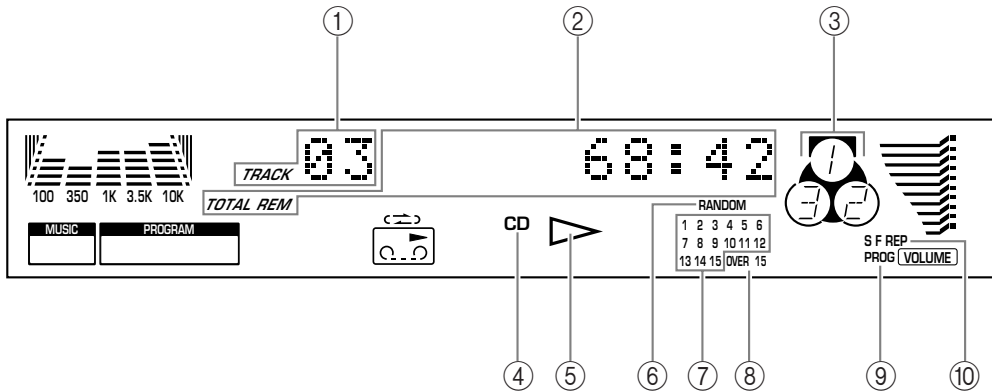

① **TRACK (track number)**

② **Time display**

③ **Disc indicator**

The number on the top of this indicator shows the currently selected disc.

④ **CD (input source indicator)**

⑤ **(play)**

⑥ **RANDOM**

⑦ **Music calendar**

Track numbers on the currently selected disc will light up (up to the number 15).

⑧ **OVER 15**

This indicator will light up when the currently selected disc has more than 15 tracks.

⑨ **PROG (program)**

⑩ **(S, F) REP [(single, full) repeat]**

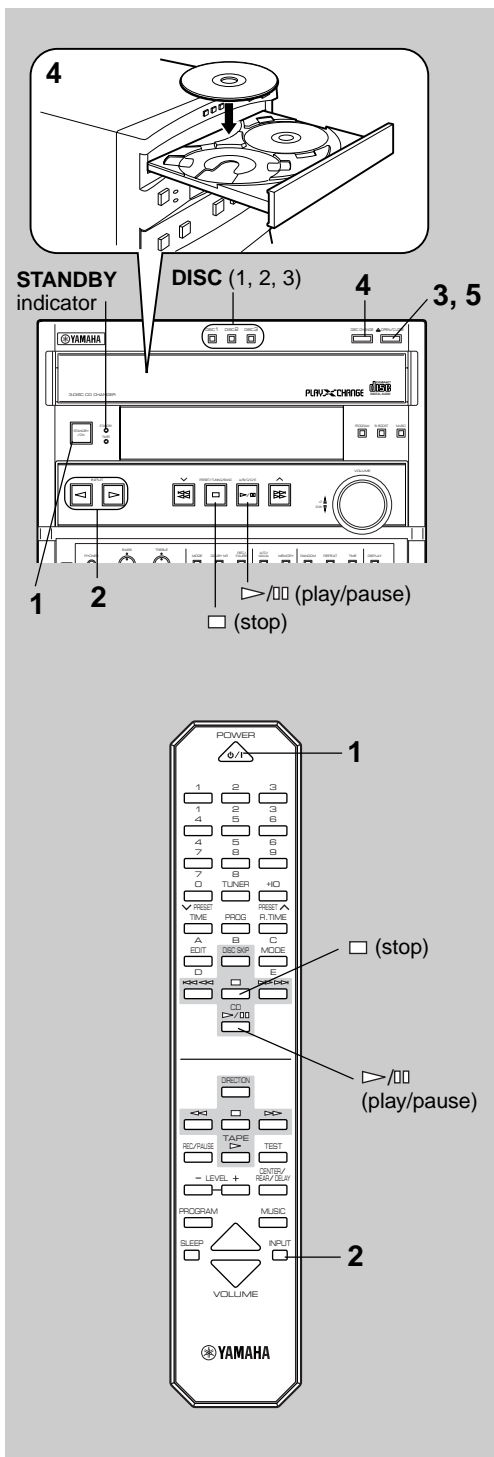

Basic play

- 1 Turn on the power.
- 2 Press **INPUT** \triangleright or \triangleleft (or **INPUT** on the remote control) until “CD” (2) appears on the display.
- 3 Press \triangle **OPEN/CLOSE** to open the disc tray.

* The carousel will turn when you open the disc tray by pressing \triangle **OPEN/CLOSE**; therefore, make sure the carousel stopped moving completely before you perform further operations. Otherwise, you may cause damage to your discs, or you might injure yourself.

- 4 Place discs on the table with label side facing upward.
 - * Up to three discs can be loaded on the table.
 - To load the third disc, rotate the disc table by pressing **DISC CHANGE** on the front panel.
 - * 8 cm (3”) discs can be played without an adaptor.
 - * The disc placed on the right side is played first.
- 5 Press \triangle **OPEN/CLOSE** to close the disc tray.
 - * If the selected disc is a CD, the total number of tracks (1) and the total playing time of the disc (2) will be displayed for several seconds.
 - * If the disc contains more than 15 tracks, the “OVER 15” indicator (8) will light up.
 - * If the disc tray is closed by pushing the front edge of the tray, play will begin automatically.

- 6 Press \triangleright /||| to begin play.

To pause

Press \triangleright /|||.

To stop play

Press |||.

To finish using this system

Turn this system into the standby mode by pressing **STANDBY/ON** (or **POWER** ϕ /I on the remote control). The **STANDBY** indicator will light up and the display will go out.

Direct operation

DISC (1, 2 or 3) on the front panel and \triangleright /||| on the remote control can be used when this system is in the standby mode or another input source is selected.

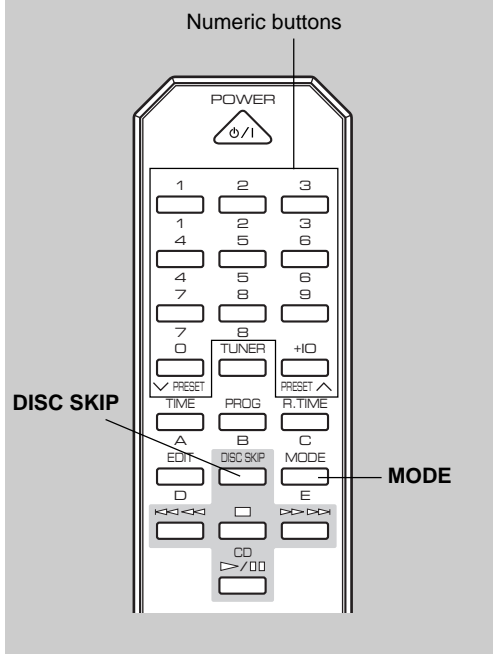
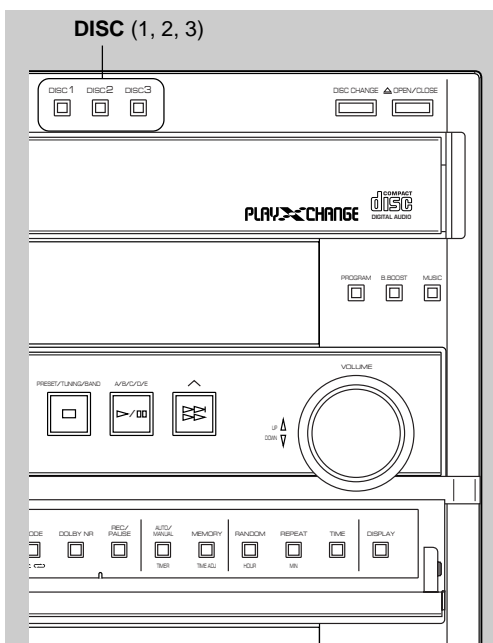

To change the disc play mode

If necessary, change the disc play mode by pressing **MODE** on the remote control.

All disc play mode: All discs on the disc tray are played sequentially (originally set to this mode).

Single disc play mode: Only the designated disc is played.

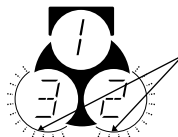

Lights up only when the all disc play mode is selected.

To select another disc

Press **DISC SKIP** on the remote control once or more (so that the corresponding disc number comes to the top position of the disc indicator (③)).

Pressing **DISC (1, 2 or 3)** will select the disc directly, and play will automatically begin from track 1.

To directly select the desired track

By using the numeric buttons on the remote control, any track you wish to listen to can be played directly.

Use the numeric buttons to select the desired track. Play will begin automatically.

A. For example, to choose track 5

Press **5**.

B. For example, to choose track 12

(1) Press **+10**.

(2) Within a few seconds, press **2**.

C. For example, to choose track 20

(1) Press **+10**.

(2) Within a few seconds, press **+10** again.

(3) Within a few seconds, press **0**.

Note

If you select a track number higher than the number of tracks on the disc, the last track of the disc may be played.

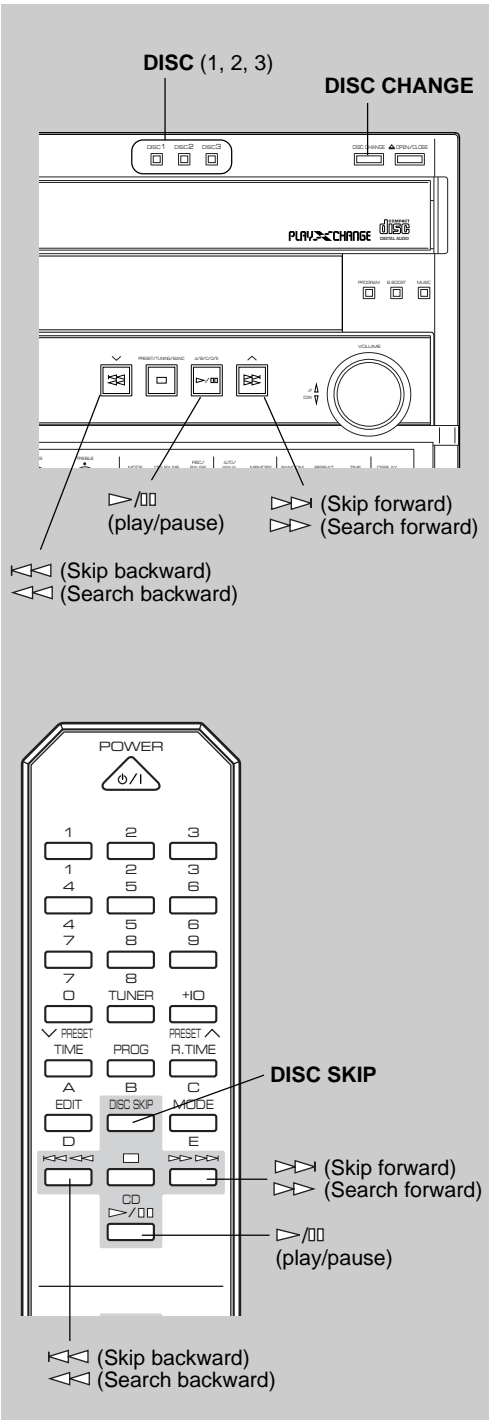

To play the desired track (Skip)

To advance to the next track

During play, press **SKIP FORWARD** (**SKIP FORWARD**). Pressing **SKIP FORWARD** (**SKIP FORWARD**) repeatedly advances to other tracks.

To return to the beginning of current track

During play, press **SKIP BACKWARD** (**SKIP BACKWARD**) once.

To return to previous track

During play, press **SKIP BACKWARD** (**SKIP BACKWARD**) twice in succession to return to the previous track.

Repeatedly press **SKIP BACKWARD** (**SKIP BACKWARD**) to return to other previous tracks.

Note

This function can also be performed while the CD player is being stopped. Press **PLAY/PAUSE** when the desired track number appears on the track number display. Play will begin from the beginning of that track.

To advance or reverse play rapidly (Search)

Press and hold **SKIP FORWARD** (**SKIP FORWARD**) to advance play rapidly, and **SKIP BACKWARD** (**SKIP BACKWARD**) to reverse play rapidly.

To exchange a disc (or discs) while playing (PLAYXCHANGE)

During play, you can open the disc tray by pressing **DISC CHANGE** without interrupting play. In this case, however, pressing **DISC SKIP** or **DISC (1, 2 or 3)** is invalid.

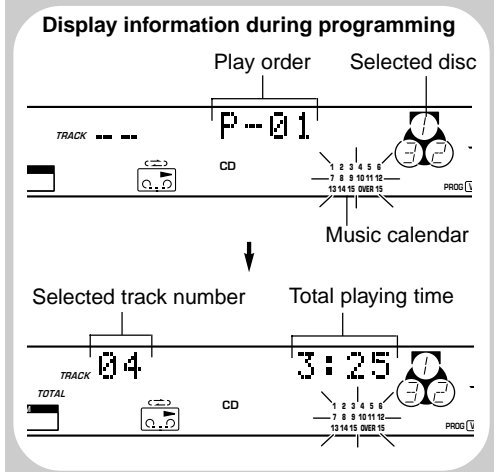
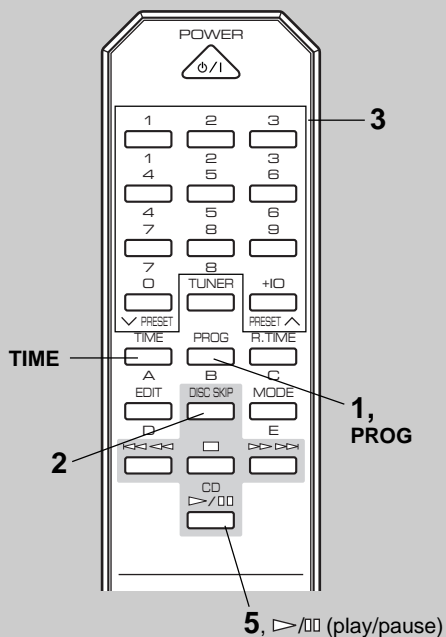
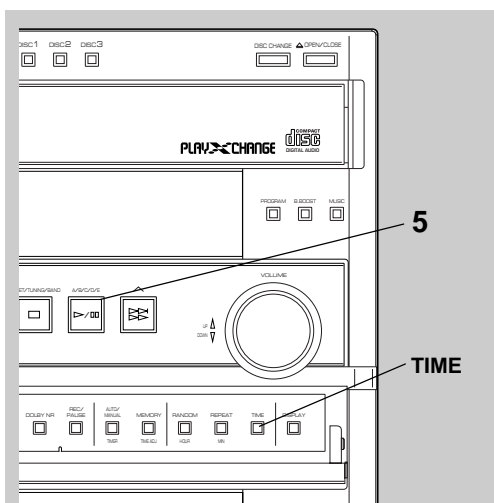

Program play

You can program up to 20 tracks in any desired order.

- When the CD player is being stopped, press **PROG** to prepare for programming.
 - * “PROG” (⑨) and “P-01” (②) will light up on the display, and all track numbers on the selected disc (⑦) will begin blinking.
- If necessary, select the desired disc by pressing **DISC SKIP**.
 - * Just after you change the disc, the CD player reads the contents of the newly selected disc for a few seconds. If you go on to the next step during this internal operation, “WAIT” (②) appears on the display and your operation is canceled.
- Use the numeric buttons to select the desired track number.
 - * The selected track number (①) and the total play time of the programmed tracks (②) will light up on the display, and it will soon be replaced by the display of the next play order (②). Programmed track numbers on the selected disc will stop flashing and light up on the music calendar (⑦).
 - * Pressing **TIME** displays the total play time of the programmed tracks (②) for about 1 second, and then it is replaced by the display of the next play order (②).
- Repeat steps 2 and 3 to program other tracks.
- Press **▷/00** to start the program play.

Notes

- If the total time of the programmed tracks becomes 100 minutes or more, the first digit will not be displayed.
- The total time of the programmed tracks will not be displayed, if track number 16 or higher is programmed.
- Skip (◀◀/▶▶) can be performed during play, but only within the range of the programmed tracks.
- Search (◀◀/▶▶) can be performed during play to search all tracks, including unprogrammed tracks.

To cancel a programmed sequence

Press **□** while the CD player is being stopped.

To check (and correct) program data

- Press **PROG** when the CD player is being stopped.
- Every time **▶▶** is pressed, the track numbers and sequential order of the programmed tracks can be checked one after another. The display of the track number can be returned (sequentially in reverse order) by pressing **◀◀**.
- If you want to correct the program data, press a numeric button to select the track to replace the one displayed. The previously programmed track will be cleared from the memory and the new one will be programmed.
To complete the correction, press **PROG** or **▷/00** once again.

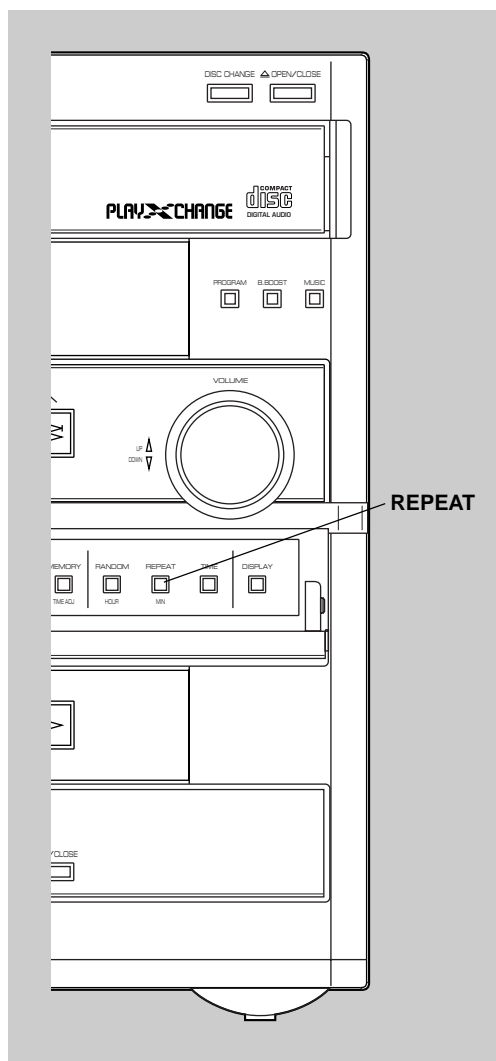

Repeat play

All discs, a disc, a single track or a programmed sequence can be repeated continuously.

Press **REPEAT** once or more to select the desired repeat play mode so that the S REP or F REP indicator (Ⓢ) is illuminated.



Repeat play modes

SINGLE REPEAT (S REP)

A single track is played repeatedly.

* This is also available in the program play mode and the random play mode. (If the repeat play mode is switched off, the program play mode or the random play mode will be resumed.)

FULL REPEAT (F REP)

When the CD player is in the single disc play mode:

The designated disc is played repeatedly.

* In the random play mode, the selected disc is repeatedly played, but the order of tracks is different each time.

When the CD player is in the all disc play mode:

All discs on the disc tray are played repeatedly.

* In the random play mode, the random play is performed among all discs and repeated with a different order of tracks each time.

Note

In the program play mode, a sequence of programmed tracks is played repeatedly.

To cancel the repeat play

Press **REPEAT** repeatedly until the (S, F) REP indicator (Ⓢ) goes out.

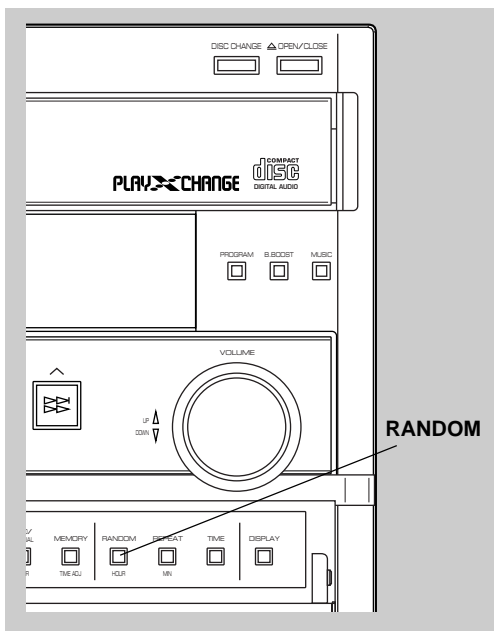

Random play

Tracks on a selected disc or all discs on the disc tray can be played randomly.

- 1 If necessary, switch the disc play mode by pressing **MODE**.
 - * If the single disc play mode is selected, select the desired disc by pressing **DISC SKIP**.
- 2 Press **RANDOM** to begin random play.
 - * The "RANDOM" indicator (⑥) will light up.

To cancel the random play

Press **□**, or press **RANDOM** so that the "RANDOM" indicator (⑥) will go out.

Note

This feature will not function during programming or program play.

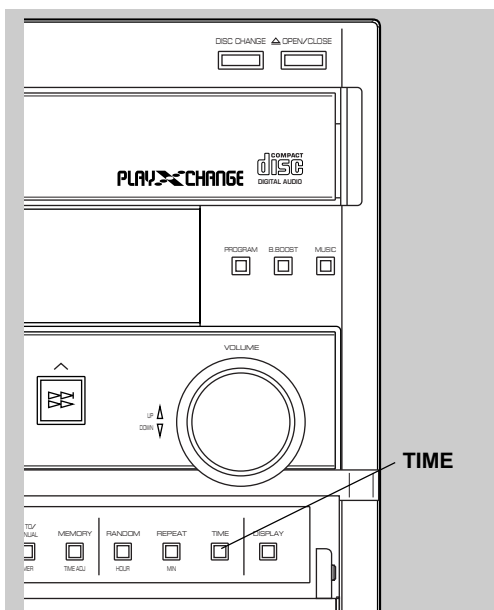

Switching the time display

Every time **TIME** is pressed, the display will change as described below.

[Example]

When the second track is being played:

The elapsed play time for the current track will be displayed.

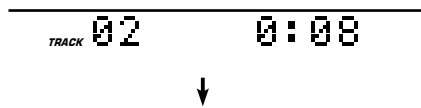

The remaining play time for the current track will be displayed.

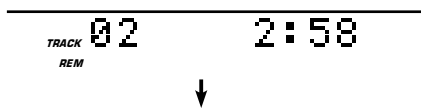

The total play time of the disc will be displayed.

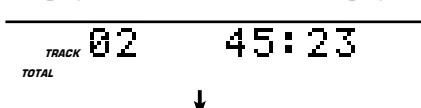

The total remaining play time of the disc will be displayed.

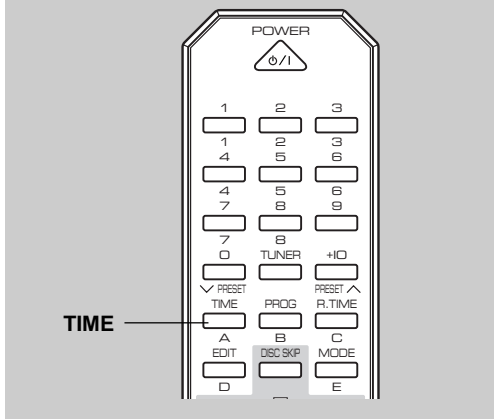
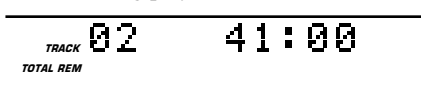

Tuning operation

Display information

Each indicator mentioned with a number on pages 20–22 corresponds to the indicator with the same number on this page.

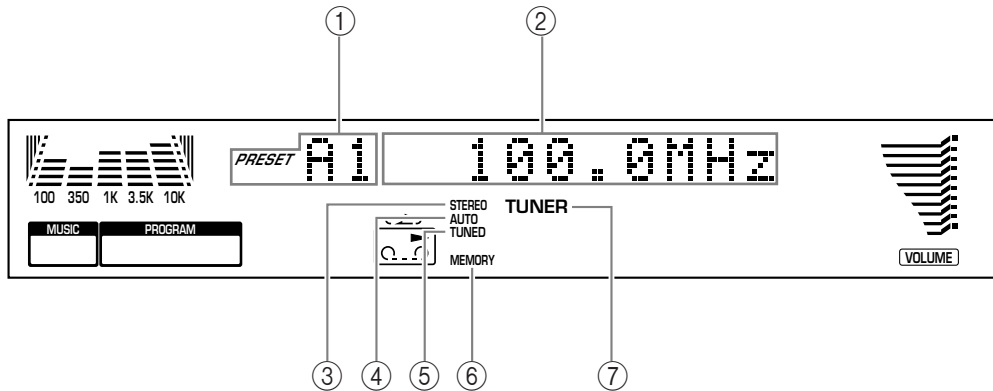

- ① Preset station group and number indicator
- ② Multi-information display
- ③ STEREO
- ④ AUTO
- ⑤ TUNED
- ⑥ MEMORY
- ⑦ TUNER (input source indicator)

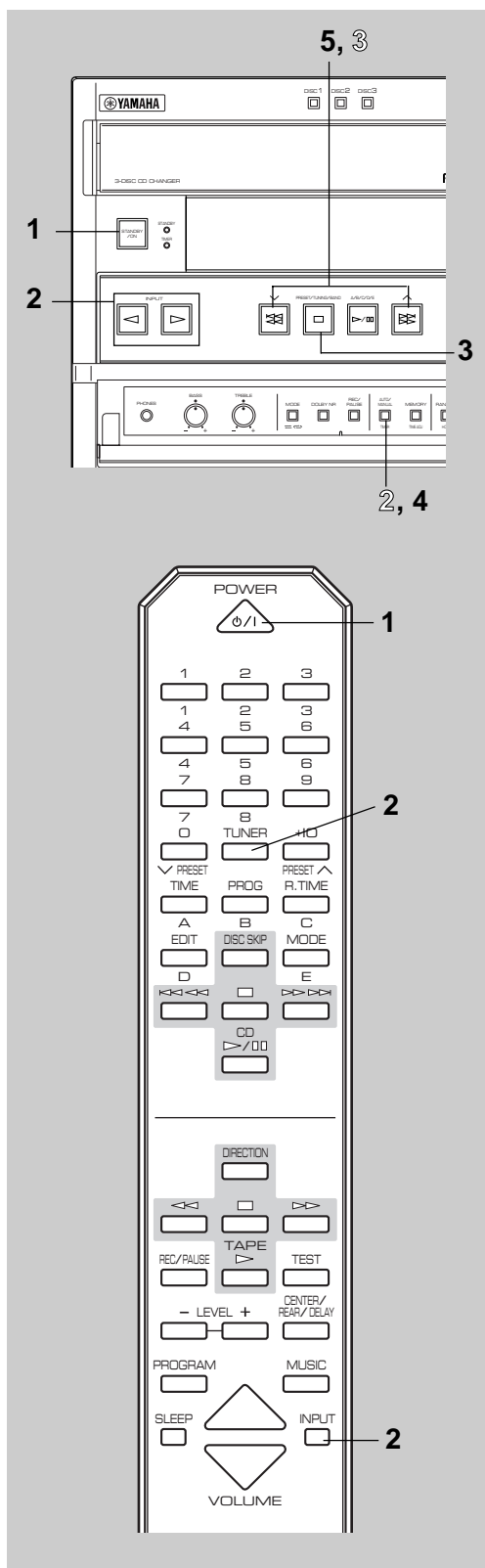

Automatic tuning

- 1 Turn on the power.
- 2 Press **INPUT** \triangleright or \triangleleft until "TUNER" (②, ⑦) appears on the display, or simply press **TUNER** on the remote control.
- 3 Select the reception band (FM or AM) by pressing **PRESET/TUNING/BAND** (or **TUNER** on the remote control), and confirm it on the display (②).
 - * Do not select the preset tuning mode (in which "PRESET" (①) lights up on the display).
- 4 Press **AUTO/MANUAL** so that "AUTO" (④) lights up on the display.
- 5 Press \wedge to tune to a higher frequency, or press \vee to tune to a lower frequency.
(When tuned in to a station, "TUNED" (⑤) will light up on the display.)
- 6 If the station where tuning search stopped is not the desired one, follow step 5 again.
 - * If the tuning search does not stop at the desired station, change to the Manual tuning method as described below.
 - * "STEREO" (③) will light up when an FM stereo broadcast with sufficient signal strength is received.

Direct operation

TUNER on the remote control will work if it is pressed when this system is in the standby mode or another input source is selected.

Manual tuning

- 1 Follow steps 1–3 of the Automatic tuning method.
- 2 Press **AUTO/MANUAL** so that "AUTO" (④) disappears from the display.
- 3 Press and hold \wedge to tune to a higher frequency, or press and hold \vee to tune to a lower frequency.
Release the button just before reaching the desired frequency, and then press it repeatedly until the desired frequency appears.
(When tuned in to a station, "TUNED" (⑤) will light up on the display.)

Note

If you tune in to an FM station manually, it is received in monaural to increase the signal quality.

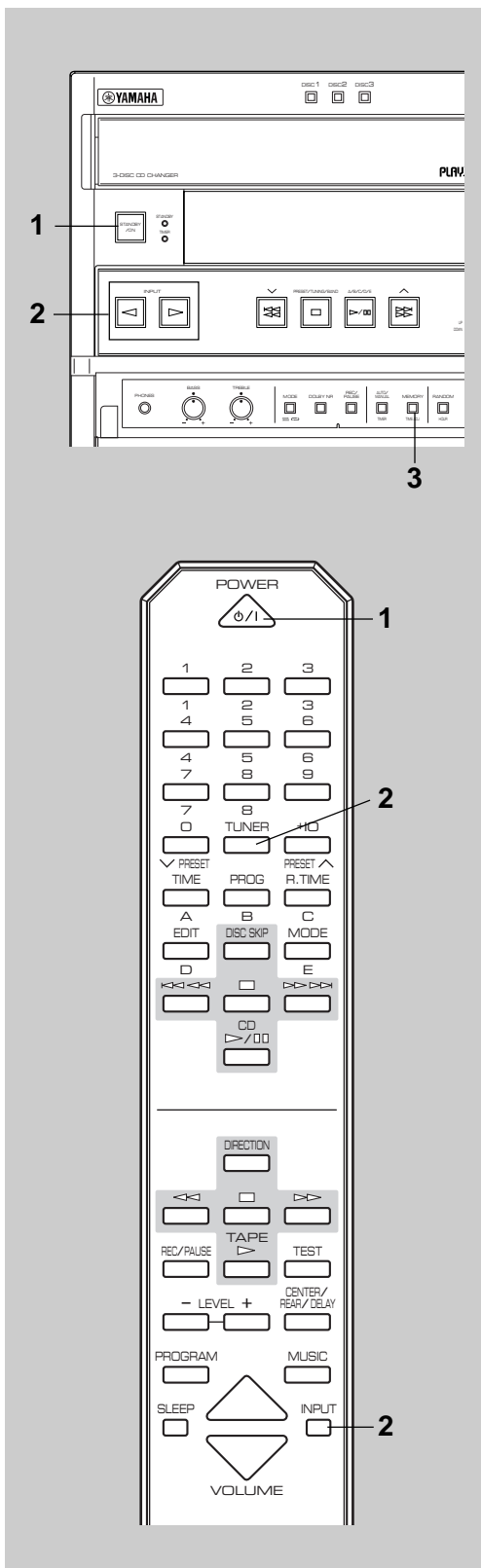

Automatic preset tuning

You can make use of an automatic preset tuning function. With this function, the built-in tuner performs automatic tuning. Up to 40 stations [8 stations x 5 groups (A, B, C, D and E)] are stored automatically.

- 1 Turn on the power.
- 2 Press **INPUT** \triangleright or \triangleleft until “TUNER” (②, ⑦) appears on the display, or simply press **TUNER** on the remote control.
- 3 Press and hold **MEMORY** for more than 2 seconds.
 - * The “MEMORY” (⑥) and “AUTO” (④) indicators flash.

The tuner performs automatic tuning and searches for FM stations first and then AM stations. Received stations are programmed sequentially to A1, A2, A3 and so on.

When the automatic preset tuning is completed;

The display shows the frequencies of the first preset station (stored to A1).

If you want to check the contents and the number of preset stations, follow the procedure in the section “To recall a preset station” on page 22.

To recall a preset station

Simply follow the procedure in the section “To recall a preset station” on page 22.

Notes

- The automatic preset tuning search will be performed through all frequencies until 40 stations are stored. If the number of received stations is less than 40, the search will stop after searching all frequencies.
 - * Since FM stations are searched for first, there may be a case that 40 preset stations are occupied by FM stations only.
- With this function, only stations with sufficient signal strength are stored automatically. If the station you want to program is weak in signal strength, tune in to it with the Manual tuning method (in monaural) and program it by following the procedure in the section “To store stations” on page 22.
- You can replace a preset station with another FM or AM station manually by simply following the procedure in the section “To store stations” on page 22.

Memory back-up

The memory back-up circuit prevents the programmed data from being lost even if the AC supply lead is disconnected from the AC outlet or the power is cut due to temporary power failure. If, however, the power is cut for more than one week, the memory may be erased. If so, it can be re-programmed by simply following the Preset tuning steps.

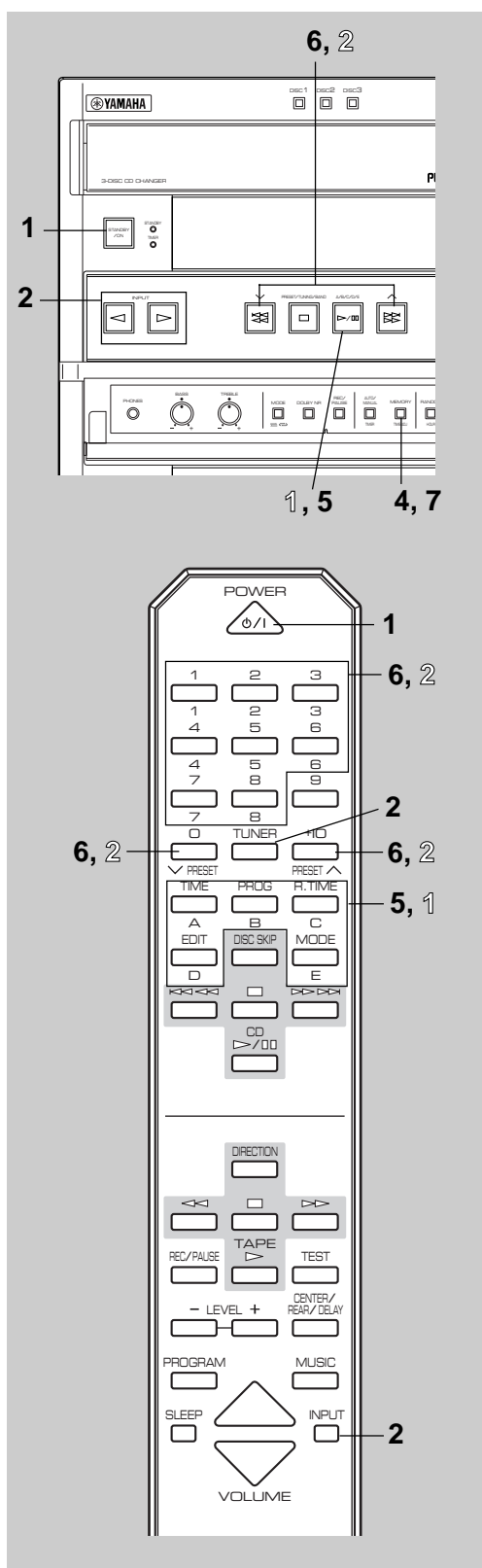

Manual preset tuning

The built-in tuner can store station frequencies selected by tuning operation. With this function, you can select any desired station only by calling the corresponding preset station number. Up to 40 stations (8 stations x 5 groups) can be stored.

■ To store stations

- 1 Turn on the power.
- 2 Press **INPUT** \triangleright or \triangleleft until "TUNER" (②, ⑦) appears on the display, or simply press **TUNER** on the remote control.
- 3 Turn in to the desired station.
- 4 Press **MEMORY**.
* "MEMORY" (⑥) and "PRESET" (①) will flash on the display for about 5 seconds.
- 5 Select the desired group (A – E) of preset stations by pressing **A/B/C/D/E** before "MEMORY" (⑥) goes out. Confirm the selection on the display.
- 6 Select a preset station number by pressing \vee or \wedge repeatedly or pressing a numeric button (1 to 8) before "MEMORY" (⑥) goes out.
- 7 Within about 5 seconds, press **MEMORY** again.

■ To recall a preset station

- 1 Select a group of preset stations by pressing **A/B/C/D/E**.
- 2 Select the desired preset station number by pressing \vee or \wedge repeatedly or pressing a numeric button (1 to 8).

Notes

- A new setting can be programmed in place of the former one.
- As for the preset stations, the setting of **AUTO/MANUAL** is stored along with the station frequency.

Playing back a tape

Display information

Each indicator mentioned with a number on pages 24–30 corresponds to the indicator with the same number on this page.

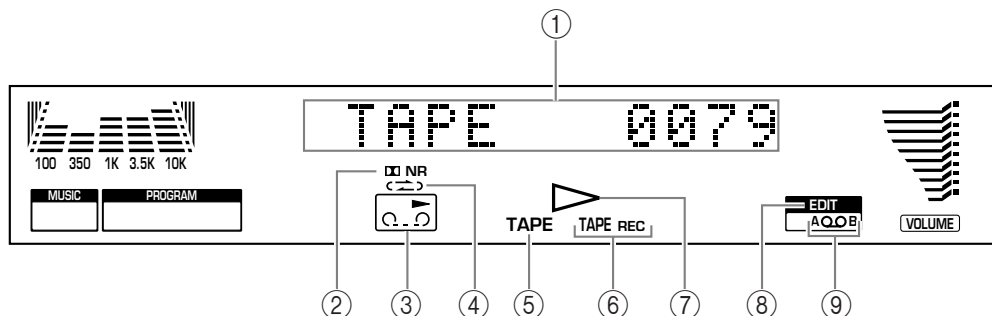

- | | | |
|----------------------------|------------------------------------|-----------------------|
| ① Tape counter | ④ Reverse mode indicator | ⑦ ▷ (play) |
| ② NR (DOLBY NR) | ⑤ TAPE
(input source indicator) | ⑧ EDIT |
| ③ Tape direction indicator | ⑥ TAPE REC | ⑨ Tape side indicator |

General information

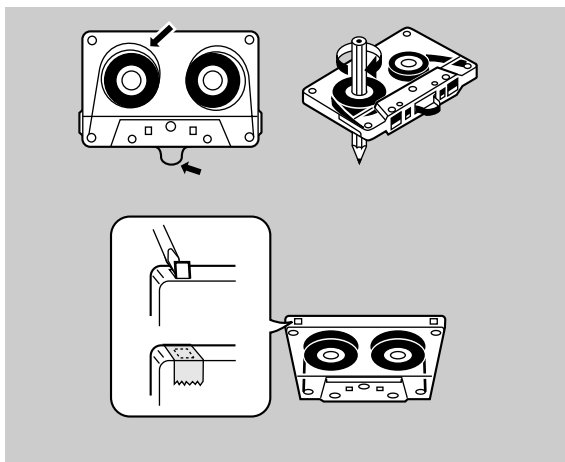

- Do not use C-120 tapes or poor quality tapes, since they can cause malfunctions.
- Before loading a tape on the tray, tighten the tape slack with a pen or pencil.
- Tapes have removable tabs which prevent accidental recording or erasing from taking place. Removing the tab on the top left corner protects the side facing you from erasure. Cover the tab holes with adhesive tape to erase or record again.
- The tape deck features an automatic tape selector. Just load the tape, and the type of tape being used will be sensed automatically.
- The tape deck can play back metal tapes as well as normal or high position tapes; however, recording cannot be done on metal tapes with good sound quality.

Dolby B Type Noise Reduction

Dolby noise reduction is an extremely effective method of reducing undesirable background hiss on tapes. The built-in tape deck incorporates Dolby B type noise reduction system.

DOLBY NR is useful for both recording and playback; be sure that the same noise reduction is used on recording and playback.

Dolby noise reduction is manufactured under license from Dolby Laboratories Licensing Corporation. "DOLBY" and the double-D symbol  are trademarks of Dolby Laboratories Licensing Corporation.

About the tape counter

The tape deck is equipped with a tape counter that is useful for searching and locating a desired point on the tape. The tape counter is shown on the display.

Pressing  (stop) when the deck is being stopped will reset the tape counter to "0000".





Playing back a tape

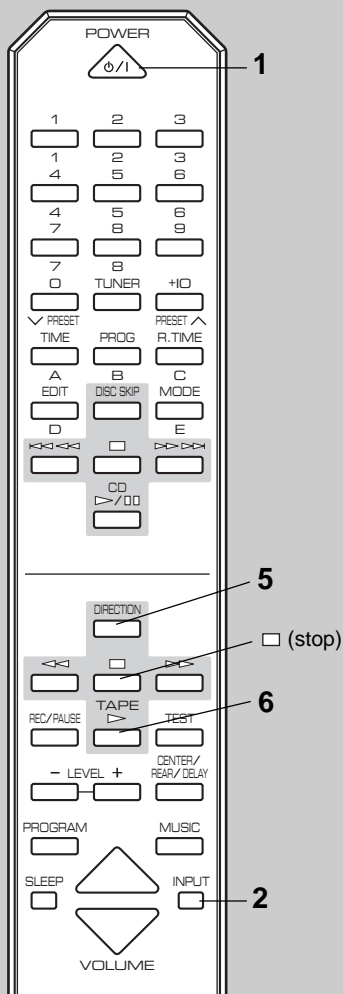
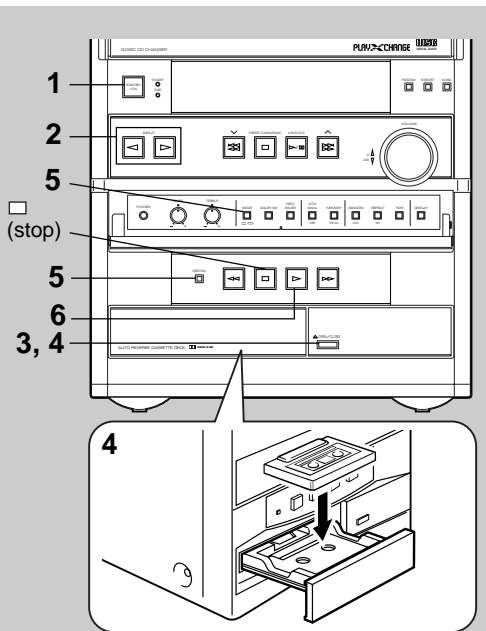

Basic operation

- 1 Turn on the power.
- 2 Press **INPUT** \triangleright or \triangleleft until "TAPE" (①, ⑤) appears on the display.
- 3 Open the tray by pressing \triangle **OPEN/CLOSE**.
- 4 Load the tape on the tray with side A facing upward, and close the tray by pressing \triangle **OPEN/CLOSE** or pushing the front edge of the tray gently.
- 5 Press **MODE** or **DIRECTION** to change the current setting if necessary.

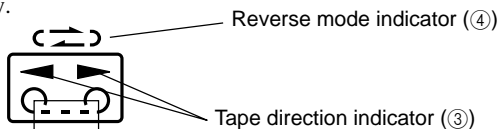

Moves slowly in the current tape running direction during playback.

MODE	\rightarrow	\rightarrow ↪	↺↻
DIRECTION			
	Side A only	Side A → Side B	Side A → Side B ↑ (Repeats 8 times) Starts from side A.
	Side B only	Side B only	Side B → Side A ↑ (Repeats 8 times) Starts from side B. (Side A is not played the first time.)

- 6 Press \triangleright .
Playback begins.

To stop playback

Press \square .

To remove the tape

Open the tray by pressing \triangle **OPEN/CLOSE**.

Direct operation

\triangleright and \triangle **OPEN/CLOSE** will work if they are pressed when this system is in the standby mode or another input source is selected.

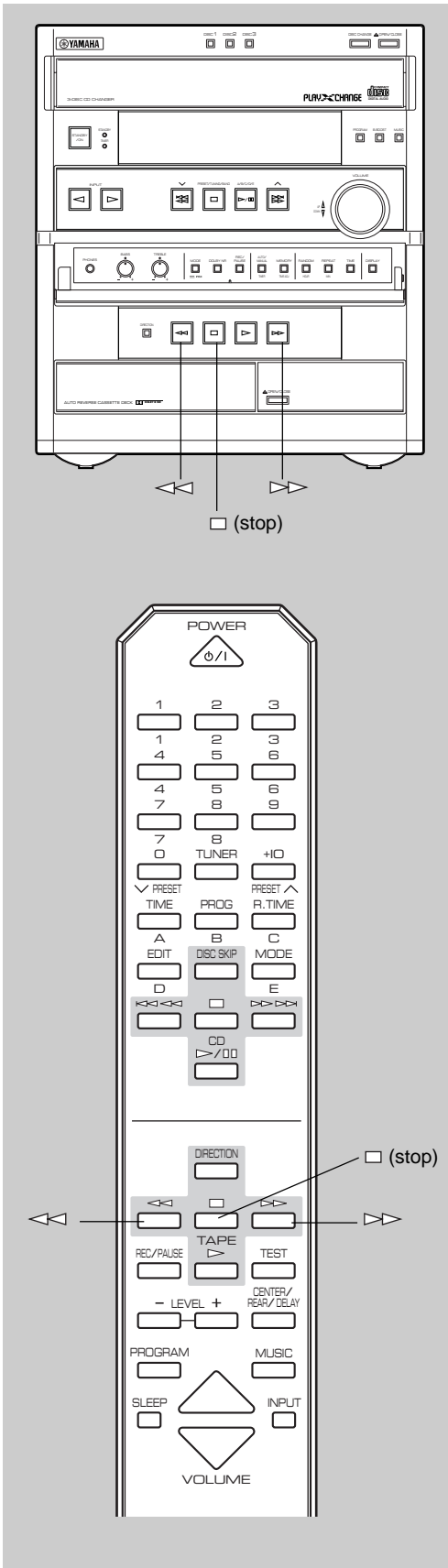

Winding the tape

1 Press ◀◀ or ▶▶ to wind the tape.

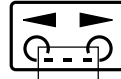

Moves rapidly in the current tape running direction while winding.

2 Press □ to stop.

Note

When the tape is wound to the end, the tape deck will then function as described below.

- ⏮ : The tape stops at the end.
- ⏮▶ : If the winding direction is ▶, playback automatically starts from the reverse side when the tape reaches the end.
- ◀⏭ : If the winding direction is ◀, the tape stops at the end.
- ◀⏮▶ : When the tape reaches the end, playback automatically starts from the reverse side.

Searching for the beginning of the desired selection

Press ◀◀ or ▶▶ during playback.

The tape deck will find a blank interval between selections and start playback automatically.

To listen to the same selection

- Press ◀◀ if the direction of the current playback is ▶.
- Press ▶▶ if the direction of the current playback is ◀.

To listen to the next selection

- Press ▶▶ if the direction of the current playback is ▶.
- Press ◀◀ if the direction of the current playback is ◀.

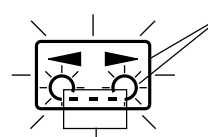

Blinks on and off.

Moves rapidly in the current tape running direction while searching.

Notes

- This function may not work for tapes with
 - * Material with long pauses or quiet passages.
 - * Low recording levels or excessive noise.
 - * Pauses of less than 4 seconds between selections.
- If searching is carried out near the beginning or the end of a selection, the searching may not be done successfully.

Recording

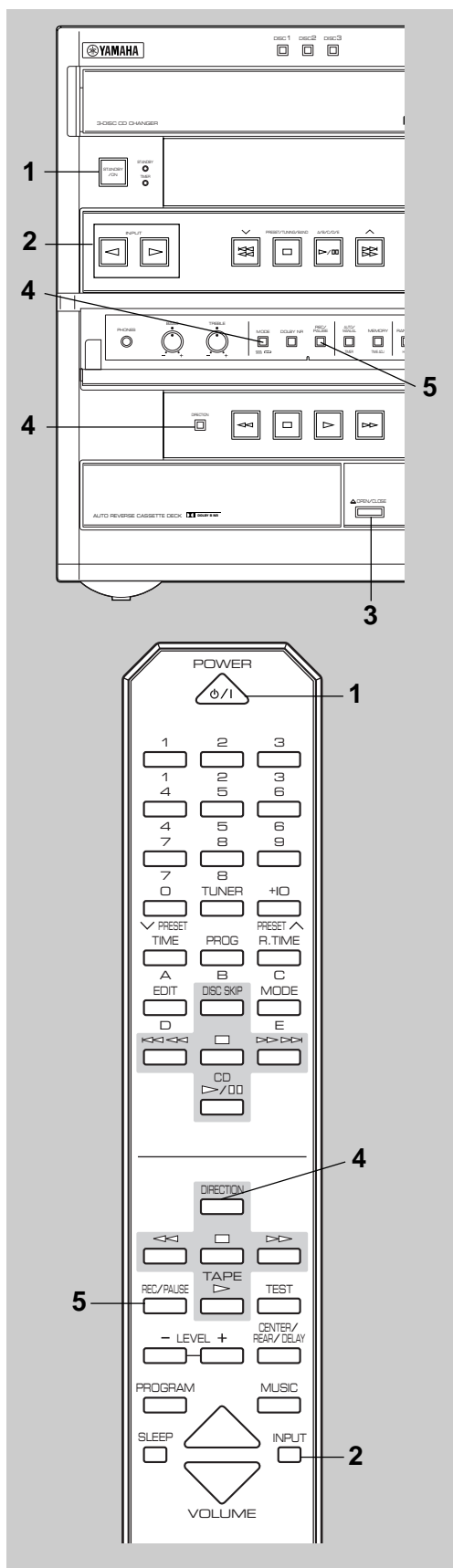

Notes

- Adjusting the **VOLUME**, **BASS** and **TREBLE** controls, and the use of **B. BOOST**, **MUSIC** and **YMERSSION** have no effect on the recorded sound. The recording level is automatically adjusted.
- A sound field program except for **YMERSSION** may have effect on the recorded sound. If a sound field program is selected, cancel it before you begin recording. Refer to page 35 on how to cancel the sound field program.
- If you want to make a recording using Dolby NR, press **DOLBY NR** so that “**NR**” (②) lights up on the display. If not, turn “**NR**” (②) off.
* For details, refer to “Dolby B Type Noise Reduction” on page 23.

Basic recording

- 1 Turn on the power.
- 2 Press **INPUT** \triangleright or \triangleleft repeatedly to select the source you want to record.
- 3 Load a tape on the tray with side A facing upward.
- 4 Press **DIRECTION** or **MODE** to change the current setting, if necessary.

	MODE	
	\rightleftarrows	\rightleftarrows
DIRECTION		
	Side A only	Side A → Side B
	Side B only	Side B only

- 5 Press **REC/PAUSE**.
* “**TAPE REC**” (⑥) lights up on the display.
- 6 Begin playing the source to be recorded and press \triangleright on the tape deck.
When you record from another component that is connected to this system, start the recording on the tape deck first, and then start playing the connected source.
* When playing a CD, the recording automatically begins a few seconds before the disc plays.

Displaying the tape counter

During recording, the information of the playing source is displayed in place of the tape counter (①). Press **DISPLAY** to change the display to the tape counter. Pressing **DISPLAY** again will restore the previous display mode.

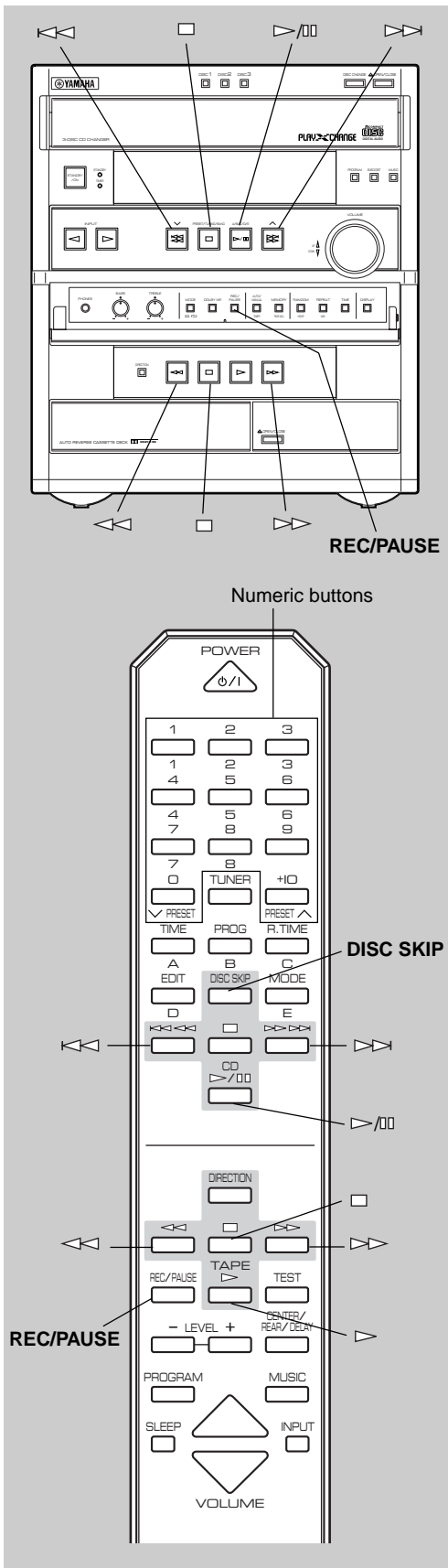

To stop recording temporarily

Press **REC/PAUSE**.

* Press \triangleright on the tape deck to resume recording.

To stop recording

Press \square on the tape deck.

To change the disc and track when recording from a CD

1 Press \square on the CD player.

* The recording stops temporarily.

2 Select the disc by pressing **DISC SKIP** if necessary.

3 Choose the track you want to record next by using \triangleright or \triangleleft .

4 Press \triangleright/\square on the CD player to resume recording (or simply press the corresponding numeric button(s) on the remote control).

Notes

- A sequence of tracks in the program play mode and random play mode of the CD player can be recorded in the same way.
- During recording, you can rewind the tape to the point where the recording started by simply pressing \triangleleft or \triangleright .

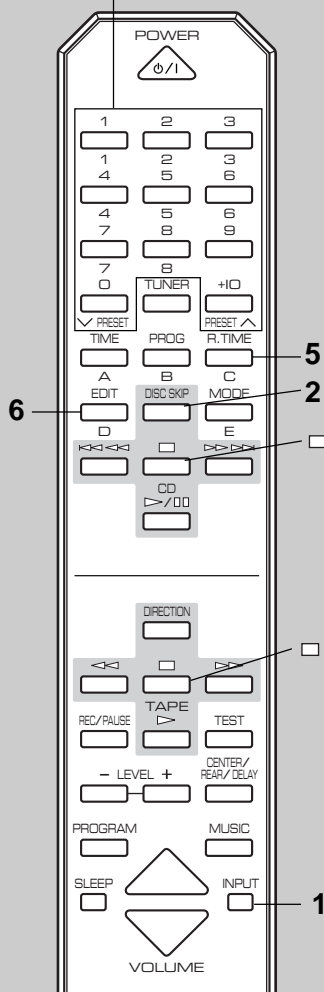
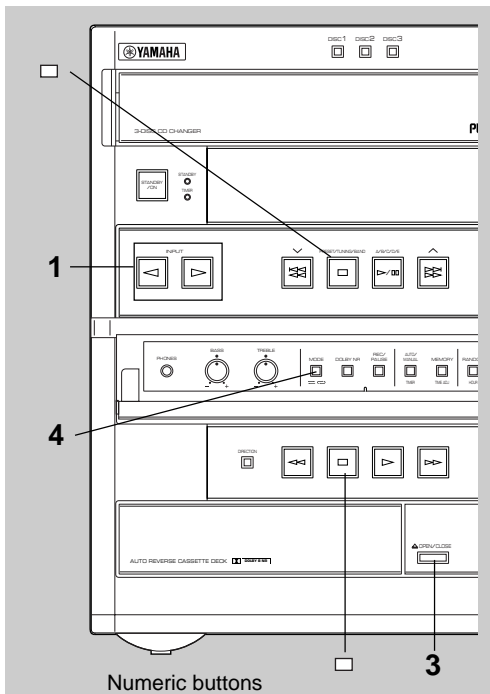

Recording from CDs utilizing the EDIT function

The EDIT function performs recording on both sides of the tape.

■ EDIT recording

- 1 Press **INPUT** \triangleright or \triangleleft repeatedly until "CD" (①) appears on the display, and load the disc to be recorded.
- 2 Select the disc by pressing **DISC SKIP**.
- 3 Load a tape on the tray with side A facing upward.
- 4 Select "↔" (④) by pressing **MODE**.
- 5 Press **R. TIME** on the remote control to select the length of the tape to be used. When pressed, the display changes as shown below.

(off) → C-46 → C-54 → C-60 → C-90

When using tapes other than C-46, C-54, C-60 or C-90

After pressing **R. TIME**, input the tape length by using the numeric buttons on the remote control.

- 6 Press **EDIT**. ("EDIT" (⑧) lights up on the display.)
The following operations are carried out automatically.
 - 1) Tracks on the disc are automatically divided into side A and side B. You can check the process by watching the display.
 - * The tape side indicator (⑨) shows the side currently selected.
 - 2) If the tape is not rewound to the end, it will rewind to the end rapidly.
 - 3) The end part of the tape on which recording cannot be done is automatically wound.
 - 4) Both disc play and recording starts. Recording is continuously carried out on both sides of the tape.

Note

When the CD player is in the all disc play mode, tracks on another disc are recorded continuously if the tape's total possible recording time is longer than the total playing time of the selected disc.

In this case, as many as three discs can be recorded automatically.

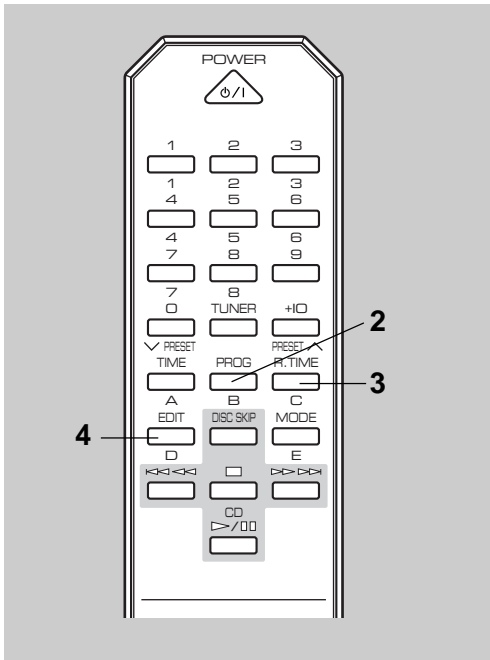

■ Auto-EDIT recording

This recording automatically changes the order of tracks so that the unrecorded space of side A is minimized.

1 Follow steps 1–5 on the previous page.

2 Press **PROG**.

3 Press **R. TIME**.

“Auto A>>>” will light up during programming for side A, and “Auto B>>>” will light up during programming for side B.

4 Press **EDIT**. (“EDIT” (Ⓢ) lights up on the display.)

The recording begins.

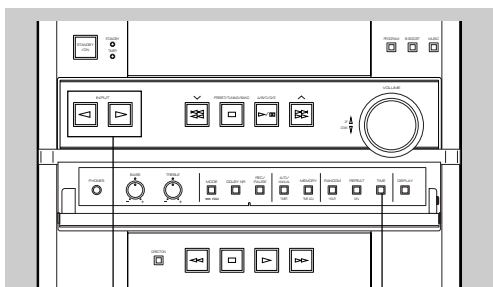

1

TIME

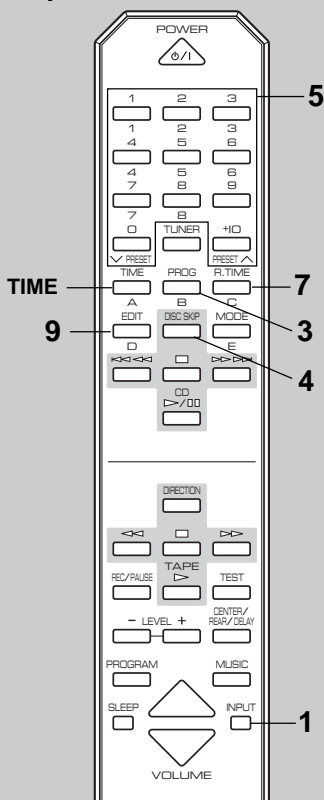

TIME

9

5

7

3

4

1

Manual EDIT recording

You can program tracks manually while watching the remaining time on both sides of the tape.

- 1 Press **INPUT** \triangleright or \triangleleft repeatedly until "CD" (①) appears on the display, and load a disc (or discs) on the disc tray.
- 2 Follow steps 3–5 on page 28.
- 3 Press **PROG**.
 - * "PROG" and "P-01" will light up on the display, and all track numbers on the selected disc will begin blinking.
- 4 If necessary, select the desired disc by pressing **DISC SKIP**.
- 5 Select the desired track number by pressing the numeric buttons.
- 6 Repeat steps 4 and 5 to program more selections for side A of the tape. You can select the same track again.
 - * Pressing **TIME** displays the total remaining time on side A of the tape for about 1 second, and then it is replaced by the display of the next play order.
 - * You can only select track numbers 1 through 15 for manual EDIT recording. All track numbers higher than 15 i.e. 16, 17, 18... cannot be selected for recording even if there is recordable space available on the tape. "TM OVER" will appear on the display.
- 7 When the programming for side A is finished, press **R. TIME**.
 - * "Side-B" appears on the display. You can begin programming for side B.
 - * After following this step, you can check the programmed contents for side A and side B alternately by pressing **R. TIME** at any time before you press **EDIT** in step 9.
 - * The tape side indicator (⑨) shows the programming side currently selected.
- 8 Repeat steps 4 and 5 to program selections for side B of the tape. You can select the same track again.
- 9 Press **EDIT**. ("EDIT" (⑧) lights up on the display.) The recording begins.

Note

To check, cancel or correct program data, refer to page 16.

Display information during programming

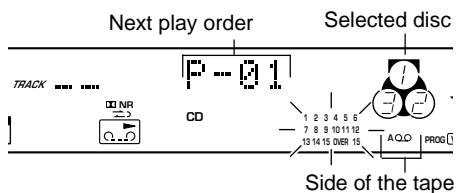

Programmed track numbers light up and only programmable track numbers among unprogrammed ones flash.

To cancel the EDIT function

Before recording, press \square on the CD player or the tape deck.

To stop recording

Press \square on the tape deck.

(At this time, disc play automatically stops.)

Notes on recording with the EDIT function

- The maximum number of tracks that can be programmed is 20.
- The track number 16 or higher cannot be programmed by this function.
- The CD player's repeat play mode will be canceled during the recording mode.

Operating an external unit connected to this system

Use an external unit connected to the VCR, VIDEO or AUX/MD terminals on the rear of the main unit.

■ To listen to or watch a source played on an external unit connected to this system

- 1 Select the input source (VIDEO, VCR or AUX/MD) you want to play by using **INPUT** ▷ or ◁ (or **INPUT** on the remote control).
- 2 Play the source.
 - * If you play a video source, turn on the TV monitor connected to this system.
- 3 Adjust the volume to the desired level by using **VOLUME**.
 - * If you prefer, you can control the sound quality (Refer to pages 32–36).

■ To record a source by using the tape deck, VCR etc. connected to this system

If a tape deck, VCR, etc. is connected to this system, you can record a source played on this system or an external audio/video unit connected to this system by using the tape deck, VCR, etc.

- 1 Select the source you want to record by using **INPUT** ▷ or ◁ (or **INPUT** on the remote control) .
- 2 Play the source and then turn **VOLUME** up to confirm the input source.
- 3 Begin recording on the tape deck, VCR, etc.

Note

A digital-to-digital recording is possible from a CD played on the built-in CD player to an MD (or tape) on the MD recorder (or DAT) by connecting the DIGITAL OUT (OPTICAL) terminal on the rear of the main unit to the MD recorder (or DAT).

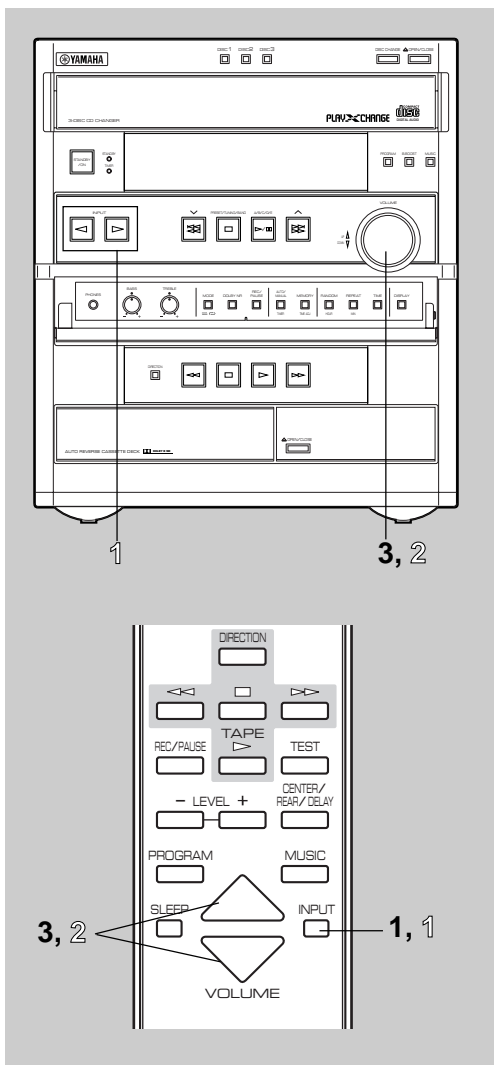

Various sound control

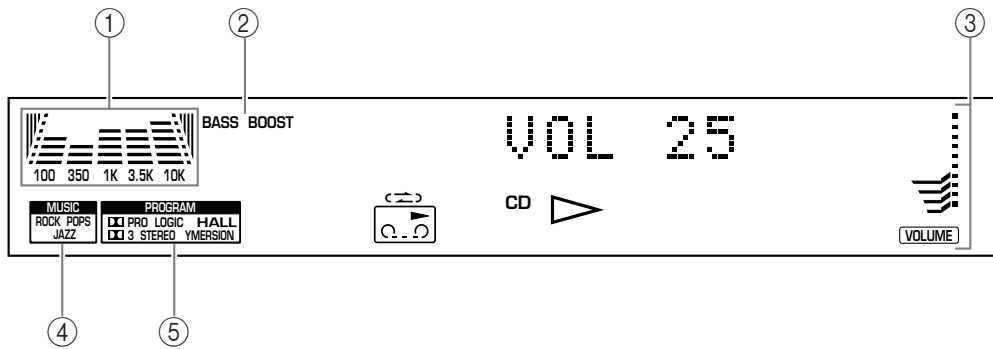

① Spectrum analyzer

The spectrum of the input source which is divided into five bands will be indicated in real time.

② BASS BOOST

③ VOLUME (volume level meter)

④ MUSIC (preset equalizer mode indicator)

⑤ PROGRAM (sound field program indicator)

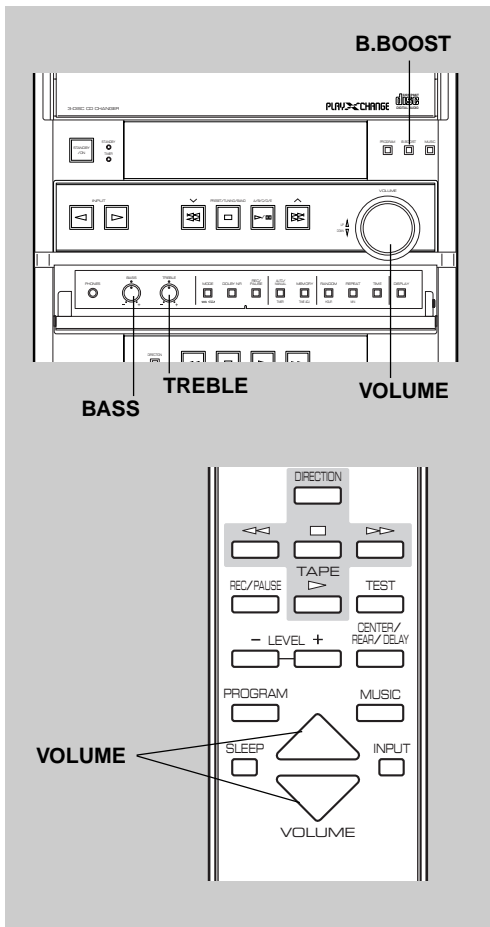

General sound control

■ VOLUME control

Front panel operation

Rotate **VOLUME** in the “UP Δ ” direction to increase the volume, and the “DOWN ∇ ” direction to decrease the volume.

Remote control operation

Press **VOLUME Δ** to increase the volume and **VOLUME ∇** to decrease the volume.

* Adjusted volume level is shown by the volume level meter (③) and in figures on the display.

■ B. (BASS) BOOST button

Press this button so that “BASS BOOST” (②) is illuminated on the display to boost the bass frequency response of this system while maintaining overall tonal balance. This function is effective for reinforcing the bass frequencies when a subwoofer is not used.

■ BASS and TREBLE controls

BASS : Turn this knob clockwise to increase (or counterclockwise to decrease) the low frequency response.

TREBLE : Turn this knob clockwise to increase (or counterclockwise to decrease) the high frequency response.

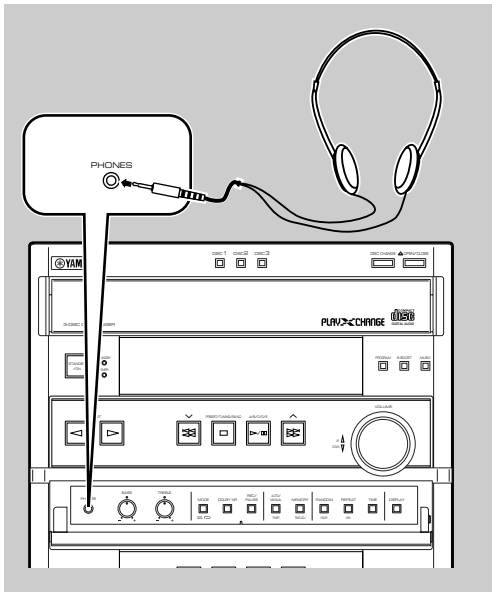

■ Listening with headphones

- Be sure that your headphones have a 3.5 mm (1/8") diameter plug and between 16 ohms and 50 ohms impedance. Recommended impedance is 32 ohms.
- When you listen with headphones, connect the headphones to the **PHONES** jack. You can listen to the sound that is normally outputted from the front speakers through headphones. Adjust **VOLUME** to a comfortable listening level.

Note

When you connect headphones, no signals are outputted to the speakers.

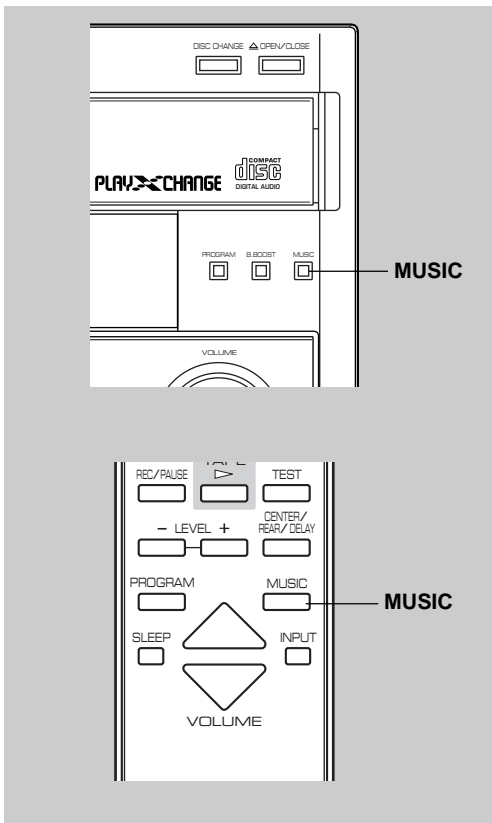

Graphic equalizer

The built-in graphic equalizer provides 3 preset equalizer modes as listed below.

Preset graphic equalizer modes

Mode	Feature
ROCK	High and low frequencies are emphasized. This mode is suitable for reproducing dynamic and powerful sounds of rock music, etc.
POPS	Vocals are emphasized and whole sound is clear. This mode is suitable for pops.
JAZZ	High frequencies for piano, sax, etc. are emphasized. Medium frequencies for vocals are also moderately emphasized.

Listening to the music with a preset equalizer effect

- 1 Play back a source.
- 2 Press **MUSIC** repeatedly until the name of the desired mode lights up on the preset equalizer mode indicator (**MUSIC**) (④).

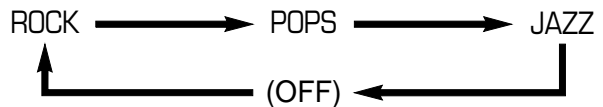



Sound field processor

The Sound Field Processor built into this system enables you to enjoy listening to a source with an ambience of actual concert hall or three-dimensional acoustics. This system provides preset sound field programs shown below. You can enjoy an excellent sound field by selecting any one of them and by adding any other desired adjustments.

This system also incorporates a Dolby Pro Logic Surround decoder for multi-channel sound reproduction of Dolby Surround encoded video sources. The operation of the Dolby Pro Logic Surround decoder can be controlled by selecting a corresponding sound field program.

■ Sound field programs

Program	Feature
 PRO LOGIC	This program is used for playing sources encoded with Dolby Surround. Dolby Pro Logic Surround uses four discrete channels and five speakers to reproduce realistic and dynamic sound effects: two main channels (left and right), a center channel for dialogue, and a rear channel for special sound effects. The rear channel reproduces sound within a narrow frequency range.
 3 STEREO	This program is used for simplified play of Dolby Surround encoded sources. With this program, sound effects are outputted from the front left and right speakers and no sound from the rear speakers.
YMERSION	YMERSION is Yamaha's proprietary technology that enhances the spread of a normal stereo source play sound, creating three-dimensional acoustics using only two speakers.
HALL	This program presents you with an ambience of actual concert hall by adding effects as sonic reflections or reberverations that create sound environment of a hall. Sound effects are outputted from the front and rear speakers. Orchestra and opera music is suited for this sound field.



Manufactured under license from Dolby Laboratories. "Dolby", "Pro Logic" and the double-D symbol are trademarks of Dolby Laboratories. Confidential Unpublished Works. ©1992–1997 Dolby Laboratories, Inc. All rights reserved.

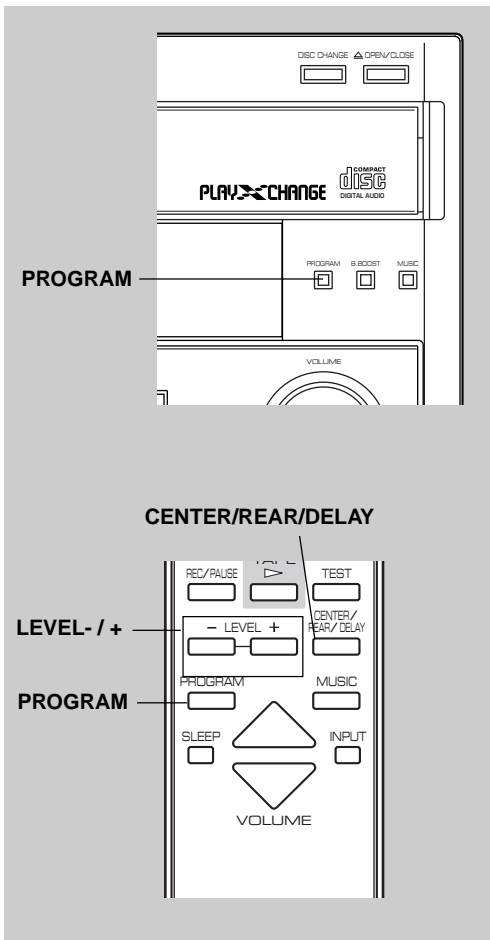

■ Listening to the music with a sound field effect

- 1 Play a source.
- 2 Press **PROGRAM** repeatedly until the name of the desired program lights up on the sound field program indicator (⑤).
* Whenever you press **PROGRAM**, the program changes and is displayed as follows.

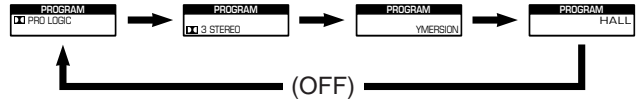

- 3 If desired, adjust the delay time and the output level of each speaker. (For details, refer to the corresponding descriptions on pages 35–36.)

Notes

- When YMERSION is selected, no sound is heard from the center speaker nor rear speakers.
- If you play a source not encoded with Dolby Surround when PRO LOGIC is selected, the source may not be played normally.

■ Adjusting delay time and speaker output level

DELAY TIME

You can adjust the time difference between the beginning of the sound from the front speakers and the beginning of the effect sound from the rear speakers.

The larger the value, the later the effect sound is generated. This adjustment can be made individually for both PRO LOGIC and HALL.

Control range

- PRO LOGIC: 15, 20, 25, 30 milliseconds
- HALL: 15, 20, 25, 30, 40, 50 milliseconds

- 1 Press **CENTER/REAR/DELAY** repeatedly until “DELAY” appears on the display.
- 2 By pressing **LEVEL +** or **-** continuously, the value also changes continuously.



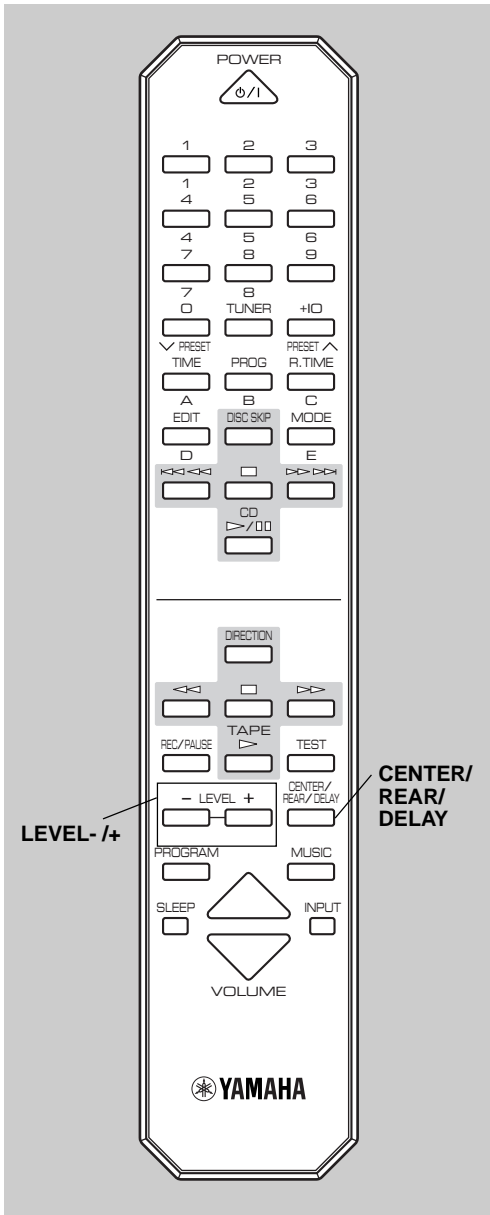

If desired, you can adjust the sound output level of the center and/or rear speakers even if the output level is already set in “Speaker balance adjustment” on page 11.

CENTER LEVEL

Control range : +10 to -21

- 1 Press **CENTER/REAR/DELAY** repeatedly until “CENTER” appears on the display.
- 2 By pressing **LEVEL +** or **-** continuously, the level value also changes continuously.

CENTER +10
Changes.

Notes

- This adjustment can be made only when the sound field program PRO LOGIC or 3 STEREO is selected.
- Once the output level is adjusted, the level value will be the same for both the PRO LOGIC and 3 STEREO programs.

REAR LEVEL

Control range : +10 to -21

- 1 Press **CENTER/REAR/DELAY** repeatedly until “REAR” appears on the display.
- 2 By pressing **LEVEL +** or **-** continuously, the level value also changes continuously.

REAR +10
Changes.

Notes

- This adjustment can be made only when a sound field program PRO LOGIC or HALL is selected.
- Adjustment can be made individually for both PRO LOGIC and HALL.

Using the built-in timer

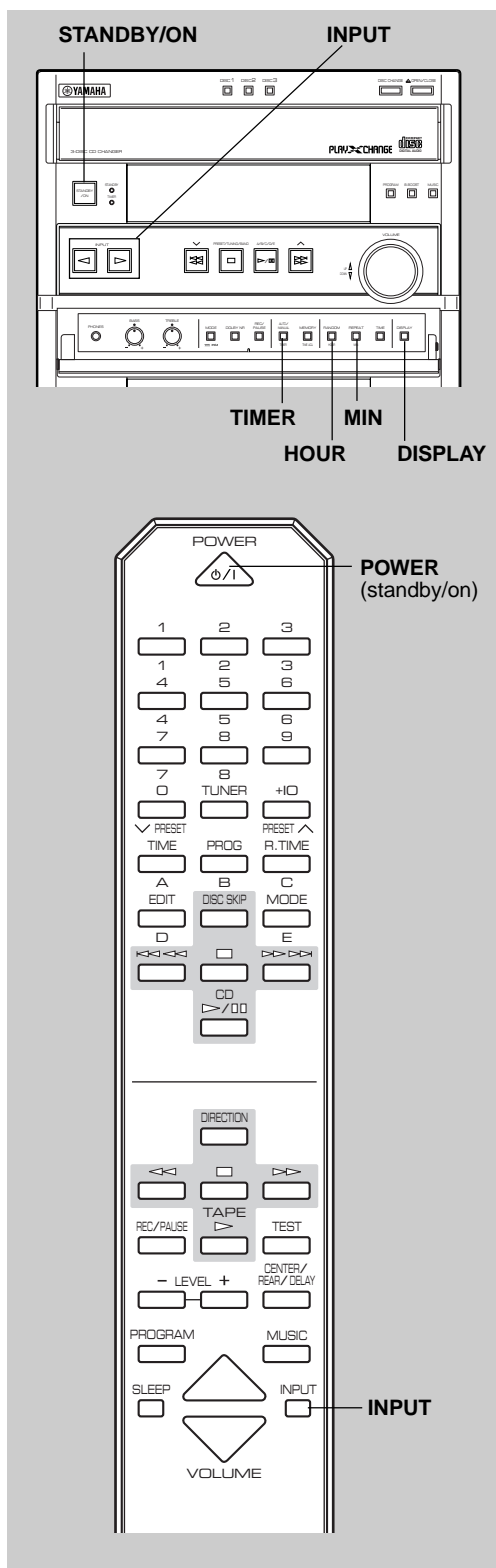

Timer play

By using the built-in timer, you can set the time when this system turns on and a source play begins, and the time when this system is set to the standby mode.

1 Press **DISPLAY**.

Whenever **DISPLAY** is pressed, the display mode changes as follows.

- 1 Current time (TIMER on/off mode)
- ↓
- 2 Source selecting mode (TAPE, TUNER, CD)
- ↓
- 3 ON TIME/Time setting mode
- ↓
- 4 OFF TIME/Time setting mode
- ↓
- 5 Normal display mode

Note

The display mode will change in about 8 seconds. If the mode is changed before the setting is completed, call the mode again by pressing **DISPLAY** once or more.

1 Current time

Make sure that the current time is correct, and press **TIMER** so that "TIMER" lights up on the display.

2 Source selecting mode

Select the source to be played with **INPUT** \triangleright or \triangleleft (or **INPUT** on the remote control).

3 ON TIME/time setting mode

["ON TIME" appears on the display, and soon it is changed to a time setting mode.]

Set the time when you want to begin the timer play.

- Press **HOUR** and set the hour.
- Press **MIN** and set the minute.

4 OFF TIME/time setting mode

If necessary, set the time when you want to finish the timer play in the same way as you did in step [3]. If you do not set the time, it will be automatically set so that the timer play finishes after 1 hour.

2 Press **TIMER** to complete the timer play setting.

This system turns into the standby mode.

* The **STANDBY** and **TIMER** indicators light up.

If you will continue using this system, press **STANDBY/ON** to turn on this system.

To cancel the timer play setting

Press **DISPLAY**, and then press **TIMER** so that the **TIMER** indicator goes out.

Note

Unless there is a power failure for more than 5 minutes, the set time will be retained until it is reset.

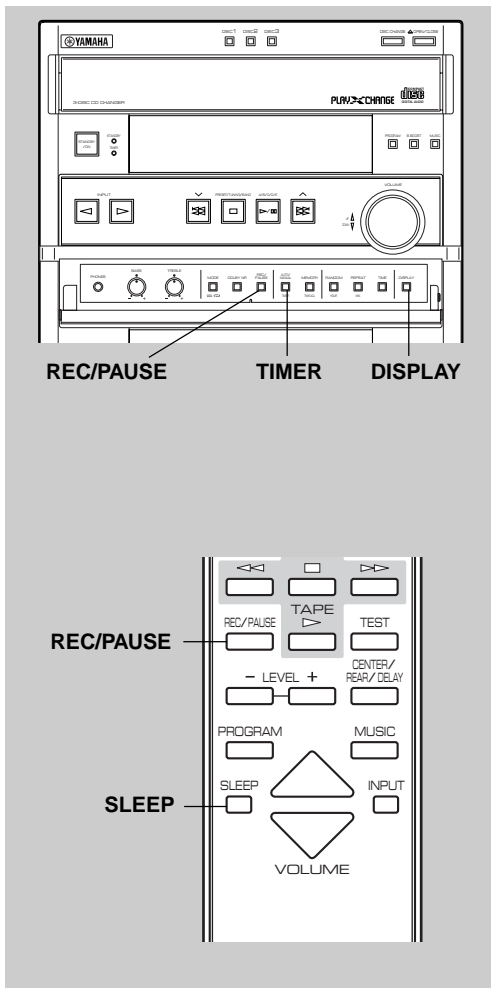

Timer recording

- 1 Follow steps 2–3 of “Basic recording” on page 26.
- 2 Tune in to the station you want to record.
- 3 Follow step 1 of “Timer play” on page 37.
 - * In step 2, select “TUNER”, and then press **REC/PAUSE**. (“REC >TAPE” and the frequency will flash alternately on the display.)
 - * In step 3, set the time when you want to begin recording.
 - * In step 4, set the time when you want to finish recording.
- 4 Press **TIMER**.
 - This system will be set to the standby mode.
 - * The **STANDBY** and **TIMER** indicators light up.

To cancel the setting of timer recording

Press **DISPLAY** once or more so that “REC >TAPE” flashes on the display. While “REC >TAPE” is flashing, press **REC/PAUSE**.

Note

When the timer recording is finished, the timer setting is automatically canceled.

Sleep timer operation

This system will automatically be set to the standby mode when the selected sleep time passes.

- 1 Play the desired sound source.
- 2 Press **SLEEP** repeatedly until the desired sleep time appears on the display. The display will change as described below.

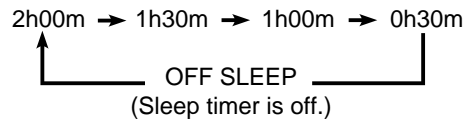

- * The normal display mode will resume about 4 seconds after the selection is made.
- * “SLEEP” will light up on the display.

Troubleshooting

Refer to the chart below when this system does not function properly. If the problem you are experiencing is not listed below or if the instruction below does not help, disconnect the supply lead and contact your authorized YAMAHA dealer or service center.

	Problem	Cause	What to Do
General	This system does not work normally.	There is an influence of strong external noise (lightning, excessive static electricity, etc.) or the system was operated incorrectly.	Set this system to the standby mode and disconnect the AC supply lead from the AC outlet. After about 30 seconds, connect the power and operate this system again.
	The sound suddenly goes off.	The protection circuit was activated because of a short circuit, etc.	Set this system to the standby mode, then turn on to reset the protection circuit.
		The SLEEP timer was activated.	Cancel the SLEEP timer function.
	No sound from speakers.	Speaker connections are not secure.	Secure the connections.
	No sound from the rear speakers.	The sound output level to the rear speakers is set to minimum.	Raise the sound output level to the rear speakers.
		Incorrect sound field program selection. No sound field program is selected.	Select the appropriate program.
	No sound from the center speaker.	The sound output level to the center speaker is set to minimum.	Raise the sound output level to the center speaker.
		Incorrect sound field program selection. No sound field program is selected.	Select the appropriate program.
	No sound (or no picture) from the external unit connected to this system.	Incorrect cord connections.	Connect the cords properly. If the problem persists, the cords may be defective.
		Input source selection is not correct.	Make a correct input source selection.
Timer cannot be set.	Current time is not set.	Set current time.	
This system will not operate properly.	The internal microcomputer has been frozen by an external electric shock (lightning, excessive static electricity, etc.) or power supply with low voltage.	Unplug the AC supply lead from the wall AC outlet, then plug in again after about one minute.	
The volume level cannot be increased, or sound is distorted.	The component connected to the AUX/MD or VCR terminals on the rear of the main unit is turned off.	Turn on the power to the component.	
A picture of the TV is disturbed.	There is an influence of magnet from the center speaker.	Place the center speaker apart from the TV.	
Tuner	Excessive static in FM broadcasts.	Interference from starting motor of nearby car.	Position the FM antenna as high and as far away from nearby roads as possible. Use coaxial cable.
		Interference from thermostat of nearby electric appliance.	
	Noise increases during stereo broadcasts.	Antenna input is too weak due to obstructions or excessive distance from broadcasting station.	Check antenna connections. Install a multi-element type FM antenna if possible.
	Stereo broadcasts are noisy and STEREO indicator blinks on and off.	Insufficient antenna input.	Install an antenna suited for the electric field strength of your area.
	Preset stations cannot be selected.	Preset memory has been erased.	Reprogram memory presettings.
	Buzzing or static during AM broadcasts.	Interference from sources such as lightning, fluorescent lights, electric motors or thermostat of nearby electric appliance.	Problem is difficult to eliminate but can be lessened by grounding AM loop antenna.
		TV or this system is being used nearby.	Move away from TV or this system.
AM broadcast sensitivity is poor.	Radio signal is weak or antenna is not properly connected.	Properly connect AM loop antenna.	
		Change orientation of AM loop antenna.	
		Install an external AM antenna.	

Appendix

	Problem	Cause	What to Do
CD player	A disc cannot be played normally, or there is a noise during play.	The disc is not a standard type.	Play another disc.
	Play will not begin even if disc is loaded.	Disc is upside down.	Load disc with label side facing upward.
		Disc is dirty.	Clean disc.
	No sound.	The input source selection is incorrect.	Select the CD player by pressing INPUT ◀ or ▶ button until "CD" lights up on the display.
Sound stops suddenly (always at the same spot).	Disc is dirty.	Clean disc.	
	Volume is set too high.	Lower volume.	
Tape deck	Tape will not move during playback or recording.	Slack tape wrapped around pinch roller.	Tighten slack with a pencil (pen) before using.
	Recording is not possible.	Erasure prevention tab is broken off.	Replace tape or cover erasure prevention hole with adhesive tape.
		Head is dirty.	Clean heads.
	Sound is distorted or fades out, or stereo balance is poor.	Head is dirty.	Clean heads.
		Tape is worn.	Replace tape.
	Poor sound quality.	Tape encoded with Dolby NR is played back with this system's Dolby NR off.	Press the DOLBY NR button to turn it on.
		Tape not encoded with Dolby NR is played back with this system's Dolby NR on.	Press the DOLBY NR button to turn it off.
	Excessive noise.	Head has become magnetized.	Demagnetize heads with head demagnetizer.
	Tape travel stops in middle of playback or recording.	Slack tape coming out of cassette shell.	Tighten slack with a pencil (pen) before using.
		Tape is creased or torn.	Replace tape.
Endless tape is being used.		Do not use endless tapes.	
The beginning of desired selections on tape cannot be found.	Silent gaps between selections are too short.	The function of searching for the beginning of desired selections will not operate unless the silent gaps between selections are at least four seconds long.	
	Excessively soft passages in middle of selections.		
	Conversation, etc. is recorded.		
Beginning of the track isn't recorded.	There is an unrecordable part in the first few seconds of the tape.	Wind the unrecordable part of the tape and start recording from the recordable part.	
Remote control	Remote control does not work.	Batteries are dead.	Replace batteries.
		Remote control is too far away or tilted too much.	Use within 6 m and 60° radius.
		Direct sunlight or lighting (of an inverter type fluorescent lamp, etc.) is striking the remote control sensor of the main unit.	Reposition the main unit.
	TV functions strangely when the remote control is used.	Remote control is being used near TV set with a remote control sensor.	Relocate the main unit away from the TV.

Specifications

■ Amplifier section

Minimum RMS Output Power per Channel	
FRONT	
6 ohm, 1 kHz, 0.9% THD	80W+80W
6 ohm, 1 kHz, 10% THD	100W+100W
CENTER	
6 ohm, 1 kHz, 0.9% THD	80W
6 ohm, 1 kHz, 10% THD	100W
REAR	
6 ohm, 1 kHz, 0.9% THD	25W
6 ohm, 1 kHz, 10% THD	30W
Input Sensitivity/Impedance	
AUX/MD	200 mV/47 k-ohm
Spectrum Analyzer Band	
(100 Hz, 350 Hz, 1 kHz, 3.5 kHz, 10 kHz)	

■ Video section

Video Signal Level	1 Vp-p/75 ohm
--------------------------	---------------

■ Tuner section

Tuning Range	
FM	
[U.S.A. and Canada models]	87.5 to 107.9 MHz
[Australia model]	87.5 to 108.0 MHz
AM	
[U.S.A. and Canada models]	530 to 1,710 kHz
[Australia model]	531 to 1,611 kHz
Usable Sensitivity (FM)	
DIN, Mono, S/N 26 dB	1.8 μ V
S/N 30 dB, 1 kHz, 100% Mod.	1.5 μ V

■ CD player section

Discs Supported	Audio CD
Type	3 disc carousel auto-changer
D/A Converter	1-bit DAC
Filter	8-time oversampling digital filter

■ Tape deck section

Type	Auto reverse stereo cassette deck
Frequency Response (-20 dB)	
Type 1 (Normal)	50 to 15,000 Hz
Type 2 (High)	50 to 16,000 Hz
Wow and Flutter	0.09%, W.RMS
Signal-to-Noise Ratio	
58 dB (Dolby NR OFF)	
66 dB (Dolby B NR ON)	
Harmonic Distortion	0.8%

■ Speaker section

Type (Magnetic shielding type)	
Front speaker	3-way bass reflex: 13 cm (5") woofer 5 cm (2") tweeter 2 cm (3/4") super tweeter
Center speaker	8 (3") cm full range x 2
Rear speaker	8 (3") cm full range
Maximum input	
Front, Center, Rear	220W, 180W, 100W
Impedance	
Front, Center	6 ohm
Rear	12 ohm

■ General

Power Supply	
[U.S.A. and Canada models]	AC 120V, 60 Hz
[Australia model]	AC 240V, 50 Hz
Power consumption	170W
Dimensions (W x H x D)	
Main unit	280 x 320 x 364 mm (11" x 12-5/8" x 14-5/16")
Front Speaker	200 x 320 x 208 mm (7-7/8" x 12-5/8" x 8-3/16")
Center Speaker	280 x 100 x 188 mm (11" x 3-15/16" x 7-3/8")
Rear Speaker	94 x 117 x 108 mm (3-11/16" x 4-5/8" x 4-1/4")
Weight	
Main unit	10.5 kg (23 lbs. 2 oz.)
Front Speaker	3.8 kg (8 lbs. 6 oz.) x 2
Center Speaker	2.0 kg (4 lbs. 6 oz.)
Rear Speaker	0.7 kg (1 lbs. 9 oz.) x 2
Accessories	
Remote control	
Batteries	
Speaker cords	
AM loop antenna	
Indoor FM antenna	
Mounting brackets	
Screws	
Velcro strips	

Specifications are subject to change without notice.



YAMAHA ELECTRONICS CORPORATION, USA 6660 ORANGETHORPE AVE., BUENA PARK, CALIF. 90620, U.S.A.
YAMAHA CANADA MUSIC LTD. 135 MILNER AVE., SCARBOROUGH, ONTARIO M1S 3R1, CANADA
YAMAHA ELECTRONIK EUROPA G.m.b.H. SIEMENSSTR. 22-34, 25462 RELLINGEN BEI HAMBURG, FR. OF GERMANY
YAMAHA ELECTRONIQUE FRANCE S.A. RUE AMBROISE CROIZAT BP70 CROISSY-BEAUBOURG 77312 MARNE-LA-VALLEE CEDEX02, FRANCE
YAMAHA ELECTRONICS (UK) LTD. YAMAHA HOUSE, 200 RICKMANSWORTH ROAD WATFORD, HERTS WD1 7JS, ENGLAND
YAMAHA SCANDINAVIA A.B. J A WETTERGRENS GATA 1, BOX 30053, 400 43 VÄSTRA FRÖLUNDA, SWEDEN
YAMAHA MUSIC AUSTRALIA PTY, LTD. 17-33 MARKET ST., SOUTH MELBOURNE, 3205 VIC., AUSTRALIA

YAMAHA CORPORATION
Printed in Malaysia **UP** VIDEO V558820