

YAMAHA

KPA-502

DIGITAL KARAOKE PROCESSING AMPLIFIER AMPLIFICATEUR KARAOKE / D.S.P.

OWNER'S MANUAL

CONTENTS

CAUTION	3
FEATURES	4
ACCESSORY	4
CONNECTIONS	5
CONTROLS AND THEIR FUNCTIONS	7
BASIC OPERATION	8
VARIOUS FUNCTIONS FOR KARAOKE PLAY	10
REMOTE CONTROL TRANSMITTER	11
TROUBLESHOOTING	12
SPECIFICATIONS	12

Thank you for purchasing this unit.
To make full and effective use of this unit, please read this Owner's Manual carefully before operating the unit.
After reading, retain this booklet for future reference.

MODE D'EMPLOI

TABLE DES MATIERES

ATTENTION	13
PARTICULARITES	14
ACCESSOIRES	14
RACCORDEMENTS	15
LES COMMANDES ET LEURS FONCTIONS	17
OPERATIONS DE BASE	18
FONCTIONS DIVERSES POUR L'UTILISATION EN KARAOKE	20
BOITIER DE TELECOMMANDE	21
DETECTION DE PANNES	22
CARACTERISTIQUES	22

Merci pour avoir acheté cet appareil.
Afin de pouvoir utiliser complètement et efficacement cet appareil, lire ce mode d'emploi attentivement avant de faire fonctionner l'appareil.
Après avoir l'avoir lu, conserver ce mode d'emploi comme référence future.

SAFETY INSTRUCTIONS



• Explanation of Graphical Symbols



The lightning flash with arrowhead symbol, within an equilateral triangle, is intended to alert you to the presence of uninsulated "dangerous voltage" within the product's enclosure that may be of sufficient magnitude to constitute a risk of electric shock to persons.



The exclamation point within an equilateral triangle is intended to alert you to the presence of important operating and maintenance (servicing) instructions in the literature accompanying the appliance.

WARNING

TO REDUCE THE RISK OF FIRE OR ELECTRIC SHOCK, DO NOT EXPOSE THIS APPLIANCE TO RAIN OR MOISTURE.

- 1** Read Instructions — All the safety and operating instructions should be read before the unit is operated.
- 2** Retain Instructions — The safety and operating instructions should be retained for future reference.
- 3** Heed Warnings — All warnings on the unit and in the operating instructions should be adhered to.
- 4** Follow Instructions — All operating and other instructions should be followed.
- 5** Water and Moisture — The unit should not be used near water — for example, near a bathtub, washbowl, kitchen sink, laundry tub, in a wet basement, or near swimming pool, etc.
- 6** Carts and Stands — The unit should be used only with a cart or stand that is recommended by the manufacturer.
- 6A** A unit and cart combination should be moved with care. Quick stops, excessive force, and uneven surfaces may cause the unit and cart combination to overturn.



7 Wall or Ceiling Mounting — The unit should be mounted to a wall or ceiling only as recommended by the manufacturer.

8 Ventilation — The unit should be situated so that its location or position does not interfere with its proper ventilation. For example, the unit should not be situated on a bed, sofa, rug or similar surfaces that may block the ventilation openings; or placed in a built-in installation, such as a bookcase or cabinet that may impede the flow of air through the ventilation openings.

9 Heat — The unit should be situated away from heat sources such as radiators, stoves, or other units that produce heat.

10 Power Sources — The unit should be connected to a power supply only of the type described in the operating instructions or as marked on the unit.

11 Power-Cord Protection — Power-supply cords should be routed so that they are not likely to be walked on or pinched by items placed upon or against them, paying attention to receptacles, and the point where they exit from the unit.

12 Cleaning — The unit should be cleaned only as recommended by the manufacturer.

13 No Use Periods — The power cord of the unit should be unplugged from the outlet when left unused for a long period of time.

14 Object and Liquid Entry — Care should be taken so that objects do not fall into and liquids not spilled into the inside of the unit.

15 Damage Requiring Service — The unit should be serviced by qualified service personnel when:

- A.** The power-supply cord or the plug has been damaged; or
- B.** Objects have fallen, or liquid has been spilled into the unit; or
- C.** The unit has been exposed to rain; or
- D.** The unit does not appear to operate normally or exhibits a marked change in performance; or
- E.** The unit has been dropped, or the cabinet damaged.

16 Servicing — The user should not attempt to service the unit beyond those means described in the operating instructions. All other servicing should be referred to qualified service personnel.

17 Power Lines — An outdoor antenna should be located away from power lines.

18 Grounding or Polarization — The precautions should be taken so that the grounding or polarization of the unit is not defeated.

IMPORTANT!

Please record the serial number of this unit in the space below.

Model:
Serial No.:

The serial number is located on the rear of the unit. Retain this Owner's Manual in a safe place for future reference.

FCC INFORMATION (U.S.A.)

1. IMPORTANT NOTICE: DO NOT MODIFY THIS UNIT!

This product, when installed as indicated in the instructions contained in this manual, meets FCC requirements. Modifications not expressly approved by Yamaha may void your authority, granted by the FCC, to use the product.

2. IMPORTANT: When connecting this product to accessories and/or another product use only high quality shielded cables. Cables supplied with this product MUST be used. Follow all installation instructions. Failure to follow instructions could void your FCC authorization to use this product in the USA.

3. NOTE: This product has been tested and found to comply with the requirements listed in FCC Regulations, Part 15 for Class "B" digital devices. Compliance with these requirements provides a reasonable level of assurance that your use of this product in a residential environment will not result in harmful interference with other electronic devices. This equipment generates/uses radio frequencies and, if not installed and used according to the instructions found in the users manual, may cause interference harmful to the operation of other electronic devices. Compliance with FCC regulations does not guarantee that interference will not occur in all installations. If this product is found to be the source of interference, which can be determined by turning the unit "OFF" and "ON", please try to eliminate the problem by using one of the following measures:

Relocate either this product or the device that is being affected by the interference.

Utilize power outlets that are on different branch (circuit breaker or fuse) circuits or install AC line filter/s.

In the case of radio or TV interference, relocate/reorient the antenna. If the antenna lead-in is 300 ohm ribbon lead, change the lead-in to coaxial type cable.

If these corrective measures do not produce satisfactory results, please contact your local retailer that is authorized to distribute this type of product. If you cannot locate the appropriate retailer, please contact Yamaha Electronics Corp., U.S.A.
6660 Orangethorpe Ave, Buena Park, CA 90620

The above statements apply ONLY to those products distributed by Yamaha Corporation of America or its subsidiaries.

CAUTION: READ THIS BEFORE OPERATING YOUR UNIT.

1. This unit is a sophisticated stereo amplifier. To ensure proper operation for the best possible performance, please read this manual carefully.
2. Choose the installation location of your unit carefully. Avoid placing it in direct sunlight or close to source of heat. Also avoid locations subject to vibration and excessive dust, heat, cold or moisture. Keep it away from sources of hum such as transformers or motors.
3. Do not open the cabinet as this may result in damage to the unit or electrical shock. If a foreign object should get into the unit, contact your local dealer.
4. When removing the power plug from the wall outlet, always pull directly on the plug; never pull the cord itself.
5. Do not apply excessive force when operating switches and knobs.
6. When moving the unit, be sure to first pull out the power plug and remove all cords connecting the unit to other equipment.
7. Do not attempt to clean this unit with chemical solvents as this may damage the finish. Use a clean, dry cloth.
8. Always set the VOLUME control to "∞" before playing the source. Increase the volume gradually to a desired level after the source has started playing.
9. When not planning to use this unit for long periods of time (e.g., vacation, etc.), disconnect the AC power plug from the electrical outlet.
10. Do not connect audio equipment to the AC outlet on the rear panel if the equipment requires more power than the outlet is rated to provide.
11. The openings on the cabinet assure proper ventilation of the unit. If these openings are obstructed, the temperature inside the cabinet will rise rapidly, damaging the unit or causing a fire. Avoid blocking the ventilation openings and make sure that the unit is well ventilated. Allow at least 5 cm (2 in) of space above and behind the unit and at least 3 cm (1-1/4 in) of space to the left and right of the unit.
12. Be sure to read the "TROUBLESHOOTING" section of this manual for advice on common operating errors before concluding that your unit is faulty.
13. Keep this manual in a safe place for future reference.
14. **Voltage Selector (General and China model only)**
The voltage selector on the rear panel of this unit must be set for your local mains voltage BEFORE plugging in the AC mains supply. (Voltage selector adjustable between 110/120/220/240 V AC 50/60 Hz)

We Want You Listening For A Lifetime

YAMAHA and the Electronic Industries Association's Consumer Electronics Group want you to get the most out of your equipment by playing it at a safe level. One that lets the sound come through loud and clear without annoying blaring or distortion – and, most importantly, without affecting your sensitive hearing.

Since hearing damage from loud sounds is often undetectable until it is too late, YAMAHA and the Electronic Industries Association's Consumer Electronics Group recommend you avoid prolonged exposure to excessive volume levels.



FOR CANADIAN CUSTOMERS

TO PREVENT ELECTRIC SHOCK, MATCH WIDE BLADE OF PLUG TO WIDE SLOT AND FULLY INSERT.

THIS CLASS B DIGITAL APPARATUS MEETS ALL REQUIREMENTS OF THE CANADIAN INTERFERENCE-CAUSING EQUIPMENT REGULATIONS.

FEATURES

- Three audio inputs (VCD/LD, TAPE and AUX), two video inputs (VCD/LD and AUX) and two video outputs (MONITOR OUT 1 and 2) allow you to connect various audio/video components.
- Combination of three different Echo controls (VOLUME, REPEAT, DELAY) gives various echo effects to voices through the microphones.
- Digital Key Control function allows you to select the desired musical pitch. (± 2 note, 9 steps)
- With Sound Multiplex sources, the volume of the original vocals and the music can be adjusted by using the MPX BALANCE control.
- MUSIC VOL control lets you balance your vocals and the music by adjusting the music volume level.
- VOCAL AID replaces the original vocals with your voice when you sing.
- The built in KARAOKE DSS sound field processor has four different settings (BALLAD, POPS, JAZZ, and ROCK) to let you obtain the desired atmosphere according to the music type.
- ONE TOUCH KARAOKE lets you cut the original vocals from general stereo sources so they can be used as karaoke sources.
- Your karaoke play can be recorded with a cassette deck connected to this unit.
- High-power built-in amplifier

What are the Sound multiplex sources?

With a Sound Multiplex tape designed for karaoke use or a sound multiplex disc (laser karaoke disc, etc.), generally, the right channel contains both background music and original vocals, and the left channel contains only background music.

Thus, these sources allow you to select only the background music, or to adjust the volume between original vocals and music by rotating the MPX BALANCE control.

Note:

There are also other types of karaoke sources, with which the sound adjustments of this unit may not function properly. Please confirm the type is the karaoke source you have purchased, before reproducing it with this unit.

ACCESSORY

After unpacking, check that the following accessories are supplied.

Remote control transmitter

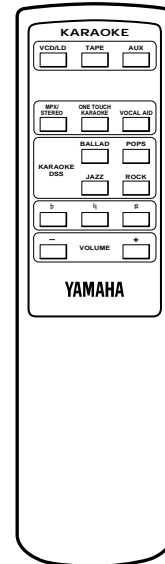

Batteries (size AA, R6, UM-3)

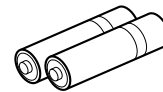

CONNECTIONS

- Be sure to disconnect power cords of all the audio and video components from the AC outlets. Do not turn the power on until all connections are completed.
- When making connections between this unit and other components, make sure that all connections are correct, L (left) to L, R (right) to R.

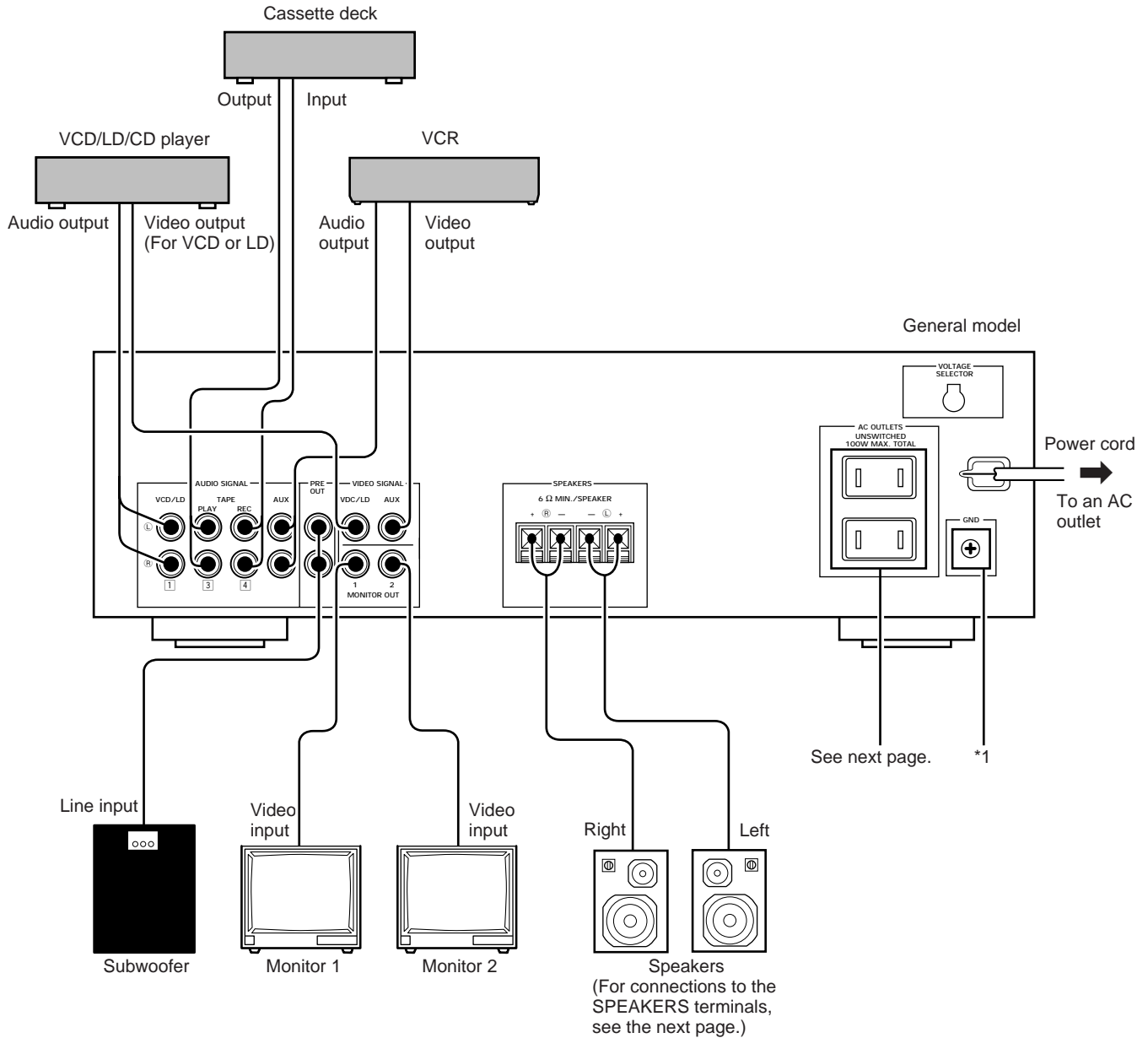

For powerful sound

To reproduce a more powerful sound, connect a power amplifier (instead of a subwoofer) to the PRE OUT jacks to drive high-power speakers.

*1 GND terminal

Usually, it is not necessary to make a connection to this terminal. However, when excessive noise exists, connect the GND terminals of this unit and other components to minimize the noise.

Connecting speakers

Connect the SPEAKERS terminals to your speakers with wire of the proper gauge cut as short as possible. If the connections are faulty, no sound will be heard from the speakers. Make sure that the polarity (+ and - markings) of the speaker wires are correct. If these wires are reversed, the sound will be unnatural and will lack bass. Do not let bare speaker wires touch each other and do not let them touch the metal parts of this unit as this could damage this unit and/or speakers.

- **Use speakers with an impedance of 6 ohms or more. Using speakers with an impedance of less than 6 ohms may result in malfunction or damage to this amplifier.**
- **Do not connect more than one pair in parallel to this amplifier.**

- ① Press down the tab.
- ② Insert the bare wire. [Remove approx. 5mm insulation from the speaker wires.]
- ③ Raise the tab to secure the wire.

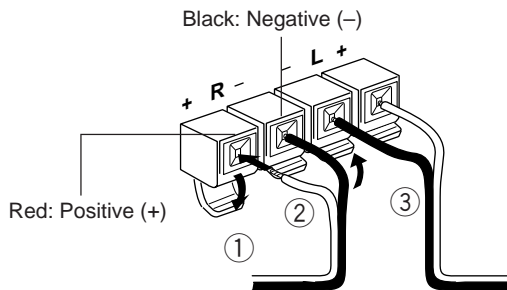

Connecting the AC OUTLETS

This unit is equipped with two UNSWITCHED AC OUTLETS for connecting the power cords of other components to this unit.

The power to these outlets is not controlled with this unit's POWER switch. They will continuously supply power to any component connected to them.

The total maximum power consumption of components connected to these outlets must not exceed 100 watts.

CONTROLS AND THEIR FUNCTIONS

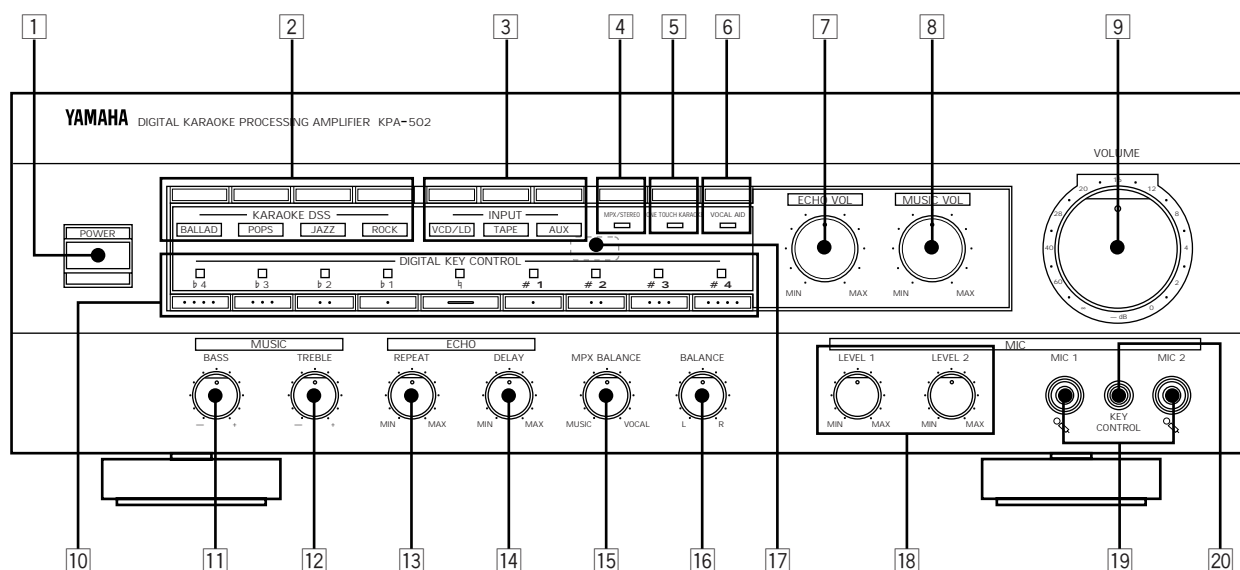

- 1 **POWER button**
Press this button to turn the power on or off.
- 2 **KARAOKE DSS buttons / indicators (BALLAD, POPS, JAZZ, ROCK)**
Press one of these buttons to obtain a suitable effect for the corresponding music type.
- 3 **INPUT selector (VCD/LD, TAPE, AUX)**
Press one of these buttons to select the input signal.
- 4 **MPX/STEREO button / indicator**
Press this button when playing the sound multiplex karaoke disc or tape.
- 5 **ONE TOUCH KARAOKE button / indicator**
Press this button to reduce the level of the original vocals when playing a stereo source.
- 6 **VOCAL AID button / indicator**
Press this button to replace original vocals with your voice when singing a karaoke song.
- 7 **ECHO VOL control**
Adjusts the echo level.
- 8 **MUSIC VOL control**
Adjusts the music volume.
- 9 **VOLUME control**
Adjusts the volume.
- 10 **DIGITAL KEY CONTROL buttons / indicators**
Use these buttons to obtain the desired musical pitch.
- 11 **MUSIC BASS control**
Adjusts the music tone of low frequency sound.
- 12 **MUSIC TREBLE control**
Adjusts the music tone of high frequency sound.
- 13 **ECHO REPEAT control**
Adjusts the repeating number of the echo.
- 14 **ECHO DELAY control**
Adjusts the echo length.
- 15 **MPX BALANCE control**
Adjusts the volume level between the original vocals and music when playing a sound multiplex source.
- 16 **BALANCE control**
Adjusts the balance between the left and right speakers.
- 17 **Remote control sensor**
Receives the signals emitted from the remote control.
- 18 **MIC LEVEL controls (1, 2)**
Adjust the microphone level.
- 19 **MIC jacks (1, 2)**
Connect a microphone.
- 20 **KEY CONTROL jack**
Connect the key control plug of the microphone to control the music pitch with the microphone.

BASIC OPERATION

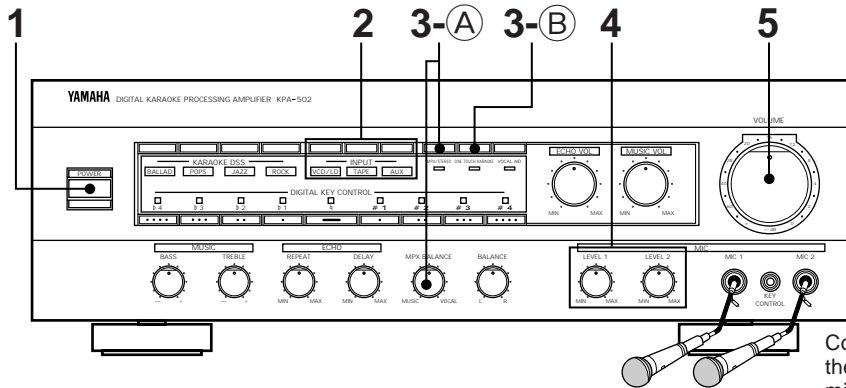

Connect the microphone(s) to the MIC jack(s) and turn on the microphone(s).

1 Turn on the power of this unit.

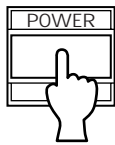

2 Select the source to be played with the INPUT selector and start playback. (Adjust the VOLUME control to the appropriate level.)

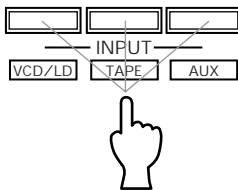

3 (A) When playing the sound multiplex source (sound multiplex karaoke disc or tape, etc.)

Press the MPX/STEREO button so that the indicator lights.

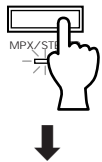

Adjust the MPX BALANCE control.
To decrease the volume level of the original vocals, turn the control toward "MUSIC".
To decrease the volume level of the music, turn the control toward "VOCAL".



(B) When playing a stereo source (general CDs or music tapes with vocals, etc.)

Make sure that the MPX/STEREO button is set to off. (The indicator goes off.)

Press the ONE TOUCH KARAOKE button so that the indicator lights.

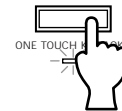

The volume of the original vocals is reduced and the music is mainly heard.
With some discs, however, the original vocals may remain heard.

4 Adjust the microphone level with the MIC LEVEL control(s) while speaking into the microphone(s).

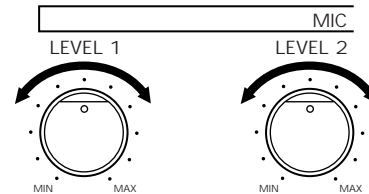

(For best results keep knobs set close to the center position.)

5 Re-adjust the overall volume with the VOLUME control.

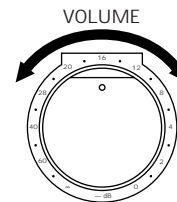

When howling (a high-pitched sound) occurs

Separate the microphone farther away from the speakers, decrease the microphone level, or lower the overall volume level with the VOLUME control.

Notes on the microphone

When the microphone is not being used, turn off the microphone switch or unplug the microphone.

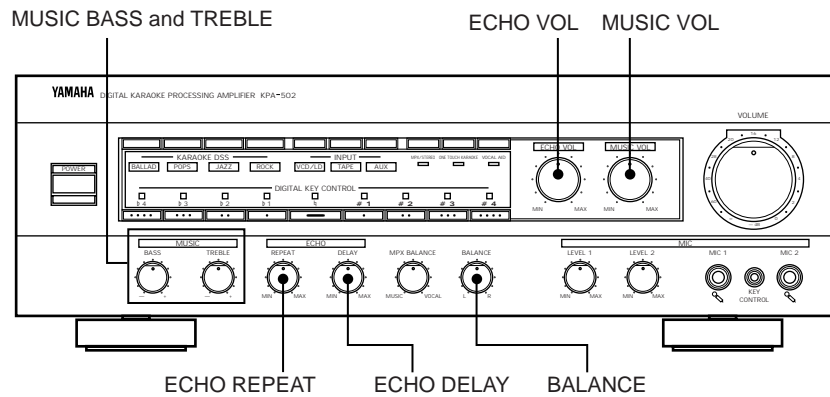

To adjust the balance between the left and right speakers

Turn the BALANCE control towards "R" to move the sound image to the right. To move the sound image to the left, turn the control towards "L".

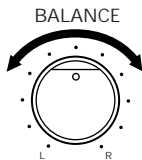

To adjust only the music volume

Turn the MUSIC VOL control towards "MAX" to increase the volume level of the input source other than the microphones volume. To decrease it, turn the control towards "MIN".

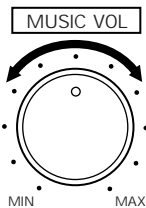

To adjust only the music tone

For high frequency sound

Turning the MUSIC TREBLE control towards "+" increases the level, while turning the control towards "-" decreases the level.

For low frequency sound

Turning the MUSIC BASS control towards "+" increases the level, while turning the control towards "-" decreases the level.

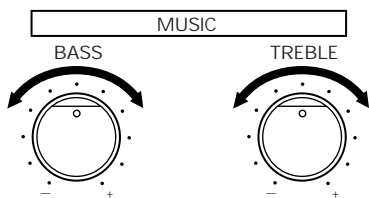

- If the sound is distorted by increasing the music tone level, turn down the MUSIC VOL control.
- The voices cannot be adjusted with these controls.

Adding the echo effect to your voice

The ECHO VOL, ECHO DELAY and ECHO REPEAT controls are used to adjust the echo effect.

To adjust the echo level

Turning the ECHO VOL control towards "MAX" increases the echo level, while turning the control towards "MIN" decreases it.

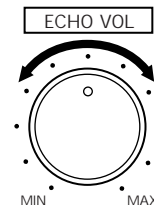

To adjust the echo length

Turning the ECHO DELAY control towards "MAX" expands the echo length, while turning the control towards "MIN" shortens it.

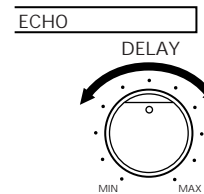

To adjust the repeating number of the echo

Turning the ECHO REPEAT control towards "MAX" increases the repeating number of the echo, while turning the control towards "MIN" decreases it.

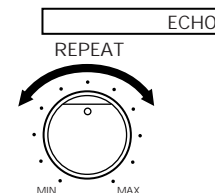

- The voices heard through the microphones have the same echo effect.

VARIOUS FUNCTIONS FOR KARAOKE PLAY

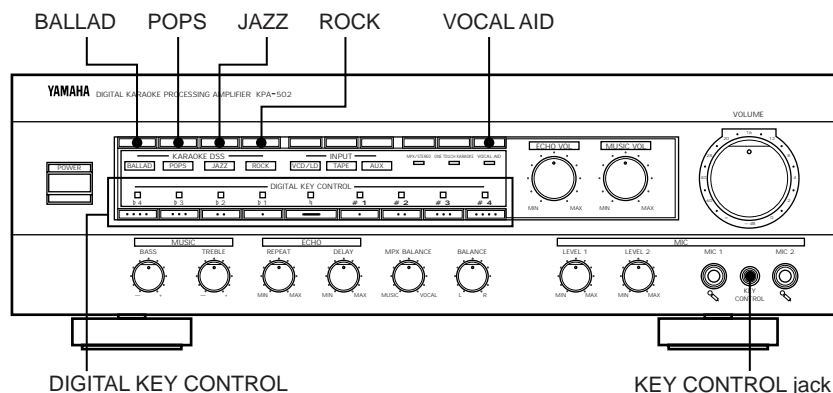

To replace original vocals with your voice when you sing

Press the VOCAL AID button so that the indicator lights. When you sing into the microphone, your voice replaces the original vocals.



- When playing the sound multiplex sources with the MPX setting of the MPX/STEREO button, adjust the MPX BALANCE control to balance the volume between original vocals and music.

To obtain an atmosphere according to the music type

Press one of the buttons to select the suitable effect for the music type you sing.

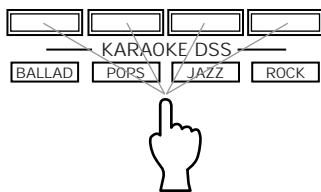

- BALLAD:** Suitable for mellow songs with slow-tempo; you can sing with expressions.
- POPS:** Suitable for pop music; you can sing with light-feelings.
- JAZZ:** Provides the reflections like in a small hall, which give an atmosphere similar to a jazz club.
- ROCK:** Suitable for dynamic and rhythmical rock sound.

Press the same button again to cancel the effect.

- This function has effect on both of the background music and the sound through the microphone.

To obtain the desired musical pitch

Use the DIGITAL KEY CONTROL buttons to obtain the desired musical pitch (± 2 note, 9 steps). The DIGITAL KEY CONTROL indicators (± 4 and normal indicators) display the selected pitch.

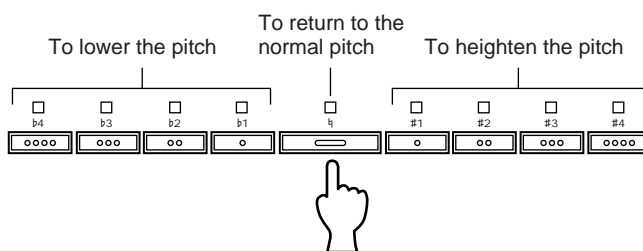

NOTES:

- If the input signal is interrupted for about 4 seconds, the setting will return to the normal pitch.
- If another button of the INPUT selector is pressed, the musical pitch returns to the normal pitch.

Controlling the musical pitch with microphone

It is also possible to control the musical pitch with the microphone provided with the key control plug (available in some areas).

Connect the microphone to the MIC 1 or MIC 2 jack, and insert its key control plug in the KEY CONTROL jack next to the MIC jack.

To record karaoke play

Karaoke play can be recorded with the cassette deck connected to this unit. Before recording, set the INPUT selector to the VCD/LD or AUX position according to the source to be played.

NOTES:

- During playback of the cassette deck, the input signal of the TAPE PLAY jacks and your voices are not output from the TAPE REC jacks. Thus, you cannot record that signals even when other cassette decks are connected.
- The settings of MUSIC BASS, MUSIC TREBLE and DIGITAL KEY CONTROLS, etc. are reflected to the recorded sound. Therefore, the recorded sound will be similar to the sound output from the speakers.

REMOTE CONTROL TRANSMITTER

With the remote control transmitter provided with this unit, you can operate the unit at your listening/singing position.

The buttons on the remote control transmitter have the same functions as those with the identical names on the main unit. For detailed instructions, refer to the descriptions on the corresponding buttons on the main unit.

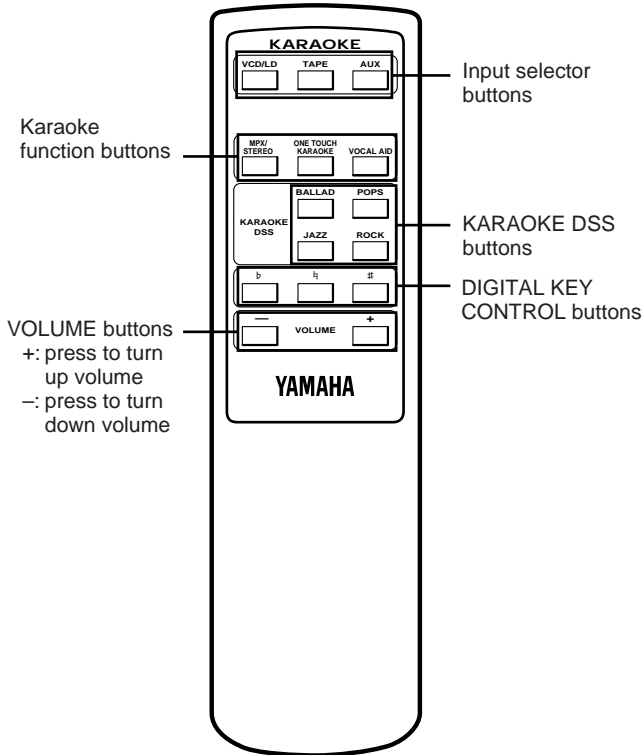

REMOTE CONTROL OPERATION RANGE

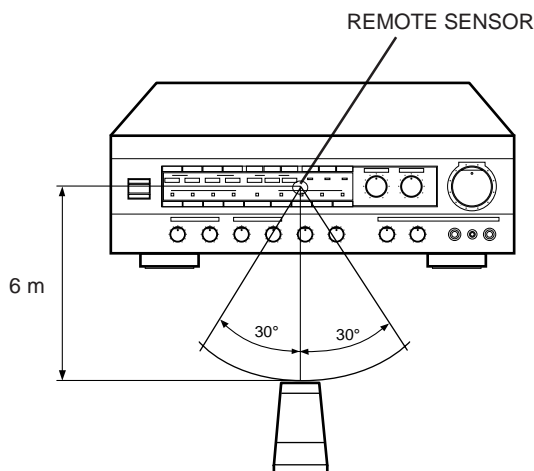

Battery installation

- ① Pull out the battery compartment lid in the direction of the arrow.
- ② Install the batteries (size AA, R6, UM-3) with correct polarities. Follow the diagram in the compartment.
- ③ Push the compartment lid in until it clicks into place.

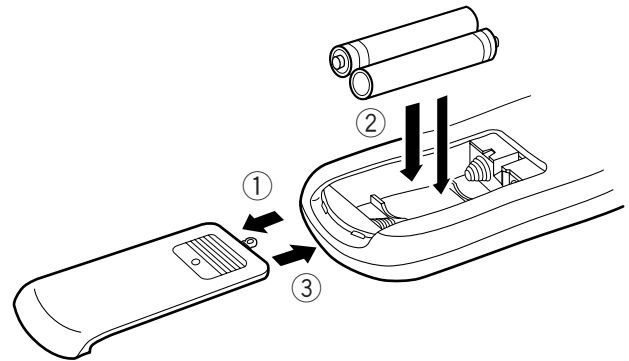

Battery replacement

If you find that the remote control transmitter must be used closer to the main unit, the batteries are weak. Replace both batteries with new ones.

NOTES:

- Use only AA, R6, UM-3 batteries for replacement.
- Be sure that the polarities are correct. (See the illustration inside the battery compartment.)
- Remove the batteries if the remote control transmitter will not be used for an extended period of time.
- If batteries leak, dispose of them immediately. Avoid touching the leaked material or letting it come in contact with clothing, etc. Clean the battery compartment thoroughly before installing new batteries.

TROUBLESHOOTING

If this unit functions abnormally during operation, first check the following items. If the unit continues to function abnormally, or if an abnormality occurs other than those listed below, switch off the unit's power and disconnect the AC plug, and then consult your authorized YAMAHA dealer or servicing personnel.

SYMPTOM	POSSIBLE CAUSE	REMEDY
Your voice is not heard through the microphone.	Microphone plug is not firmly inserted to the jack.	Insert firmly.
	Microphone is turned off.	Turn on the power of the microphone.
	The MIC LEVEL is set to MIN	Set the MIC LEVEL to an appropriate level.
The volume of the original vocals cannot be reduced even when the MPX BALANCE control is turned to the MUSIC side.	The MPX/STEREO button is not set properly.	With sound multiplex sources, set the MPX/STEREO button to on. (The indicator lights.)
Your voice cannot replace the original vocals even when the ONE TOUCH KARAOKE button is pressed.	The volume level of the microphone is low.	Turn up the volume of the microphone with the MIC LEVEL control.
	The singing voice level is not loud enough.	Sing louder.
The sound of the playback source is not heard.	The INPUT selector is not set properly.	Set it to the source to be played.
It happens that this unit does not work normally	There is an influence of strong external noise (lightning, excessive static electricity, etc.) or a misoperation was performed while using this unit.	Turn this unit power off and disconnect the AC power from the AC outlet. After about 30 seconds have passed, connect the power and try again.

NOTE:

When the unit fails to operate normally because of some reasons, turn the power on and off by pressing the POWER button. The microcomputer inside the unit is reset through this procedure.

SPECIFICATIONS

<Audio>

Minimum RMS Output Power per Channel 75W + 75W
 (0.05% THD, 20Hz~20kHz, 6 ohms, both channels driven)
Rated Output RMS Power (EIAJ) 100W + 100W
Input Sensitivity/Impedance
 MIC 1.0 mV/30 kohms
 VCD/LD, TAPE, AUX 150 mV/50 kohms
Output Level/Impedance (Input Level: 150 mV)
 PRE OUT 1 V/1 kohms
 REC OUT 150 mV/1 kohms
Music Tone Control Characteristic
 BASS (Boost/Cut) +9 dB/-9 dB (50 Hz)
 TREBLE (Boost/Cut) +8 dB/-8 dB (10 kHz)

<Video>

Video Input Level/Impedance
 VCD/LD, AUX 1 Vp-p/75 ohms
Video Output Level/Impedance
 MONITOR 1, 2 1Vp-p/75 ohms

<General and China model>

Power Supply AC 110/120/220/240 V, 50/60 Hz
Power Consumption 145 W
AC Outlet (2 UNSWITCHED OUTLETS) ... 100 W max. total

(U.S.A. model)

Power Supply AC 120 V, 60 Hz
Power Consumption 140 W
AC Outlet (2 UNSWITCHED OUTLETS) ... 100 W max. total

(Singapore model)

Power Supply AC 230 V, 50 Hz
Power Consumption 145 W
AC Outlet (2 UNSWITCHED OUTLETS) ... 100 W max. total

Dimensions (W x H x D) 420 x 141 x 434 mm
Weight 10.4 kg

Specifications are subject to change without notice.

YAMAHA

YAMAHA ELECTRONICS CORPORATION, USA 6660 ORANGETHORPE AVE., BUENA PARK, CALIF. 90620, U.S.A.
YAMAHA CANADA MUSIC LTD. 135 MILNER AVE., SCARBOROUGH, ONTARIO M1S 3R1, CANADA
YAMAHA ELECTRONIK EUROPA G.m.b.H. SIEMENSSTR, 22-34, 25462 RELLINGEN, BEI HAMBURG, F.R. OF GERMANY
YAMAHA ELECTRONIQUE FRANCE S.A. RUE AMBROISE CROIZAT BP70 CROISSY-BEAUBOURG 77312 MARNE-LA-VALLEE CEDEX02, FRANCE
YAMAHA ELECTRONICS (UK) LTD. YAMAHA HOUSE, 200 RICKMANSWORTH ROAD WATFORD, HERTS WD1 7JS, ENGLAND
YAMAHA SCANDINAVIA A.B. J A WETTERGRENS GATA 1, BOX 30053, 400 43 VASTRA FRÖLUNDA, SWEDEN
YAMAHA MUSIC AUSTRALIA PTY, LTD. 17-33 MARKET ST., SOUTH MELBOURNE, 3205 VIC., AUSTRALIA

YAMAHA CORPORATION

Printed in Malaysia

V203450