

YAMAHA

RX-V493RDS

RX-V393RDS

Natural Sound AV Receiver

Récepteur audiovisuel "Son Naturel"

Natural Sound AV-Receiver

Natural Sound AV-receiver

Sintonizzatore AV a suono naturale

Receptor AV de Sonido Natural

Natural Sound AV Ontvanger

**OWNER'S MANUAL
MODE D'EMPLOI
BEDIENUNGSANLEITUNG
BRUKSANVISNING
MANUALE DI ISTRUZIONI
MANUAL DE INSTRUCCIONES
GEBRUIKSAANWIJZING**

SUPPLIED ACCESSORIES
ACCESSOIRES FOURNIS
MITGELIEFERTE ZUBEHÖRTEILE
MEDFÖLJANDE TILLBEHÖR
ACCESSORI IN DOTAZIONE
ACCESORIOS INCLUIDOS
BIJGELEVERDE ACCESSOIRES

- After unpacking, check that the following parts are included.
- Après le déballage, vérifier que les pièces suivantes sont incluses.
- Nach dem Auspacken überprüfen, ob die folgenden Teile vorhanden sind.
- Kontrollera efter det apparaten packats upp att följande delar finns med.
- Verificare che tutte le parti seguenti siano contenute nell'imballaggio dell'apparecchio.
- Desembalar el aparato y verificar que los siguientes accesorios están en la caja.
- Controleer na het uitpakken of de volgende onderdelen voorhanden zijn.

- Indoor FM Antenna
- Antenne FM intérieure
- UKW-Innenantenne
- FM inomhusantenn
- Antenna FM interna
- Antena FM interior
- FM Binnenantenne

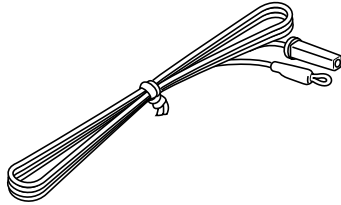

- Remote Control Transmitter
- Télécommande
- Fernbedienung
- Fjärrkontroll
- Telecomando
- Transmisor de control remoto
- Afstandbediening

RX-V493RDS

RX-V393RDS

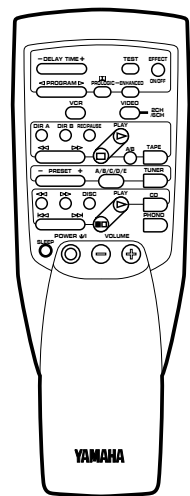
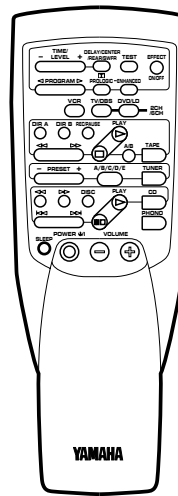

- AM Loop Antenna
- Cadre-antenne AM
- MW-Rahmenantenne
- AM ramantenn
- Antenna AM ad anello
- Antena de cuadro de AM
- AM Lusantenne

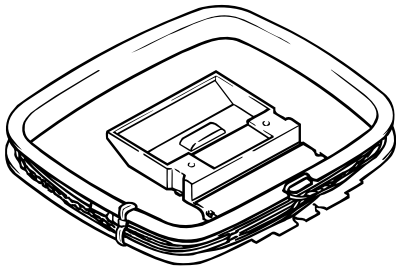

- Batteries (size AA, R6, UM-3)
- Piles (taille AA, R6, UM-3)
- Batterien (Größe AA, R6, UM-3)
- Batterier (storlek AA, R6, UM-3)
- Batterie (dimensioni AA, R6, UM-3)
- Pilas (tamaño AA, R6, UM-3)
- Batterijen (maat AA, R6, UM-3)

- 75-ohm/300-ohm antenna adapter (U.K. model only)
- Adaptateur d'antenne 75 ohms/300 ohms (Modèle pour le Royaume-Uni seulement)
- 75 Ohm/300 Ohm Antennenstecker (nur Großbritannien-Modell)
- 75 ohm/300 ohm antennadapter (Endast modell för Storbritannien)
- Adattatore per antenna da 75 e 300 ohm (Solo modello per la Gran Bretagna)
- Adaptador de antena de 75 ohmios/300 ohmios (Modelo para Reino Unido sólo)
- 75 ohm/300 ohm antenne-adapter (Alleen modellen voor Groot-Brittannië)

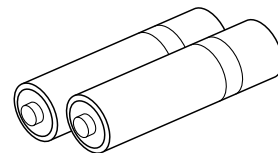
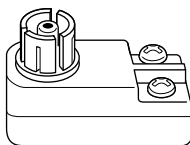

FEATURES

● 5 Speaker Configuration (Power Amp. Section)

RX-V493RDS

- Main:** 65W + 65W (8Ω) RMS Output Power, 0.04% THD, 20–20,000 Hz
- Center:** 65W (8Ω) RMS Output Power, 0.04% THD, 1 kHz
- Rear:** 20W + 20W (8Ω) RMS Output Power, 0.04% THD, 1 kHz

RX-V393RDS

- Main:** 50W + 50W (8Ω) RMS Output Power, 0.04% THD, 20–20,000 Hz
- Center:** 50W (8Ω) RMS Output Power, 0.04% THD, 1 kHz
- Rear:** 20W + 20W (8Ω) RMS Output Power, 0.04% THD, 1 kHz

- Digital Sound Field Processor
- Dolby Pro Logic Surround Decoder
- Theater-like Sound Experience by the Combination of Dolby Pro Logic and YAMAHA DSP Technology (CINEMA DSP)

- Automatic Input Balance Control for Dolby Pro Logic Surround
- Test Tone Generator for Easier Speaker Balance Adjustment
- 3 Center Channel Modes (NORMAL/WIDE/PHANTOM)
- Multi-Functions for RDS Broadcast Reception
- 40-Station Random Access Preset Tuning
- Automatic Preset Tuning
- Preset Station Shifting Capability (Preset Editing)
- IF Count Direct PLL Synthesizer Tuning System
- 6-Channel Discrete Input Terminals for Connecting with a Dolby Digital (AC-3) Decoder
- Video Signal Input/Output Capability
- SLEEP Timer
- Remote Control Capability

CONTENTS

SUPPLIED ACCESSORIES	2	BASIC OPERATIONS	25
FEATURES	3	TUNING OPERATIONS	29
CAUTION	4	PRESET TUNING	30
NOTES ABOUT THE REMOTE CONTROL TRANSMITTER	5	RECEIVING RDS STATIONS	33
PROFILE OF THIS UNIT	6	USING DIGITAL SOUND FIELD PROCESSOR (DSP)	38
SPEAKER SETUP	7	SETTING THE SLEEP TIMER	42
CONNECTIONS	8	TROUBLESHOOTING	43
CONTROLS AND THEIR FUNCTIONS	16	SPECIFICATIONS	44
SPEAKER BALANCE ADJUSTMENT	22		

CAUTION : READ THIS BEFORE OPERATING YOUR UNIT.

1. To assure the finest performance, please read this manual carefully. Keep it in a safe place for future reference.
2. Install this unit in a cool, dry, clean place – away from windows, heat sources, sources of excessive vibration, dust, moisture and cold. Avoid sources of humming (transformers, motors). To prevent fire or electrical shock, do not expose the unit to rain or water.
3. Never open the cabinet. If something drops into the set, contact your dealer.
4. Do not use force on switches, controls or connection wires. When moving the unit, first disconnect the power plug and the wires connected to other equipment. Never pull the wires themselves.
5. The openings on the cabinet assure proper ventilation of the unit. If these openings are obstructed, the temperature inside the cabinet will rise rapidly. Therefore, avoid placing objects against these openings, and install the unit in well-ventilated condition. Be sure to allow a space of at least 20 cm behind, 20 cm on the both sides and 30 cm above the top panel of the unit. Otherwise it may not only damage the unit, but also cause fire.
6. Always set the VOLUME control to “– ∞” before starting the audio source play. Increase the volume gradually to an appropriate level after playback has been started.
7. Do not attempt to clean the unit with chemical solvents; this might damage the finish. Use a clean, dry cloth.
8. Be sure to read the “TROUBLESHOOTING” section regarding common operating errors before concluding that the unit is faulty.
9. When not planning to use this unit for long periods of time (ie., vacation, etc.), disconnect the AC power plug from the wall outlet.
10. To prevent lightning damage, disconnect the AC power plug and antenna cable when there is an electrical storm.
11. Grounding or polarization – Precautions should be taken so that the grounding or polarization of an appliance is not defeated.
12. Do not connect audio equipment to the AC outlet on the rear panel if the equipment requires more power than the outlet is rated to provide.

This unit is not disconnected from the AC power source as long as it is connected to the wall outlet, even if this unit itself is turned off. This state is called the standby mode. In this state, this unit is designed to consume a very small quantity of power.

IMPORTANT

Please record the serial number of this unit in the space below.

Model:

Serial No.:

The serial number is located on the rear of the unit. Retain this Owner's Manual in a safe place for future reference.

WARNING

TO REDUCE THE RISK OF FIRE OR ELECTRIC SHOCK, DO NOT EXPOSE THIS UNIT TO RAIN OR MOISTURE.

For U.K. customers

If the socket outlets in the home are not suitable for the plug supplied with this appliance, it should be cut off and an appropriate 3 pin plug fitted. For details, refer to the instructions described below.

Note: The plug severed from the mains lead must be destroyed, as a plug with bared flexible cord is hazardous if engaged in a live socket outlet.

Special Instructions for U.K. Model

IMPORTANT

THE WIRES IN MAINS LEAD ARE COLOURED IN ACCORDANCE WITH THE FOLLOWING CODE:

Blue: NEUTRAL

Brown: LIVE

As the colours of the wires in the mains lead of this apparatus may not correspond with the coloured markings identifying the terminals in your plug, proceed as follows: The wire which is coloured BLUE must be connected to the terminal which is marked with the letter N or coloured BLACK. The wire which is coloured BROWN must be connected to the terminal which is marked with the letter L or coloured RED. Making sure that neither core is connected to the earth terminal of the three pin plug.

WARNING

Do not change the **IMPEDANCE SELECTOR** switch setting while the power to this unit is on, otherwise this unit may be damaged.

IF THIS UNIT FAILS TO TURN ON WHEN THE STANDBY/ON SWITCH IS PRESSED

The **IMPEDANCE SELECTOR** switch may not be set to either end closely. If so, set the switch to either end closely.

IMPEDANCE SELECTOR

(Europe model)

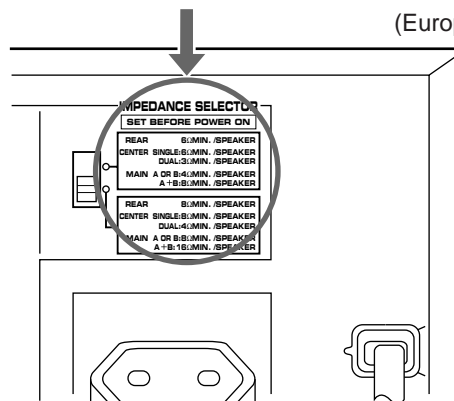

NOTES ABOUT THE REMOTE CONTROL TRANSMITTER

Battery installation

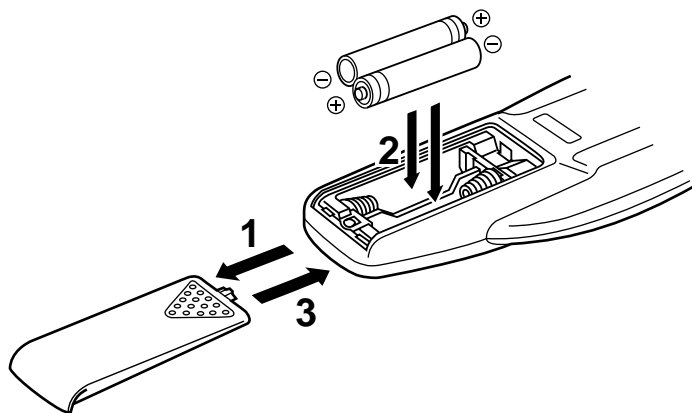

Remote control transmitter operation range

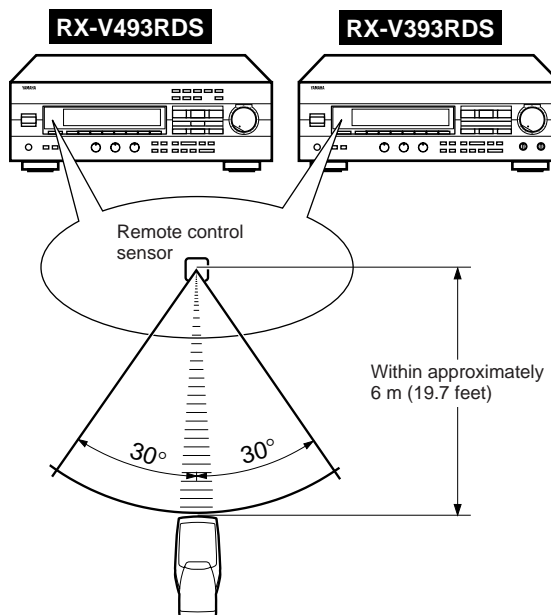

Battery replacement

If you find that the remote control transmitter must be used closer to the main unit, the batteries are weak. Replace both batteries with new ones.

Notes

- Use only AA, R6, UM-3 batteries for replacement.
- Be sure the polarities are correct. (See the illustration inside the battery compartment.)
- Remove the batteries if the remote control transmitter will not be used for an extended period of time.
- If batteries leak, dispose of them immediately. Avoid touching the leaked material or letting it come in contact with clothing, etc. Clean the battery compartment thoroughly before installing new batteries.

Notes

- There should be no large obstacles between the remote control transmitter and the main unit.
- If the remote control sensor is directly illuminated by strong lighting (especially an inverter type of fluorescent lamp etc.), it might cause the remote control transmitter not to work correctly. In this case, reposition the main unit to avoid direct lighting.

PROFILE OF THIS UNIT

You are the proud owner of a Yamaha stereo receiver –an extremely sophisticated audio component. The Digital Sound Field Processor (DSP) built into this unit takes advantage of Yamaha’s undisputed leadership in the field of digital audio processing to bring you a whole new world of listening experiences. Follow the instructions in this manual carefully when setting up your system, and this unit will sonically transform your room into a wide range of listening environments –movie theater, concert hall, and so on. In addition, you get incredible realism from sources encoded with Dolby Surround using the built-in Dolby Pro Logic Surround Decoder.

Please read this operation manual carefully and store it in a safe place for later reference.

Digital Sound Field Processing

What is it that makes live music so good? Today’s advanced sound reproduction technology lets you get extremely close to the sound of a live performance, but chances are you’ll still notice something missing: the acoustic environment of the live concert hall. Extensive research into the exact nature of the sonic reflections that create the ambience of a large hall has made it possible for Yamaha engineers to bring you this same sound in your own listening room, so you’ll feel all the sound of a live concert.

Furthermore, our technicians, armed with sophisticated measuring equipment, have even made it possible to capture the acoustics of a variety of venues such as an actual concert hall, theater, etc. to allow you to accurately recreate one of several actual live performance environments, all in your own home.

Dolby Pro Logic Surround

This unit employs a Dolby Pro Logic Surround decoder similar to professional Dolby Stereo decoders used in many movie theaters. By using the Dolby Pro Logic Surround decoder, you can experience the dramatic realism and impact of Dolby Surround movie theater sound in your own home. Dolby Pro Logic employs a four channel five speaker system. The Pro Logic Surround system divides the input signal into four levels: the left and right main channels, the center channel (used for dialog), and the rear surround sound channels (used for sound effects, background noise, and other ambient noises). The center channel allows listeners seated in even less-than-ideal positions to hear the dialog originating from the action on the screen while experiencing good stereo imaging. Dolby Surround is encoded on the sound track of pre-recorded video tapes, laser discs, and some TV/cable broadcasts. When you play a source encoded with Dolby Surround on this unit, the Dolby Pro Logic Surround decoder decodes the signal and distributes the surround-sound effects.

This Dolby Pro Logic Surround Decoder employs a digital signal processing system. This system improves the stability of sound at each channel and minimizes crosstalk between channels, so that positioning of sounds around the room is more accurate compared with conventional analog signal processing systems. In addition, this unit features a built-in automatic input balance control. This always assures you the best performance without manual adjustment.

Manufactured under license from Dolby Laboratories Licensing Corporation. “Dolby”, “AC-3”, “Pro Logic” and the double-D symbol are trademarks of Dolby Laboratories Licensing Corporation.

Dolby Pro Logic Surround + DSP

Dolby Surround sound system shows its full ability in a large movie theater, because movie sounds are originally designed to be reproduced in a large movie theater using many speakers. It is difficult to create a sound environment similar to that of a movie theater in your listening room, because the room size, materials of inside walls, the number of speakers, etc. of your listening room is much different from those of a movie theater.

Yamaha DSP technology made it possible to present you with nearly the same sound experience as that of a large movie theater in your listening room by compensating for lack of presence and dynamics in your listening room with its original digital sound fields combined with Dolby Surround sound field.

The combination of Dolby Pro Logic Surround and DSP is used on the sound field program “ PRO LOGIC ENHANCED”.

CINEMA DSP

The YAMAHA “CINEMA DSP” logo indicates these programs are created by the combination of Dolby Pro Logic and YAMAHA DSP technology.

SPEAKER SETUP

SPEAKERS TO BE USED

This unit is designed to provide the best sound-field quality with a 5 speaker configuration. The most effective speakers to use with this unit are main speakers, rear speakers and a center speaker. You may omit the center speaker. (Refer to the “**4-Speaker Configuration**” shown below.)

The main speakers are used for the main source sound plus the effect sounds. They will probably be the speakers from your present stereo system. The rear speakers are used for the effect and surround sounds, and the center speaker is for the center sounds (dialog etc.) within programs encoded with Dolby Surround. The center speaker needs to be equal in power to the main speakers, although the rear speakers should not be equal. However, all the speakers should have high enough power handling to accept the maximum output of this unit.

SPEAKER CONFIGURATION

5-Speaker Configuration

This configuration is the most effective and recommended one. In this configuration, the center speaker is necessary as well as the rear speakers. If the program **DOLBY PRO LOGIC** or **DOLBY PRO LOGIC ENHANCED** is selected, conversations will be output from the center speaker and the ambience will be excellent.

- Set the center channel mode to the “**NORMAL**” or “**WIDE**” position. (For details, refer to page 23.)

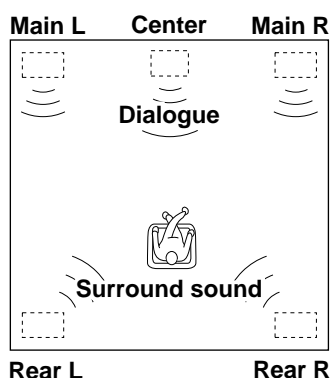

4-Speaker Configuration

The center speaker is not used in this configuration. If the program **DOLBY PRO LOGIC** or **DOLBY PRO LOGIC ENHANCED** is selected, the center sound is output from the left and the right main speakers. However, the sound effect of other programs can be the same as that of the 5-speaker configuration.

- Be sure to set the center channel mode to the “**PHANTOM**” position. (For details, refer to page 23.)

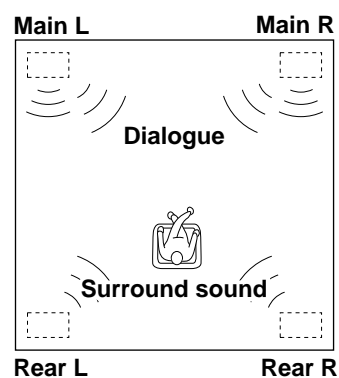

SPEAKER PLACEMENT

The recommended speaker configuration, the 5-speaker configuration, will require two speaker pairs: **main speakers** (your normal stereo speakers), and **rear speakers**, plus a **center speaker**. When you place these speakers, refer to the following.

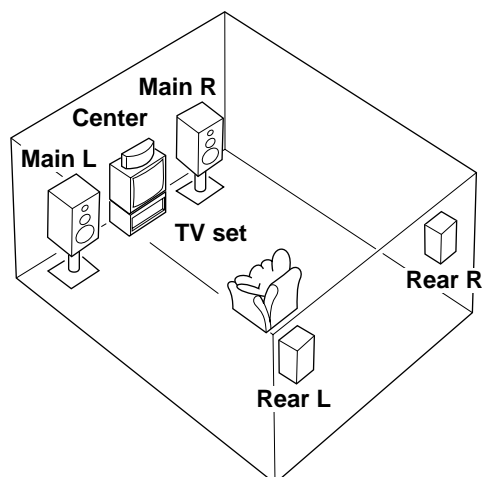

- Main:** In normal position. (The position of your present stereo speaker system.)
- Rear:** Behind your listening position, facing slightly inward. Nearly 1.8m (approx. 6 feet) up from the floor.
- Center:** Precisely between the main speakers. (To avoid interference with TV sets, use a magnetically shielded speaker.)

CONNECTIONS

Never plug in this unit and other components until all connections are completed.

CONNECTIONS WITH OTHER COMPONENTS

When making connections between this unit and other components, be sure all connections are made correctly, that is to say L (left) to L, R (right) to R, “+” to “+” and “-” to “-”. Also, refer to the owner’s manual for each component to be connected to this unit.

* If you have YAMAHA components numbered as 1, 3, 4, etc. on the rear panel, connections can be made easily by making sure to connect the output (or input) terminals of each component to the same-numbered terminals of this unit.

RX-V493RDS

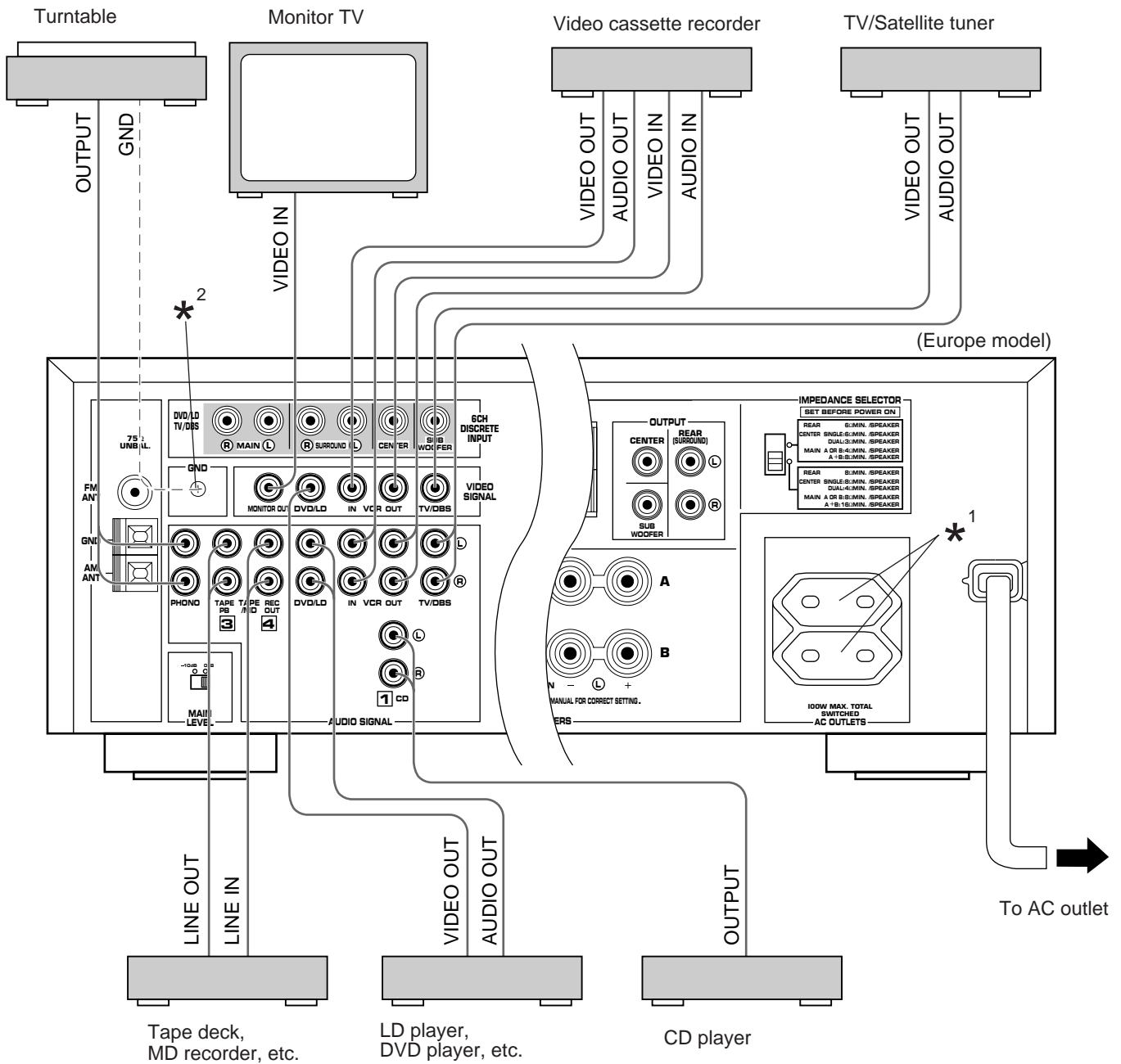

*¹, *² : See the next page.

RX-V393RDS

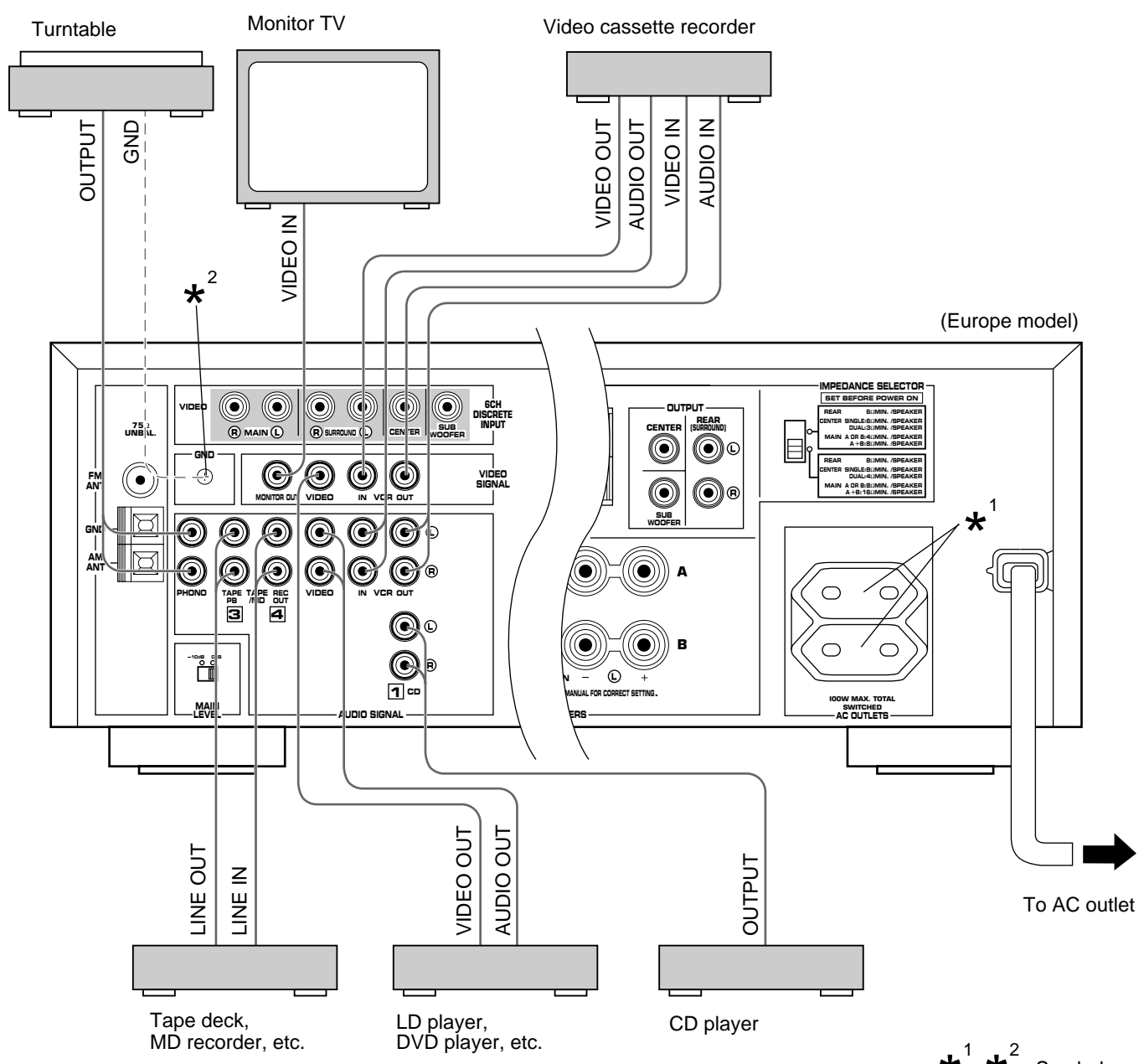

*¹, *² : See below.

***¹ AC OUTLETS (SWITCHED)**
 (Europe model) 2 SWITCHED OUTLETS
 (U.K. model) 1 SWITCHED OUTLET
 Use these to connect the power cords from your components to this unit.
 The power to the **SWITCHED** outlets is controlled by this unit's **STANDBY/ON** switch or the provided remote control transmitter's **POWER** key. These outlets will supply power to any component whenever this unit is turned on.
 The maximum power (total power consumption of components) that can be connected to the **SWITCHED AC OUTLETS** is 100 watts.

***² GND terminal (For turntable use)**
 Connecting the ground wire of the turntable to the **GND** terminal will normally minimize hum, but in some cases better results may be obtained with the ground wire disconnected.

Connecting with 6 channel discrete outputs of a Dolby digital (AC-3) decoder or a DVD player, etc.

If you have a Dolby Digital (AC-3) decoder or a DVD player etc. which incorporates a Dolby Digital (AC-3) decoder or a DTS decoder, its 6 channel discrete outputs can be connected to the 6CH DISCRETE INPUT terminals of this unit.

RX-V493RDS

(Example)

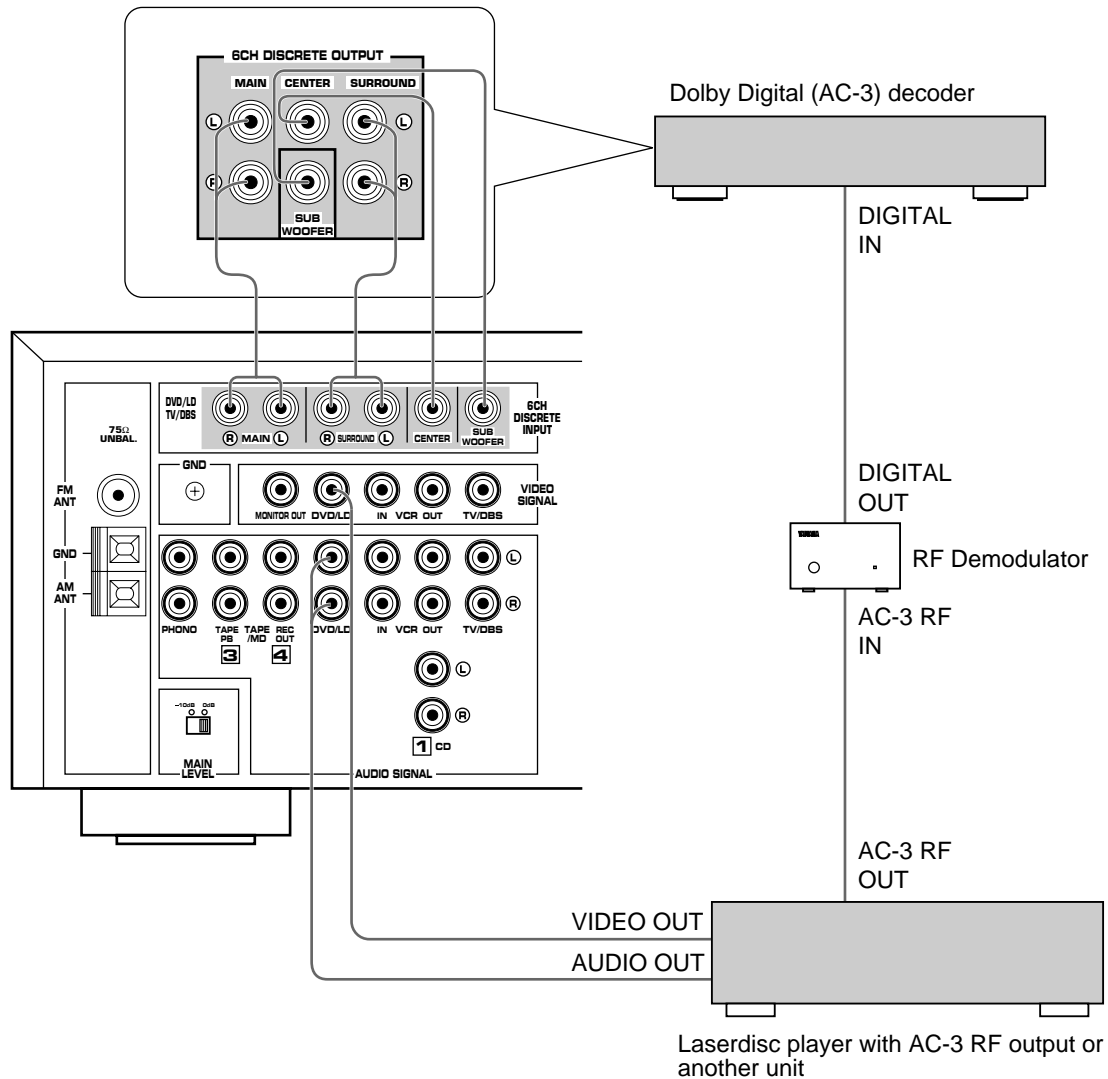

Notes for RX-V493RDS

- The laserdisc player (or another unit) must be also connected to the DVD/LD (or TV/DBS) AUDIO SIGNAL input terminals of this unit for playing a source with the Dolby Pro Logic Surround decoded or in normal stereo (or monaural).
- The discrete signals input to this unit cannot be recorded by a tape deck, MD recorder or VCR. To record a source played on the laserdisc player (or another unit), it must be connected to the DVD/LD (or TV/DBS) AUDIO/VIDEO SIGNAL input terminals of this unit.
- If you made no connection to the SUBWOOFER input terminal of this unit or you will not use a subwoofer, you should make a setting for distributing signals at the SUBWOOFER channel to the right and left MAIN output terminals on the Dolby Digital (AC-3) decoder etc. For details, refer to the owner's manual for the Dolby Digital (AC-3) decoder etc.

RX-V393RDS

(Example)

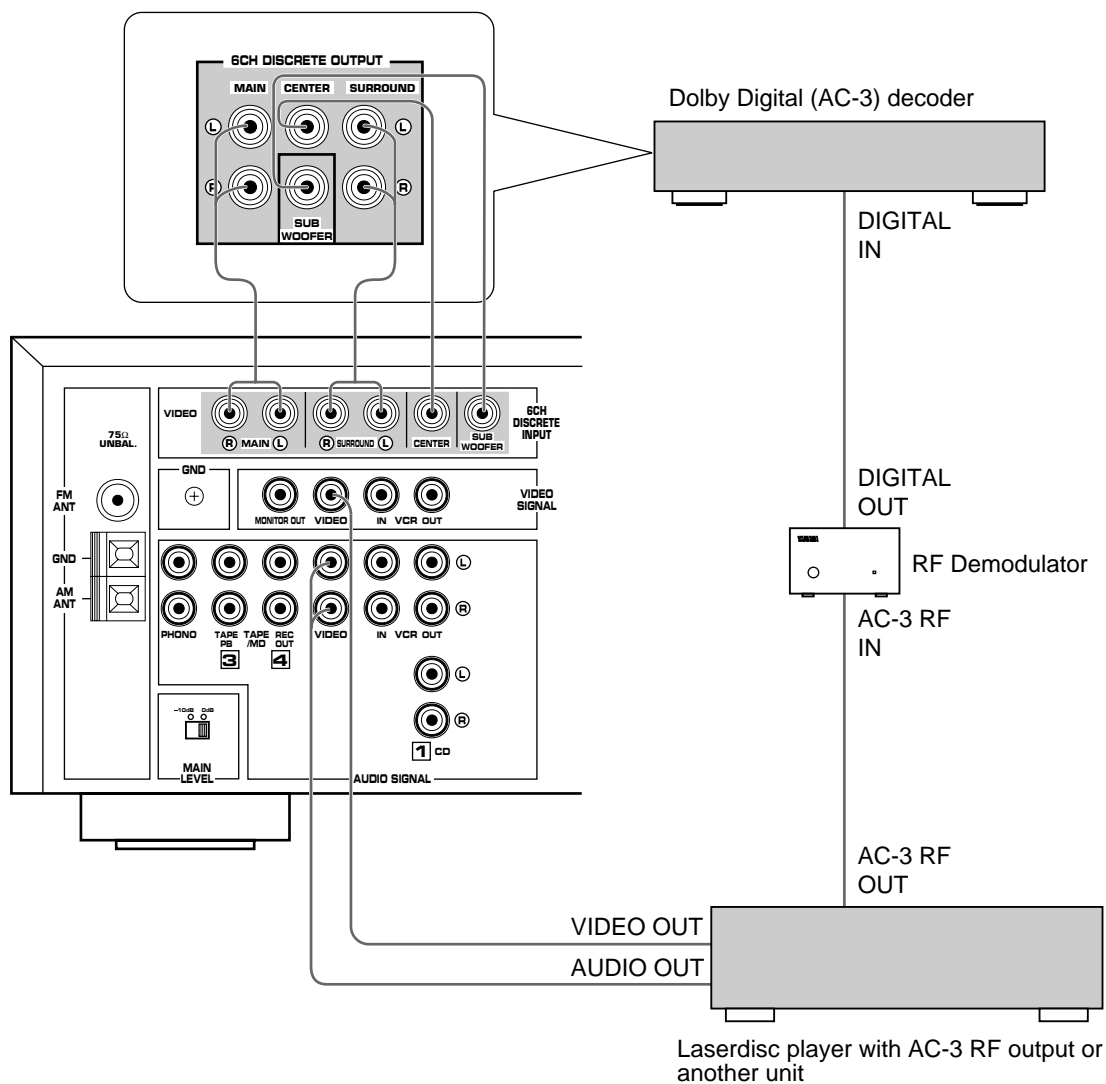
**Notes for RX-V393RDS**

- The laserdisc player (or another unit) must be also connected to the VIDEO AUDIO SIGNAL input terminals of this unit for playing a source with the Dolby Pro Logic Surround decoded or in normal stereo (or monaural).
- The discrete signals input to this unit cannot be recorded by a tape deck, MD recorder or VCR. To record a source played on the laserdisc player (or another unit), it must be connected to the VIDEO AUDIO/VIDEO SIGNAL input terminals of this unit.
- If you made no connection to the SUBWOOFER input terminal of this unit or you will not use a subwoofer, you should make a setting for distributing signals at the SUBWOOFER channel to the right and left MAIN output terminals on the Dolby Digital (AC-3) decoder etc. For details, refer to the owner's manual for the Dolby Digital (AC-3) decoder etc.

CONNECTING SPEAKERS

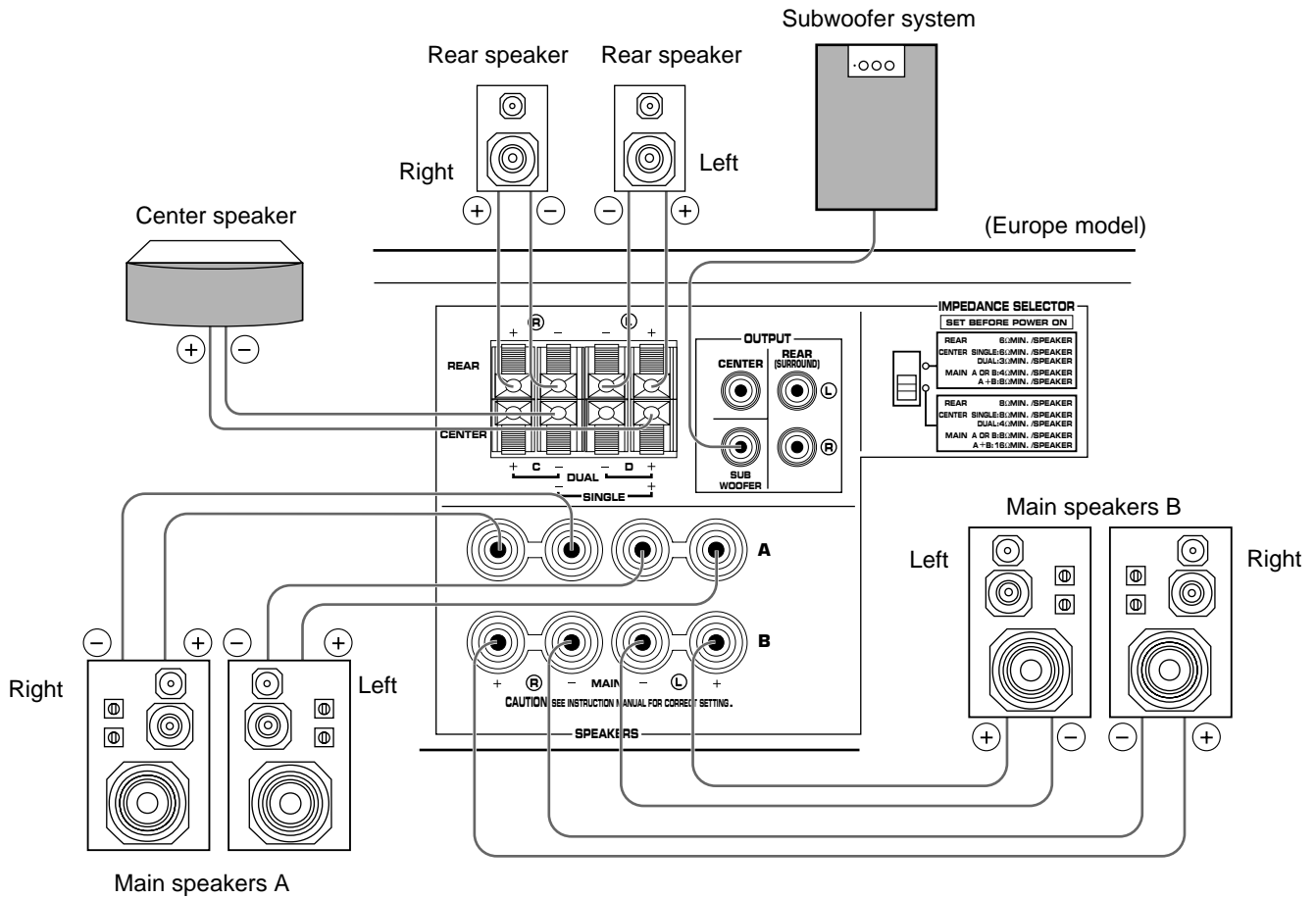

Note
Use speakers with the specified impedance shown on the rear of this unit.

Note on main speaker connections:
One or two speaker systems can be connected to this unit. If you use only one speaker system, connect it to either the **SPEAKERS A** or **B** terminals.

Note on a subwoofer connection:
You may wish to add a subwoofer to reinforce low frequencies or to output low bass sound from the subwoofer channel when reproducing discrete signals. Connect the **SUBWOOFER OUTPUT** terminal of this unit to the **INPUT** terminal of the subwoofer amplifier, and connect the speaker terminals of the subwoofer amplifier to the subwoofer. With some subwoofers, including the Yamaha Active Servo Processing Subwoofer System, the amplifier and subwoofer are in the same unit.

Note on center speaker connection:
One or two center speakers can be connected to this unit. If you cannot place the center speaker on or under the TV, it is recommended to use two center speakers and place them on both sides of the TV to orient the center sound at the center position. For connecting two center speakers, follow the method shown below.

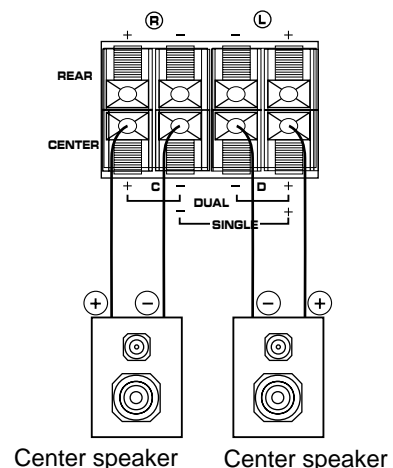

How to Connect:

Connect the **SPEAKERS** terminals to your speakers with wire of the proper gauge, cut as short as possible. If the connections are faulty, no sound will be heard from the speakers. Make sure that the polarity of the speaker wires is correct, that is the + and – markings are observed. If these wires are reversed, the sound will be unnatural and lack bass.

Caution

Do not let the bare speaker wires touch each other or any metal part of this unit. This could damage this unit and/or speakers.

For connecting to the MAIN SPEAKERS terminals

Red: positive (+)
Black: negative (-)

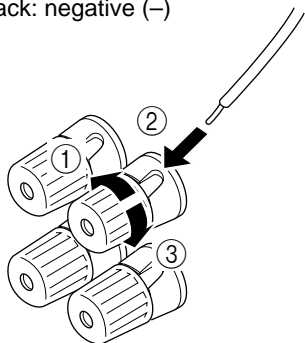

- ① Unscrew the knob.
- ② Insert the bare wire.
[Remove approx. 5mm (1/4") insulation from the speaker wires.]
- ③ Tighten the knob and secure the wire.

For connecting to the REAR and CENTER SPEAKERS terminals

Red: positive (+)
Black: negative (-)

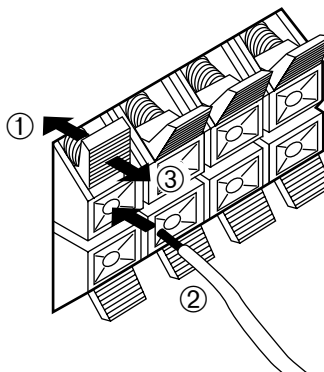

- ① Press the tab.
- ② Insert the bare wire.
[Remove approx. 5mm (1/4") insulation from the speaker wires.]
- ③ Release the tab and secure the wire.

MAIN LEVEL switch

Normally set to "0 dB". If desired, you can decrease the output level at the **MAIN SPEAKERS** terminals by 10 dB by setting this switch to "-10 dB".

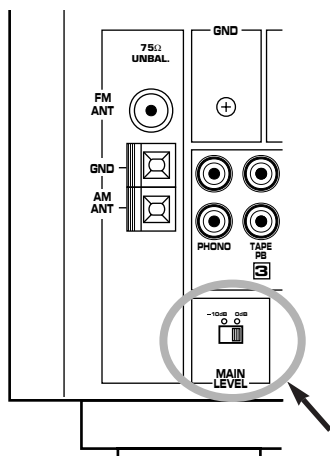

OUTPUT terminals (for driving speakers with external amplifiers)

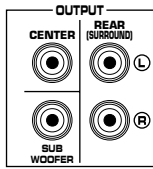

CENTER OUTPUT terminal

This terminal is for center channel line output. There is no connection to this terminal when you use the built-in amplifier. However, if you drive a center speaker with an external power amplifier, connect the input terminal of the external amplifier to this terminal.

SUBWOOFER OUTPUT terminal

This terminal is for connecting with the input terminal of an amplifier for driving a subwoofer.

This terminal outputs low frequencies from the main and center channels. (The cut-off frequency of signals output from this terminal is 150 Hz.)

When 6 channel discrete signals are input to this unit and are selected as the input source, this terminal outputs signals from the subwoofer channel.

REAR (SURROUND) OUTPUT terminals

These terminals are for rear channel line output. There is no connection to these terminals when you use the built-in amplifier.

However, if you drive rear speakers with an external stereo power amplifier, connect the input terminals of the external amplifier (MAIN IN or AUX terminals of a power amplifier or an integrated amplifier) to these terminals.

Note

Output level of signals from these terminals are adjusted by the use of **VOLUME** control on the front panel or **VOLUME** keys on the remote control transmitter.

IMPEDANCE SELECTOR switch

Be sure to switch this only when the power to this unit is not on. Select the position whose requirements your speaker system meets.

WARNING

Do not change the **IMPEDANCE SELECTOR** switch setting while the power to this unit is on, otherwise this unit may be damaged.

IF THIS UNIT FAILS TO TURN ON WHEN THE STANDBY/ON SWITCH IS PRESSED

The **IMPEDANCE SELECTOR** switch may not be set to either end closely. If so, set the switch to either end closely.

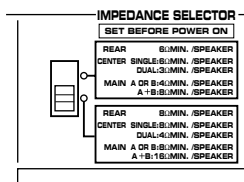

(Europe model)



(Upper position)

Rear: The impedance of each speaker must be 6Ω or higher.

Center: If you use one center speaker, the impedance of the speaker must be 6Ω or higher.
If you use two center speakers, the impedance of each speaker must be 3Ω or higher.

Main: If you use one pair of main speakers, the impedance of each speaker must be 4Ω or higher.
If you use two pairs of main speakers, the impedance of each speaker must be 8Ω or higher.



(Lower position)

Rear: The impedance of each speaker must be 8Ω or higher.

Center: If you use one center speaker, the impedance of the speaker must be 8Ω or higher.
If you use two center speakers, the impedance of each speaker must be 4Ω or higher.

Main: If you use one pair of main speakers, the impedance of each speaker must be 8Ω or higher.
If you use two pairs of main speakers, the impedance of each speaker must be 16Ω or higher.

ANTENNA CONNECTIONS

- Each antenna should be connected to the designated terminals correctly, referring to the following diagram.
- Both AM and FM indoor antennas are included with this unit. In general, these antennas will probably provide sufficient signal strength. Nevertheless, a properly installed outdoor antenna will give clearer reception than an indoor one. If you experience poor reception quality, an outdoor antenna may result in improvement.

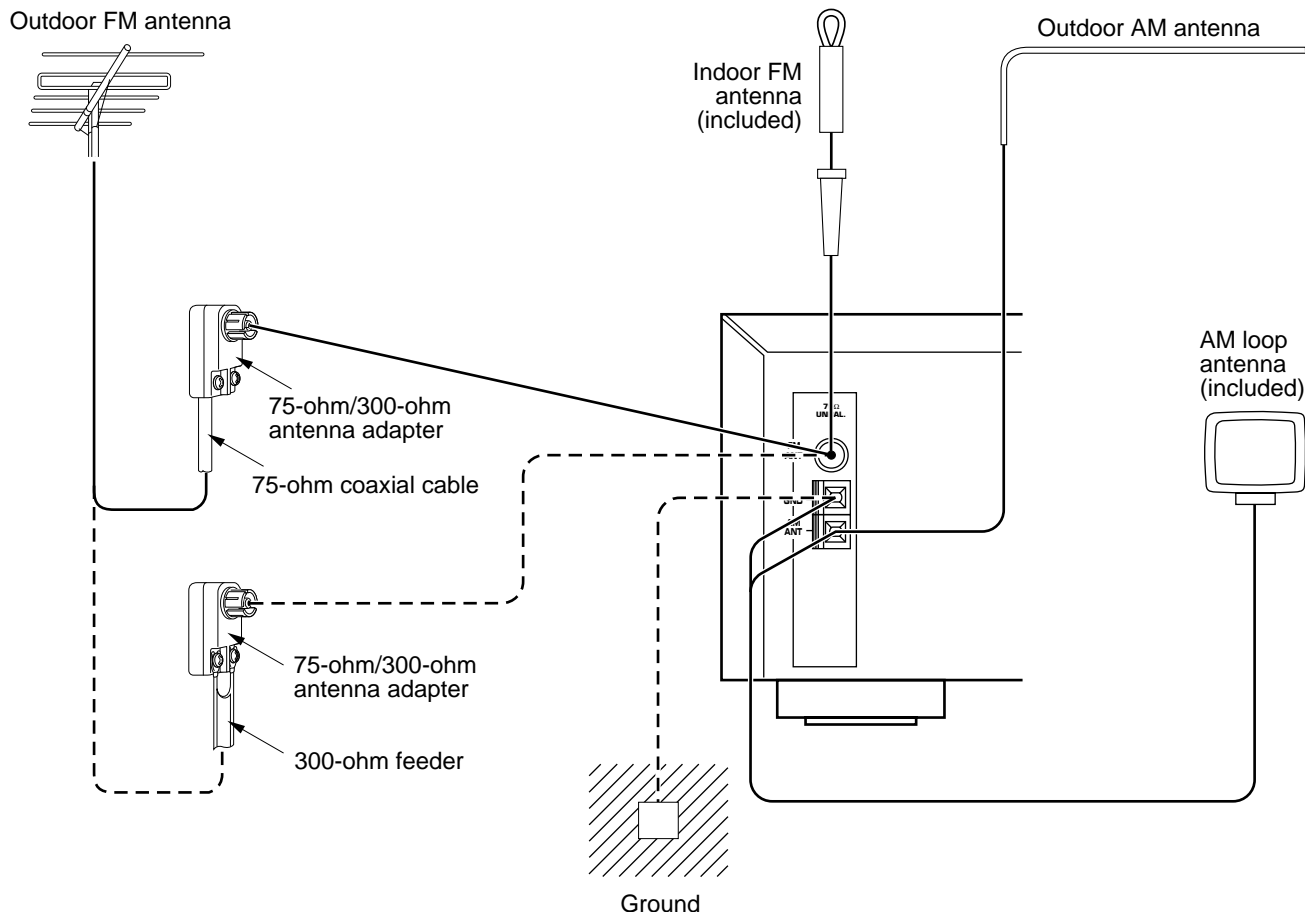

Connecting the AM loop antenna

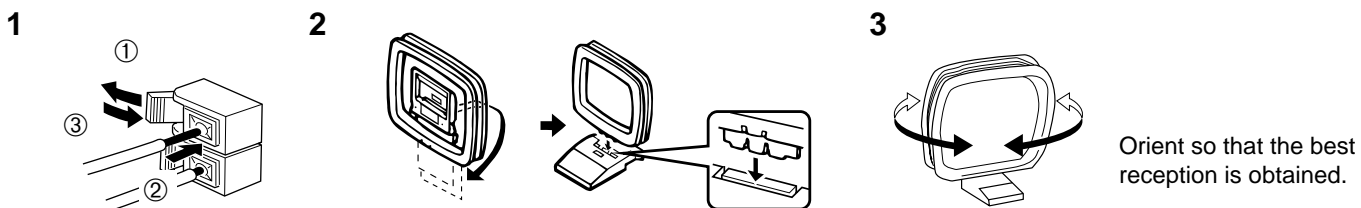

- * The AM loop antenna should be placed apart from the main unit. The antenna may be hung on a wall.
- * The AM loop antenna should be kept connected, even if an outdoor AM antenna is connected to this unit.

GND terminal

For maximum safety and minimum interference, connect the **GND** terminal to a good earth ground. A good earth ground is a metal stake driven into moist earth.

Notes

- When connecting the indoor FM antenna, insert its connector into the **FM ANT** terminal firmly.
- If you need an outdoor FM antenna to improve FM reception quality, either 300-ohm feeder or coaxial cable may be used. In locations troubled by electrical interference, coaxial cable is preferable.

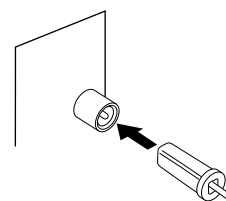

CONTROLS AND THEIR FUNCTIONS

FRONT PANEL

RX-V493RDS

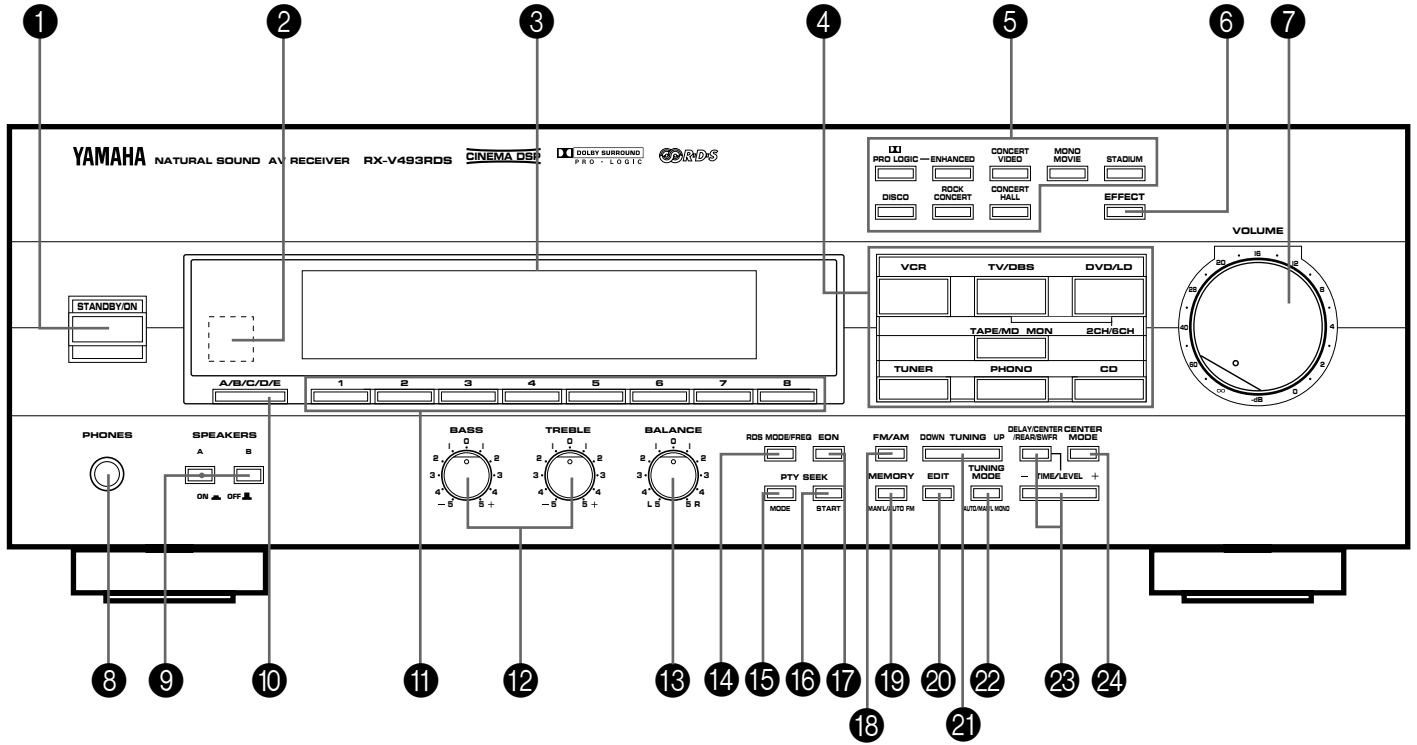

RX-V393RDS

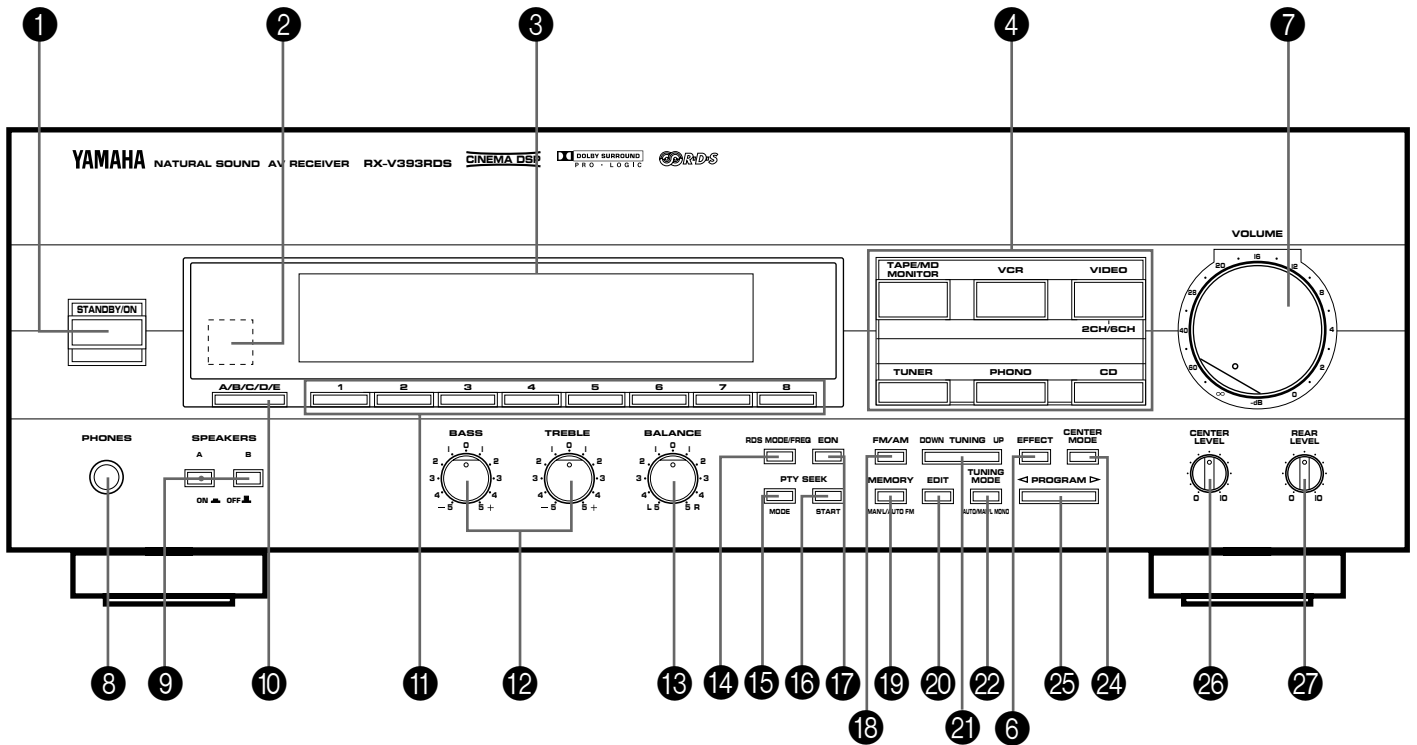

1 STANDBY/ON switch

Press this switch to turn the power to this unit on. Press it again to turn this unit into the standby mode.

Standby mode

In this state, this unit consumes a very small quantity of power to receive infrared-signals from the remote control transmitter.

2 Remote control sensor

Receives signals from the remote control transmitter.

3 Display panel

Shows various information. (For details, refer to page 19.)

4 Input selector buttons

Select a program source to listen to or watch. When a button is pressed, the name of selected source appears on the display.

RX-V493RDS only

When the **TV/DBS** or **DVD/LD** input source is selected, pressing the same button (TV/DBS or DVD/LD) switches the input signals between 2 channel stereo signals and 6 channel discrete signals. When switched to "6ch", discrete signals from the unit connected to the 6CH DISCRETE INPUT DVD/LD TV/DBS terminals of this unit are selected as the input signals.

RX-V393RDS only

When the **VIDEO** input source is selected, pressing the same button (VIDEO) switches the input signals between 2 channel stereo signals and 6 channel discrete signals. When switched to "6ch", discrete signals from the unit connected to the 6CH DISCRETE INPUT VIDEO terminals of this unit are selected as the input signals.

5 DSP program selector buttons

RX-V493RDS only

Select a DSP program. When a button is pressed, the name of selected program lights up on the display.

6 EFFECT button

Switches on/off the digital sound field processor (including the Dolby Pro Logic Surround decoder).

7 VOLUME control

Used to raise or lower the volume level.

8 PHONES jack

When you listen with headphones, connect the headphones to the **PHONES** jack. You can listen to the sound to be output from the main speakers through headphones.

When listening with headphones privately, set both the **SPEAKERS A** and **B** switches to the **OFF** position and switch off the digital sound field processor (so that no DSP program name is illuminated on the display) by pressing the **EFFECT** button.

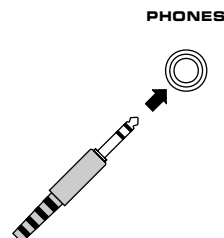

9 SPEAKERS switches

Set the switch **A** or **B** (or both **A** and **B**) for the main speaker system (connected to this unit) you will use to the **ON** position. Set the switch for the main speaker system you will not use to the **OFF** position.

10 A/B/C/D/E button

Press this button to select a desired group (A–E) of preset stations.

11 Preset station number selector buttons

Select a preset station number (1 to 8).

12 Tone controls

These controls are effective only for the sound from the main speakers.

BASS

Used to increase or decrease the low frequency response. The 0 position produces flat response.

TREBLE

Used to increase or decrease the high frequency response. The 0 position produces flat response.

13 BALANCE control

This control is effective only for the sound from the main speakers.

Adjusts the balance of the output volume to the left and right speakers to compensate for sound imbalance caused by speaker location or listening room conditions.

14 RDS MODE/FREQ button

When an RDS station is received, pressing this button changes the display mode into the PS mode, PTY mode, RT mode and/or CT mode (if the station employs those RDS data services), and frequency display in turn.

15 PTY SEEK MODE button

When this button is pressed, the unit turns into the PTY SEEK mode.

16 PTY SEEK START button

Press this button to begin searching for a station after the desired program type is selected in the PTY SEEK mode.

17 EON button

Press this button to select a desired program type (NEWS, INFO, AFFAIRS, SPORT) when you want to call a radio program of that program type automatically.

18 FM/AM button

Press this button to switch the reception band to FM or AM.

19 MEMORY (MAN'L/AUTO FM) button

When this button is pressed, the "MEMORY" indicator flashes for about 5 seconds. During this period, select a desired preset station number by pressing the corresponding preset station number selector button to enter the displayed station into the memory.

When this button is pressed and held for more than 3 seconds, the automatic preset tuning begins. (For details, refer to page 31.)

20 EDIT button

This button is used to exchange the places of two preset stations with each other.

21 TUNING DOWN/UP button

Used for tuning. Press the "UP" side to tune in to higher frequencies, and press the "DOWN" side to tune in to lower frequencies.

When this unit is in the PTY SEEK mode, pressing this switch changes the currently selected program type.

22 TUNING MODE (AUTO/MAN'L MONO) button

Press this button to switch the tuning mode to automatic or manual. To select the automatic tuning mode, press this button so that the "AUTO" indicator lights up on the display. To select the manual tuning mode, press this button so that the "AUTO" indicator goes off.

23 DELAY/CENTER/REAR/SWFR and TIME/LEVEL +/- buttons

RX-V493RDS only

Adjust the delay time (DELAY), the center channel output level (CENTER), the rear channel output level (REAR) and the output level to the SUBWOOFER OUTPUT terminal (SWFR). Select the item which you want to adjust by pressing the DELAY/CENTER/REAR/SWFR button and adjust its time or level by pressing the TIME/LEVEL +/- button.

24 CENTER MODE button

Selects a center channel output mode (NORMAL, WIDE or PHANTOM). (For details, refer to page 23.)

25 PROGRAM selector button

RX-V393RDS only

When the built-in digital sound field processor (including the Dolby Pro Logic Surround decoder) is on, this button changes the currently selected DSP program whenever the right or left side of this button is pressed.

26 CENTER LEVEL control

RX-V393RDS only

Adjusts the sound output level of the center speaker.

27 REAR LEVEL control

RX-V393RDS only

Adjusts the sound output level of the rear speakers.

DISPLAY PANEL

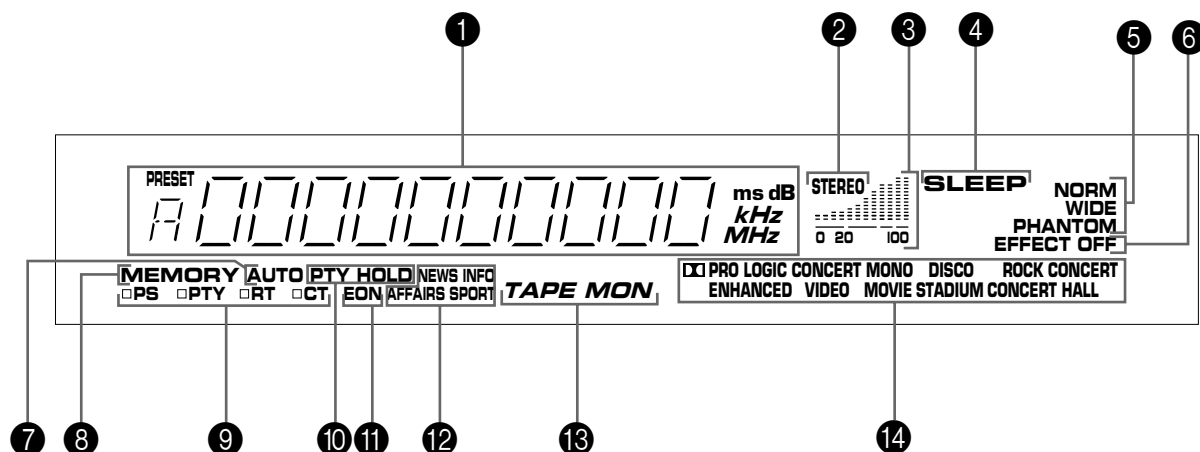

1 Multi-information display

Displays various information, for example station frequency, preset station number and name of selected input source.

2 STEREO indicator

Lights up when an FM stereo broadcast with sufficient signal strength is received.

3 Signal-level meter

Indicates the signal level of the received station. If multipath interference is detected, the indication decreases.

4 SLEEP indicator

Lights up while the built-in SLEEP timer is functioning.

5 Center channel mode indicators

The name of a selected center channel mode lights up only when a program which uses the Dolby Pro Logic Surround decoder is selected.

6 EFFECT OFF indicator

Lights up if neither the digital sound field processor nor the Dolby Pro Logic Surround decoder is on. In this state, sound output is 2-channel stereo.

7 AUTO indicator

Lights up when this unit is in the automatic tuning mode.

8 MEMORY indicator

When the **MEMORY** button is pressed, this indicator flashes for about 5 seconds. During this period, the displayed station can be programmed to the memory by using the **A/B/C/D/E** button and the preset station number selector buttons.

9 RDS mode indicators

The name(s) of RDS mode(s) employed by the currently received RDS station light(s) up. Illumination of the indicator on the head of a name shows that the corresponding RDS mode is now selected.

10 PTY HOLD indicator

Lights up while the search is performed in the PTY SEEK mode.

11 EON indicator

Lights up when an RDS station that employs the EON data service is received.

12 Program type name indicators

The name selected in the EON mode lights up.

13 TAPE MON indicator

Lights up when the tape deck (or MD recorder etc.) is selected as the input source by pressing the **TAPE/MD MONITOR (MON)** button.

14 DSP program indicators

The name of a selected DSP program lights up when the built-in digital sound field processor and/or the Dolby Pro Logic Surround decoder is on.

REMOTE CONTROL TRANSMITTER

The remote control transmitter provided with this unit is designed to control all the most commonly used functions of this unit. If the CD player and tape deck connected to this unit are YAMAHA components designed for remote control compatibility, then this remote control transmitter will also control various functions of each component.

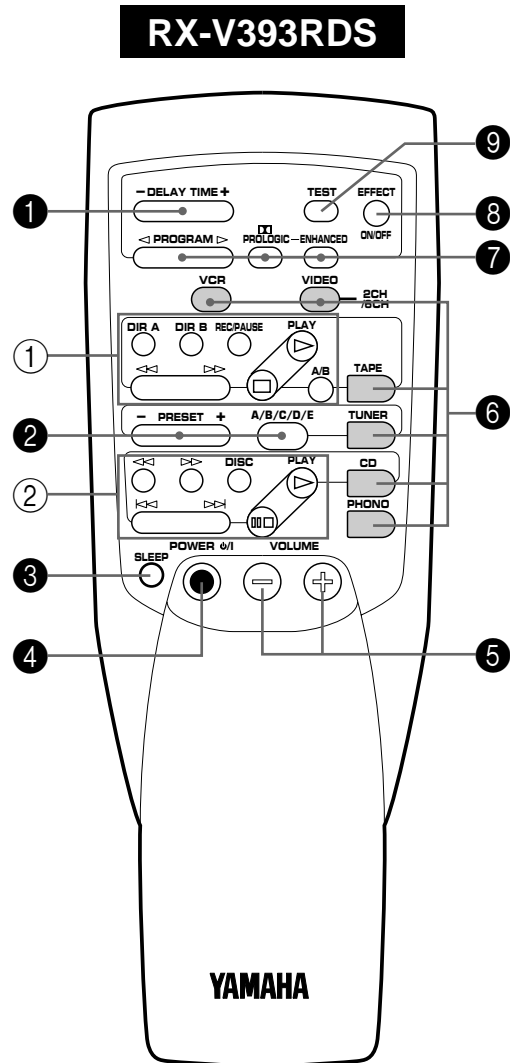
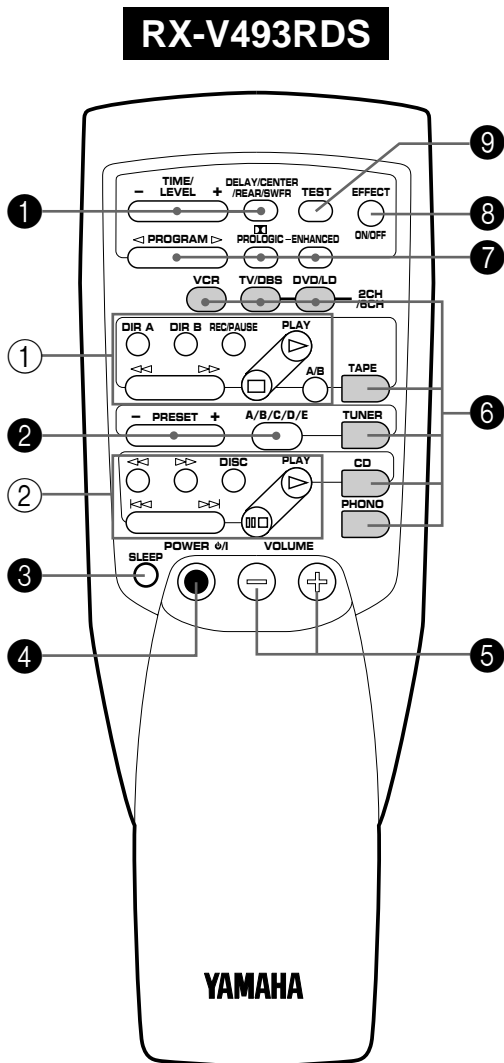

For Control of This Unit

1 DELAY/CENTER/REAR/SWFR and TIME/LEVEL +/- keys

RX-V493RDS only

Adjust the delay time (DELAY), the center channel output level (CENTER), the rear channel output level (REAR) and the output level to the SUBWOOFER OUTPUT terminal (SWFR). Select the item which you want to adjust by pressing the DELAY/CENTER/REAR/SWFR key and adjust its time or level by pressing the TIME/LEVEL +/- key. (For details, refer to page 28, 40 and 41.)

DELAY TIME +/- key

RX-V393RDS only

Adjusts the delay time, or the time difference between the beginning of source sound and the beginning of effect sound. (For details, refer to page 41.)

2 Tuner keys

Control tuner.

+: Selects higher preset station number.

-: Selects lower preset station number.

A/B/C/D/E: Selects the group (A – E) of preset station numbers.

3 SLEEP timer key

This key is used to turn the built-in SLEEP timer on and off, and to set the SLEEP time. (For details, refer to page 42.)

4 POWER ϕ /I key

Turns the power to this unit on and turns this unit into the standby mode alternately.

5 VOLUME +/- keys

Turn the volume level up/down.

6 Input selector keys

Select input source.

RX-V493RDS only

When the TV/DBS or DVD/LD input source is selected, pressing the same key (TV/DBS or DVD/LD) switches the input signals between 2 channel stereo signals and 6 channel discrete signals. When switched to "6ch", discrete signals from the unit connected to the 6CH DISCRETE INPUT DVD/LD TV/DBS terminals of this unit are selected as the input signals.

RX-V393RDS only

When the VIDEO input source is selected, pressing the same key (VIDEO) switches the input signals between 2 channel stereo signals and 6 channel discrete signals. When switched to "6ch", discrete signals from the unit connected to the 6CH DISCRETE INPUT VIDEO terminals of this unit are selected as the input signals.

7 Program selector keys

PROGRAM:

When the built-in digital sound field processor (including the Dolby Pro Logic Surround decoder) is on, this key changes the currently selected DSP program whenever the right or left side of this key is pressed.

PROLOGIC:

Directly selects the PRO LOGIC program.

ENHANCED:

Directly selects the PRO LOGIC ENHANCED program.

8 EFFECT ON/OFF key

Switches on/off the digital sound field processor (including the Dolby Pro Logic Surround decoder).

9 TEST key

Used for speaker balance adjustment. (For details, refer to page 22–24.)

For Other Component Control

Identify the remote control transmitter keys with your component's keys. If these keys are identical, their functions will be the same. On each key function, refer to the corresponding instruction on your component's manual.

1 Tape deck keys

Control tape deck.

* DIR A, B and A/B are applicable only to double cassette tape deck.

* For a single cassette deck with automatic reverse function, pressing DIR A will reverse the direction of tape running.

2 CD player keys

Control compact disc player.

* DISC is applicable only to compact disc changer.

SPEAKER BALANCE ADJUSTMENT

This procedure lets you adjust the sound output level balance between the main, center, and rear speakers using the built-in test tone generator. When this adjustment is performed, the sound output level heard at the listening position will be the same from each speaker. This is important for the best performance of the digital sound field processor and the Dolby Pro Logic Surround decoder.

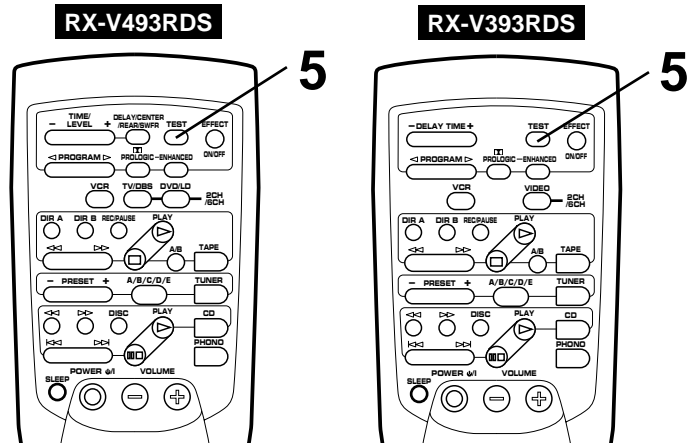
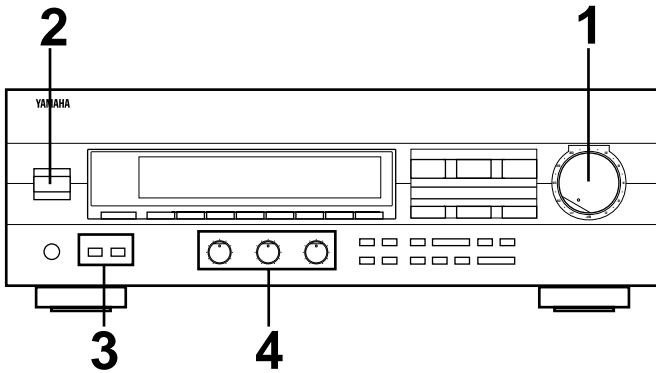

1

Set to the "∞" position.

2 Turn the power on.

3 Select the main speakers to be used.

SPEAKERS

A B

* If you use two main speaker systems, press both the A and B switches.

4

Set to the "0" position.

5

TEST LEFT

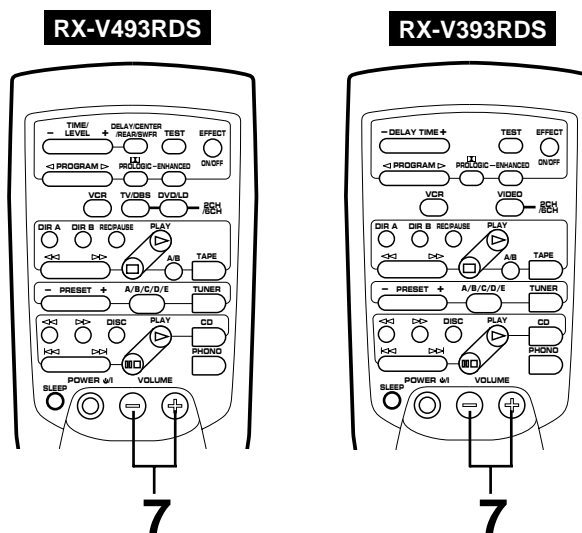
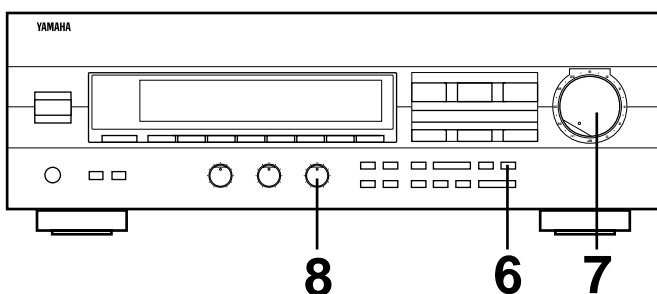

6 Select the center channel output mode suitable for your speaker configuration. (Refer to "SPEAKER CONFIGURATION" on page 7.)

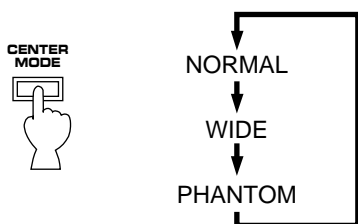

On the feature of each mode, refer to the "Note" shown below.

Note

In step 6, when you select a center channel output mode, note the following.

For 5 speaker configuration)

NORMAL: Select this mode when you use a center speaker that is smaller than the main speakers. In this mode, the bass tone will be output from the main speakers.

WIDE: Select this mode when you use the center speaker approximately same sized as the main speakers.

For 4 speaker configuration)

PHANTOM: Select this mode when you do not use the center speaker. The center sound will be output from the left and right main speakers.

7 Turn up the volume.

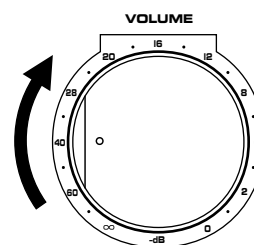

You will hear a test tone (like pink noise) from the left main speaker, then the center speaker, then the right main speaker, and then the rear speakers, for about two seconds each. The display changes as shown below.

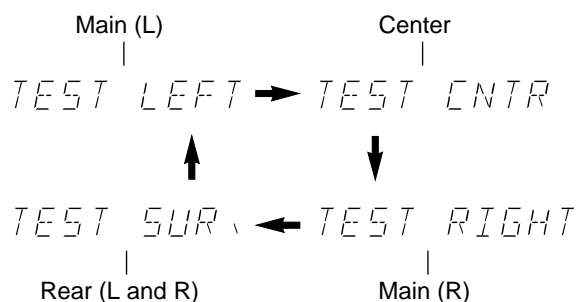

* The test tone from the left rear speaker and the right rear speaker will be heard at the same time.

8 Adjust the **BALANCE** control so that the effect sound output level of the left main speaker and the right main speaker are the same.



CONTINUED

RX-V493RDS

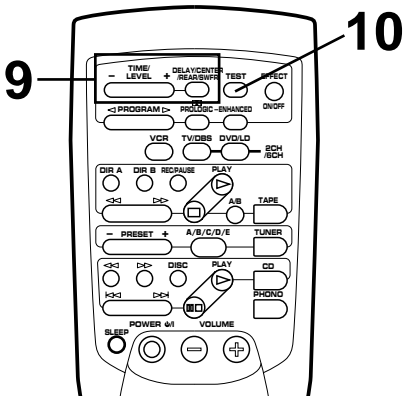

RX-V393RDS

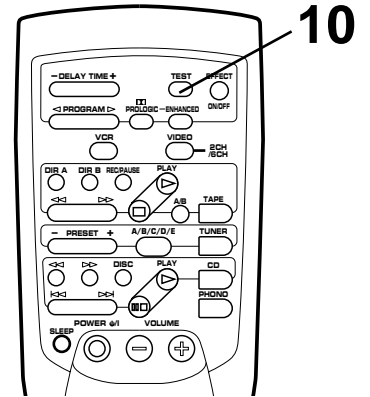
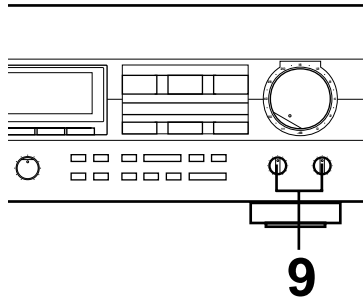

9 Adjust the sound output levels of the center speaker and the rear speakers so that they become almost as same as that of the main speakers.

RX-V493RDS

Make the adjustment of each speaker output level at your listening position with the remote control transmitter.

- a) Press once or more so that "CENTER" or "REAR" appears on the display.
 - * Select "CENTER" to adjust the output level of the center speaker, and select "REAR" to adjust the output level of the rear speakers.



- b) Adjust its level.
 - * Pressing the + side raises and the - side lowers the level.

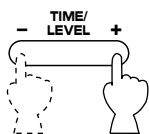

RX-V393RDS

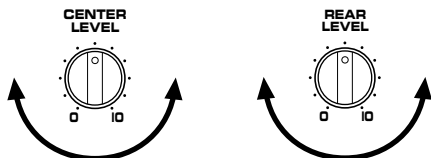

10 Cancel the test tone.



TEST LEFT
|
Disappears.

Notes

- Once you have completed these adjustments, you can adjust whole sound level on your audio system by using the **VOLUME** control (or the **VOLUME** keys on the remote control transmitter) only.
- If you use external power amplifiers, you may also use their volume controls to achieve proper balance.
- If there is insufficient sound output from the center and rear speakers, you may decrease the main speaker output level by setting the **MAIN LEVEL** switch on the rear panel to "-10 dB".
- **RX-V493RDS only**

In step 9, if the center channel mode is in the "PHANTOM" position, the sound output level of the center speaker cannot be adjusted. This is because in this mode, the center sound is automatically output from the left and right main speakers.

BASIC OPERATIONS

TO PLAY A SOURCE

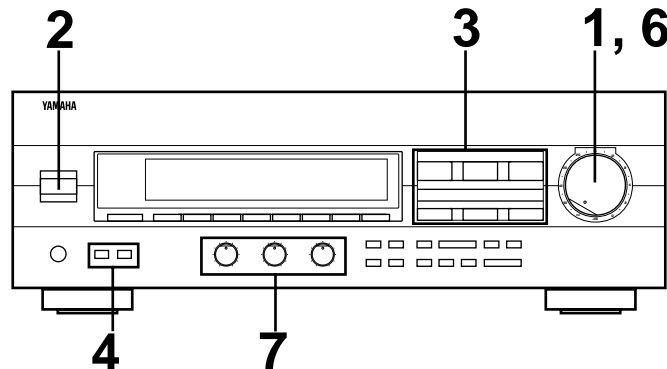

1

Set to the "∞" position.

2 Turn the power on.

3 Select the desired input source by using the input selector buttons.
(For video sources, turn the TV/monitor ON.)

* The name of the selected input source will appear on the display.

4 Select the main speakers to be used.

* If you use two main speaker systems, press both the A and B switches.

5 Play the source. (For detailed information on the tuning operation, refer to page 29.)

6

Adjust to the desired output level.

7 If desired, adjust the **BASS**, **TREBLE** and **BALANCE** controls (refer to page 28), and use the digital sound field processor. (Refer to page 39.)

Notes on using the input selector buttons

- Note that pressing on each input selector button selects the source which is connected to the corresponding input terminals on the rear panel.
- The selection of **TAPE/MD MONITOR (MON)** cannot be canceled by pressing another input selector button. To cancel it, press **TAPE/MD MONITOR (MON)** again so that the "TAPE MON" indicator disappears from the display. When you select a button other than **TAPE/MD MONITOR (MON)**, make sure that the "TAPE MON" indicator is not illuminated on the display.
- If you select the input selector button for a video source without canceling the selection of **TAPE/MD MONITOR (MON)**, the playback result will be the video image from the video source and the sound from the audio tape (or MD etc.).
- Once you play a video source, its video image will not be interrupted even if the input selector button for an audio source is selected.

When you finish using this unit

Press the **STANDBY/ON** switch on the front panel again or the **POWER** key on the remote control transmitter to turn this unit into the standby mode.

To listen to a decoded source using Dolby Digital (AC-3) or DTS by reproducing the signals input to the 6CH DISCRETE INPUT terminals of this unit.

In step 3, press the button (shown below) once or more so that "6ch" appears on the display.

Discrete signals from the unit connected to the 6CH DISCRETE INPUT terminals of this unit are selected as the input signals.

RX-V493RDS

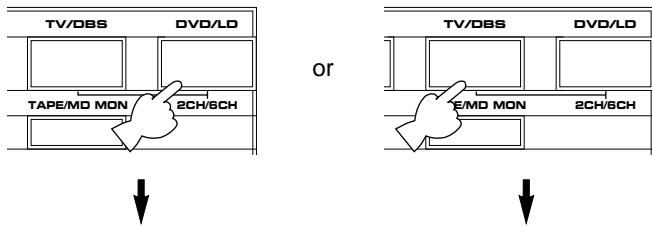

TV/DBS 6ch TV/DBS 6ch

RX-V393RDS

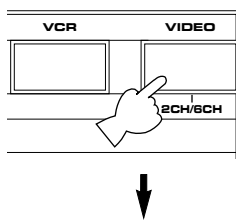

VIDEO 6ch

To cancel listening to a decoded source using Dolby Digital (AC-3) or DTS

Press the same button again or select another input source.

Note for reproducing discrete signals with Dolby Digital (AC-3) or DTS decoded:

1. Your speaker system must include a center speaker.
 2. Your speaker system must include a subwoofer.
 - * Connect a subwoofer which has a built-in amplifier to the SUBWOOFER OUTPUT terminal of this unit.
 - * You can do without using a subwoofer. If you do so, you should make a setting for distributing signals at the LFE channel to the right and left MAIN output terminals on the Dolby Digital (AC-3) Decoder etc.
- For details, refer to the owner's manual for the Dolby Digital (AC-3) Decoder etc.

Notes

- When you switch to the "6ch" mode, the built-in Digital Sound Field processor will not work and adjustment of delay time cannot be made.
- Switching this unit to the "6ch" mode will input no signal to this unit if there is no connection to the 6CH DISCRETE INPUT terminals of this unit.

TO RECORD A SOURCE TO TAPE (OR MD)

RX-V493RDS

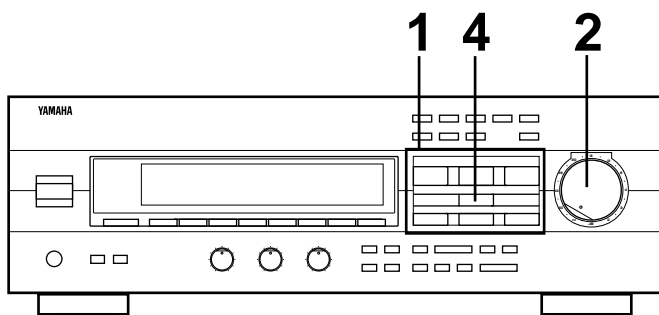

RX-V393RDS

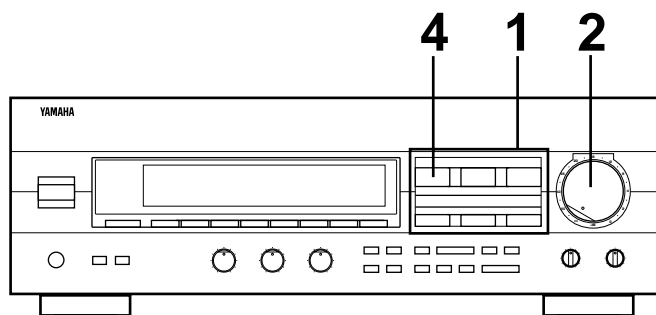

- 1** Select the source to be recorded.

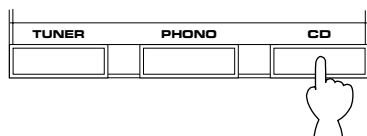

- 2** Play the source and then turn the **VOLUME** control up to confirm the input source. (For detailed information on the tuning operations, refer to the page 29.)

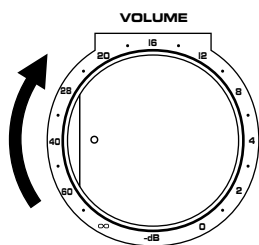

- 3** Begin recording on the tape deck (or MD recorder etc.) or VCR connected to this unit.

- 4** If the tape deck (or MD recorder etc.) is used for recording, you can monitor the sounds being recorded by pressing **TAPE/MD MONITOR (MON)** so that the "TAPE MON" indicator lights up on the display.

RX-V493RDS

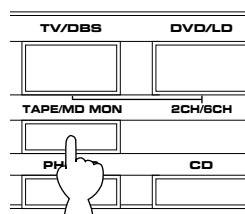

RX-V393RDS

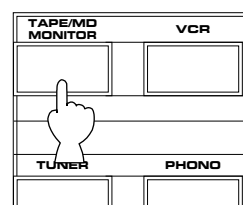

Notes

- The settings of DSP and the **VOLUME, BASS, TREBLE** and **BALANCE** controls have no effect on the material being recorded.
- In step 1, do not make an input source selection so that "6ch" appears on the display. Signals input to this unit's 6CH DISCRETE INPUT terminals cannot be recorded by a tape deck, MD recorder or VCR.

Selecting the SPEAKER system

Because one or two speaker systems (as main speakers) can be connected to this unit, the **SPEAKERS** switches allow you to select speaker system **A** or **B**, or both at once.

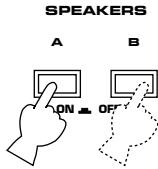

Adjusting the BALANCE control

Adjust the balance of the output volume to the left and right speakers to compensate for sound imbalance caused by speaker location or listening room conditions.



Note

This control is effective only for the sound from the main speakers.

Adjusting the BASS and TREBLE controls

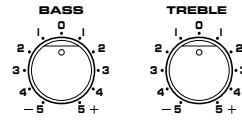

BASS : Turn this clockwise to increase (or counter-clockwise to decrease) the low frequency response.

TREBLE : Turn this clockwise to increase (or counter-clockwise to decrease) the high frequency response.

Note

These controls are effective only for the sound from the main speakers.

Adjusting the subwoofer output level **RX-V493RDS only**

If your audio system includes a subwoofer, and an amplifier driving the subwoofer (or a subwoofer system including an amplifier) is connected to the SUBWOOFER OUTPUT terminal on the rear of this unit, you can adjust the subwoofer output level on this unit.

- 1 Press once or more so that "SWFR" appears on the display.

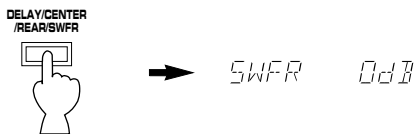

- 2 By continuously pressing the "+" or "-" side of the **TIME/LEVEL** button, the level value changes continuously. If you feel that bass tone is insufficient, increase the level, and if you feel that bass tone is overly emphasized, decrease the level.

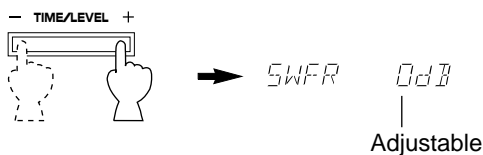

Control range: MIN, -20 to 0 dB

TUNING OPERATIONS

Normally, if station signals are strong and there is no interference, quick automatic-search tuning (AUTOMATIC TUNING) is possible. However, if signals of the station you want to select are weak, you must tune to it manually (MANUAL TUNING).

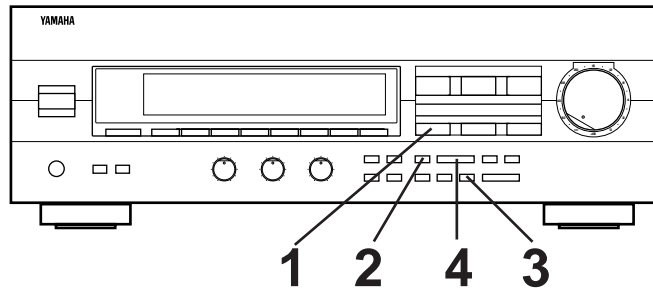

AUTOMATIC TUNING

- 1** Select "TUNER" as the input source.
- 2** Select the reception band (FM or AM) confirming it on the display.
- 3**
- 4** To tune to a higher frequency, press the right side once. To tune to a lower frequency, press the left side once.

* If the station where tuning search stops is not the desired one, press again.
 * If the tuning search does not stop at the desired station (because the signals of the station are weak), change to the MANUAL TUNING method.

MANUAL TUNING

- 1** Select "TUNER" as the input source.
- 2** Select the reception band (FM or AM) confirming it on the display.
- 3**
- 4** Tune to a desired station manually.

* To continue tuning search, press and hold the button.

Notes

- If you tune to an FM station manually, it is received in monaural mode automatically to increase the signal quality.
- When tuned in to a station, the frequency of the received station is shown on the display. If an RDS station that employs PS data service is received, the frequency is then replaced by the station name. Refer to page 35 for details.

PRESET TUNING

MANUAL PRESET TUNING

This unit can store station frequencies selected by tuning operation. With this function, you can recall any desired station by only selecting the preset station number where it is stored. Up to 40 stations (8 stations x 5 groups) can be stored.

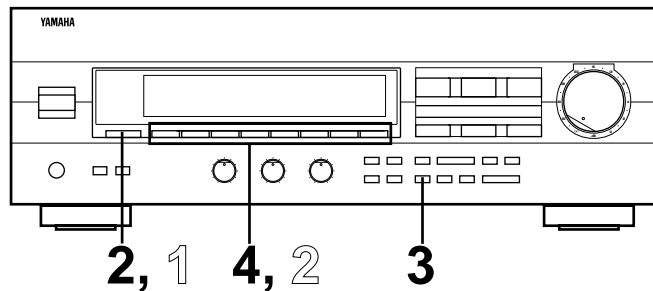

To store stations

- 1** Tune to a desired station.
(Refer to the previous page for tuning procedure.)
- 2** Select a desired group (A – E) of preset stations confirming it on the display.
- 3**

Flashes on and off for about 5 seconds.
- 4** Select a preset station number where you want to program the station before the “MEMORY” indicator goes off from the display.

Shows the displayed station has been programmed to A1.

* In the same way, program other stations to A2, A3 ... A8.
* You can program more stations to preset station numbers on other groups in the same way by selecting other groups in step 2.

To recall a preset station

- 1** Select the group of preset stations.
- 2** Select the preset station number.

Notes

- A new setting can be programmed in place of the former one.
- For presets, the setting of the reception mode (stereo or monaural) is stored along with the station frequency.

Memory back-up

The memory back-up circuit prevents the programmed data from being lost even if this unit is turned into the standby mode or the power plug is disconnected from the AC outlet or the power is cut due to temporary power failure. If, however, the power is cut for more than one week, the memory may be erased. If so, it can be re-programmed by simply following the PRESET TUNING steps.

AUTOMATIC PRESET TUNING

You can also make use of an automatic preset tuning function for RDS stations only. By this function, this unit performs automatic tuning and stores RDS stations with strong signals sequentially. Up to 40 stations are stored automatically in the same way as in the manual preset tuning method on page 30.

* Refer to page 33–37 for details on RDS stations.

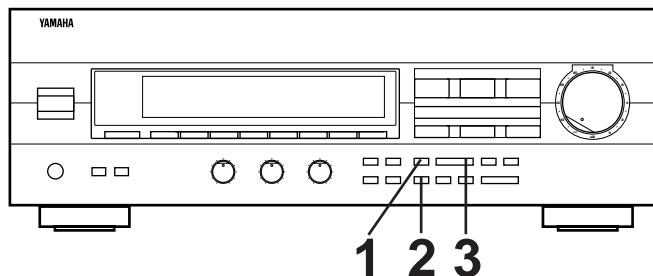

To store stations

1	<p>FM/AM</p>
2	<p>MEMORY</p> <p>MANUAL PROGRAM</p> <p>Press and hold for more than 3 seconds.</p> <p>Flashes.</p>
3	<p>DOWN TUNING UP</p> <p>To tune to higher frequencies, press right side once. To tune to lower frequencies, press left side once. * If the TUNING button is not pressed, in a while, the automatic preset tuning begins automatically toward higher frequencies.</p> <p>The automatic preset tuning begins from the frequency currently displayed. Received stations are programmed to A1, A2 ... A8 sequentially. * If more than 8 stations are received, they are also programmed to the preset station numbers on other groups (B, C, D and E) in that order.</p>

When the automatic preset tuning is finished

The display shows the frequency of the last preset station. Check the contents and the number of preset stations by following the procedure of the section "To recall a preset station" on page 30.

To recall a preset station

Simply follow the procedure of the section "To recall a preset station" on page 30.

* A recalled station is shown by the frequency or station name on the display.

Notes

- You can replace a preset station by another FM or AM station manually by simply following the procedure of the section "To store stations" on page 30.
 - The automatic preset tuning search will be performed through all RDS network frequencies until stations are stored up to E8. If the number of received stations is not enough to be stored up to E8, the search is finished automatically after searching all frequencies.
 - With this function, only RDS stations with sufficient signal strength are stored automatically. If the station you want to program is weak in signal strength, tune to it in monaural manually and program it by following the procedure of the section "To store stations" on page 30.
- * There may be a case that this function cannot receive a station which could be received by the automatic tuning method. This is because this function receives a large volume of PI (Program Identification) data along with the station.

If you want to store the first station received by the automatic preset tuning to a desired preset station number.

If, for example, you want to store the first received station to C5, select "C5" by using the **A/B/C/D/E** button and the preset station number selector buttons after pressing the **MEMORY** button in step 2. Then press the **TUNING** button. The first received station is stored to C5, and next stations to C6, C7 ... sequentially.

If stations are stored up to E8, the automatic preset tuning is finished automatically.

EXCHANGING PRESET STATIONS

You can exchange the places of two preset stations with each other as shown below.

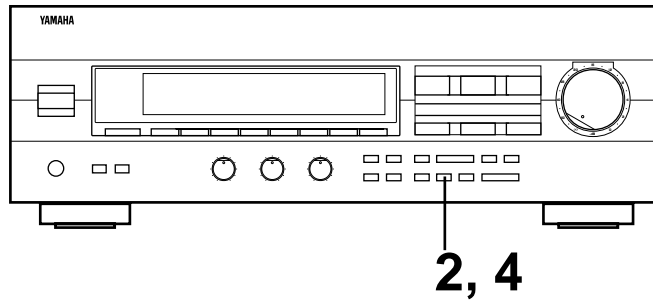

Example)

If you want to shift the preset station on E1 to A5, and vice versa.

1	Recall the preset station on E1 (by following the method of "To recall a preset station" on page 30).
2	<p>Flashes.</p>
3	Next, recall the preset station on A5 by following the same method with step 1.
	<p>Flashes.</p>

4	<p>Flashes.</p>
	<p>Flashes.</p>
	<p>Shows the exchange of stations is completed.</p>

In areas where RDS broadcasts cannot be received, the RDS broadcast functions do not operate. (The procedures from page 33 to page 37 are not necessary.)

RECEIVING RDS STATIONS

RDS (Radio Data System) is a data transmission system gradually being introduced by FM stations in many countries. Stations using this system transmit an inaudible stream of data in addition to the normal radio signal.

RDS data contains various information, such as PI (Program Identification), PS (Program Service name), PTY (Program Type), RT (Radio Text), CT (Clock Time), EON (Enhanced Other Networks), etc.

RDS function is carried out among the network stations.

* This unit utilizes PI, PS, PTY, RT, CT and EON to receive RDS broadcast stations.

Displaying RDS data

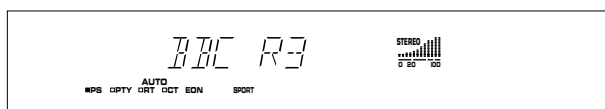

This unit can be turned into the following five modes to display RDS data.

PS (Program Service name) mode:

Displays the name of the RDS station now being received instead of the frequency.

PTY (Program Type) mode:

Displays the type of the program on the RDS station now being received. There are 15 program types to classify RDS stations. Refer to the next page for details.

RT (Radio Text) mode:

Displays information about the program (such as title of the song, name of the singer, etc.) on the RDS station now being received.

CT (Clock Time) mode:

Displays current time. This signal comes from the RDS station now being received.

EON (Enhanced Other Networks) mode:

Automatically receives a program of the designated program type when its broadcast starts, in place of the program now being received. When the broadcast of the called program ends, the previously received program (or another program on the same station) is recalled.

Program types in the PTY mode

NEWS

News:

Short accounts of facts, events and publicly expressed views, reportage and actuality.

AFFAIRS

Current affairs:

Topical program expanding or enlarging upon the news, generally in different presentation style or concept, including documentary debate, or analysis.

INFO

Information:

Program whose purpose is to impart advice in the widest sense, including meteorological reports and forecasts, consumer affairs, medical help, etc.

SPORT

Sport:

Program concerned with any aspect of sport.

EDUCATE

Education:

Program intended primarily to educate, of which the formal element is fundamental.

DRAMA

Drama:

All radio plays and serials.

CULTURE

Culture:

Programs concerned with any aspect of national or regional culture, including religious affairs, philosophy, social science, language, theatre, etc.

SCIENCE

Science:

Programs about the natural sciences and technology.

VARIED

Varied:

Used for mainly speech-based programs usually of light-entertainment nature, not covered by above categories. Examples are: quizzes, panel games, personality interviews, comedy and satire.

POP M

Pop:

Commercial music, which would generally be considered to be of current popular appeal, often featuring in current or recent record sales charts.

ROCK M

Rock:

Contemporary modern music, usually written and performed by young musicians.

M.O.R. M

M.O.R.:

(Middle of the Road Music). Common term to describe music considered to be "easy-listening", as opposed to Pop, Rock or Classical. Music in this category is often but not always, vocal, and usually of short duration (<5 min.)

LIGHT M

Light classics:

Classical Musical for general, rather than specialist appreciation. Examples of music in this category are instrumental music, and vocal or choral works.

CLASSICS

Serious classics:

Performances of major orchestral works, symphonies, chamber music etc., and including Grand Opera.

OTHER M

Other music:

Musical styles not fitting into any of the above categories. Particularly used for specialist music, of which Jazz, Rhythm & Blues, Folk, Country, and Reggae are examples.

Changing the RDS modes

When an RDS station is received, "PS", "PTY", "RT" and/or "CT" that correspond to the RDS data services employed by the station light up on the display. By pressing the **RDS MODE/FREQ** button once or more, you can change the display mode among the RDS modes employed by the received station in the order shown below. (The RDS mode not employed by the station cannot be selected.) Illumination of the indicator on the head of a name of RDS mode shows that the corresponding RDS mode is now selected.

* When an RDS station is received, do not press the **RDS MODE/FREQ** button until one or some names of RDS modes light up on the display. If the button is pressed before one or some names light up on the display, the mode cannot be changed. This is because the unit has not received all of the RDS data on the station yet.

* If no name of RDS mode lights up on the display, the mode cannot be changed.

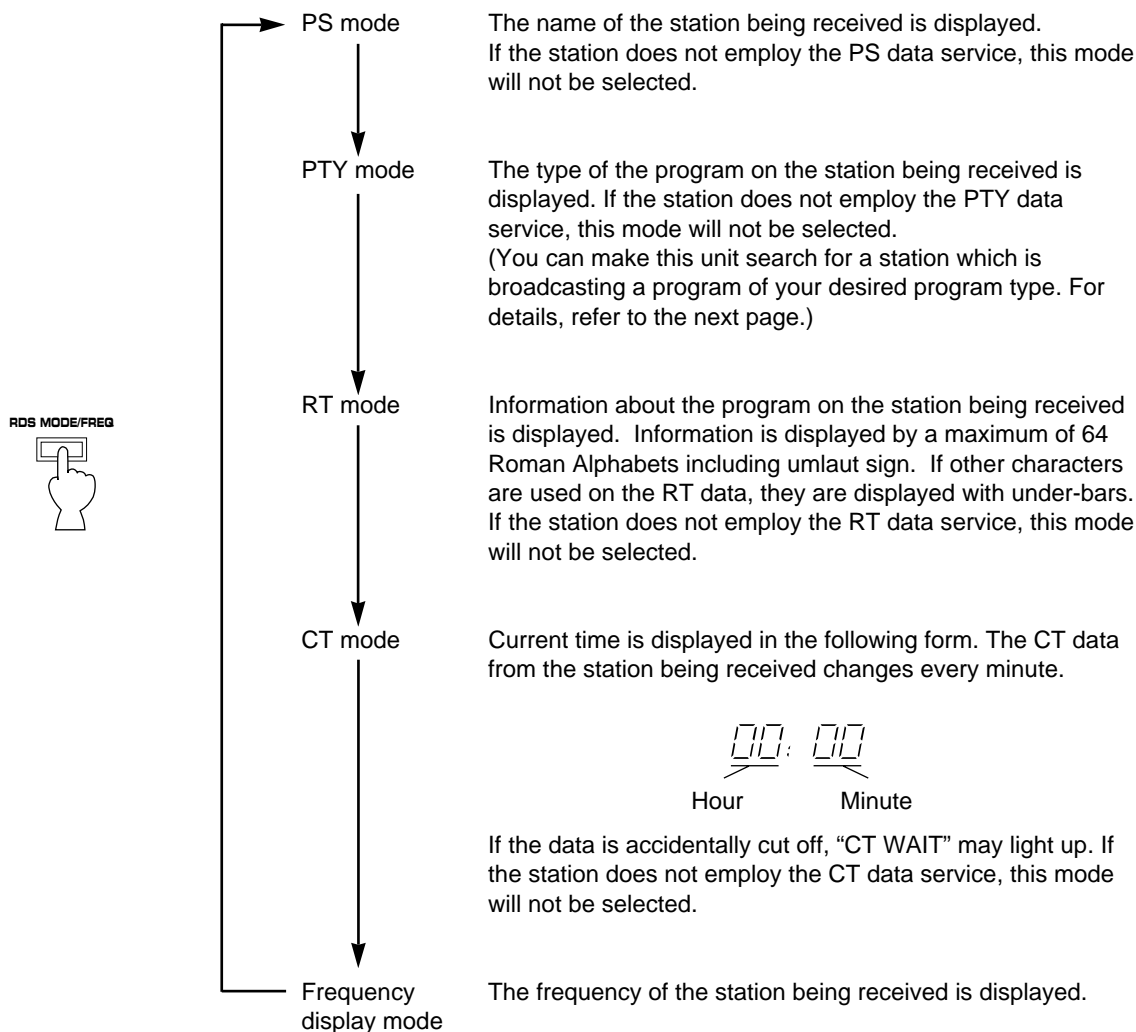

Notes

- RDS data service cannot be utilized by this unit if the received signal is not strong enough. Especially, the RT (Radio Text mode) needs much data to be received, so it may occur that RT mode cannot be displayed even if other RDS modes (PS, PTY, etc.) are displayed.
- There may be a case that RDS data reception is not possible due to poor reception conditions. If so, press the **TUNING MODE** button so that the "AUTO" indicator goes off from the display. Though the reception mode is changed to monaural by this operation, when you change the display to an RDS mode, RDS data may be displayed.
- If the signal strength gets weakened by external interference during receiving an RDS station, the RDS data service may be cut off suddenly and "...WAIT" will light up on the display.

Calling a program of your desired program type from among preset RDS stations (PTY SEEK)

By designating a program type, the unit automatically searches all preset stations for an RDS station which broadcasts a program of that program type.

* There are 15 program types to classify RDS stations. For details, refer to page 34.

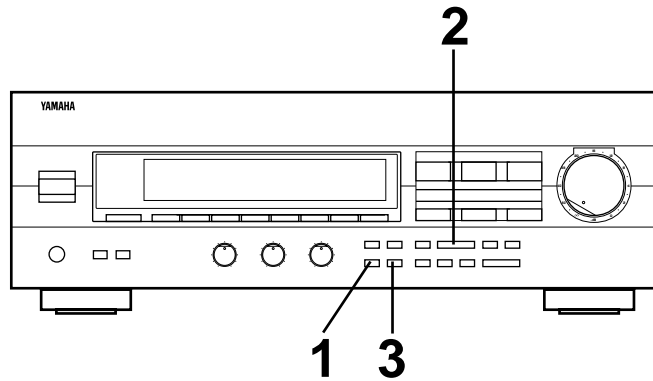

1 Turn the unit into the PTY SEEK mode.

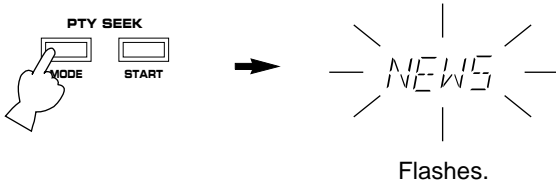

* The program type of the station now being received or "NEWS" flashes on the display.

2 Select the desired program type.

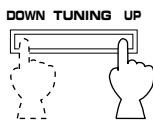

3 Begin searching all preset RDS stations.

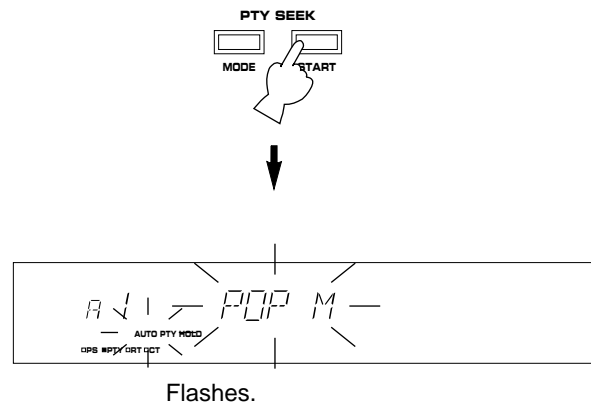

* The "PTY HOLD" indicator lights up on the display.

- If a station which broadcasts a program of the program type is found, the unit stops at the station and the program type lights up.
- If the called station is not the desired one, press the **PTY SEEK START** button once more. The unit begins searching for another station which broadcasts a program of the same program type.
- To stop the search, press the **PTY SEEK START** button once more.

To cancel this function

If the **PTY SEEK MODE** button is pressed once more, the PTY SEEK mode is canceled.

Making this unit call a program of your desired program type automatically when its broadcast starts

This function uses the EON (Enhanced Other Networks) data service on the RDS station network.

By only selecting a desired program type (NEWS, INFO, AFFAIRS or SPORT), this unit automatically searches all preset RDS stations for a station that broadcasts a program of that program type in the background, and, if found, receives a program when its broadcast starts in place of the program now being received.

* This function can be used only when an RDS station that employs the EON data service is received. (When such a station is received, the "EON" indicator lights up on the display.)

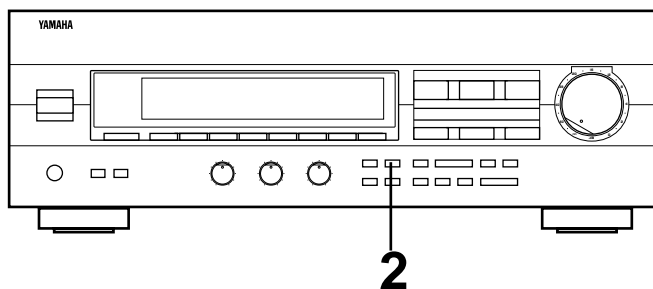

- 1** Make sure that the "EON" indicator is illuminated on the display.

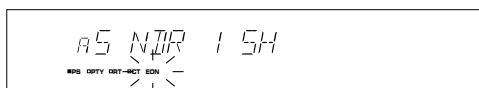

* If the "EON" indicator is not illuminated on the display, receive an (or another) RDS station so that the "EON" indicator lights up on the display.

- 2** Select a desired program type, NEWS, INFO, AFFAIRS or SPORT.

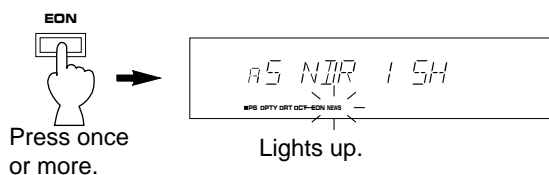

The search is performed among all preset RDS stations in the background. If a program is found, the program is automatically received when its broadcast starts.

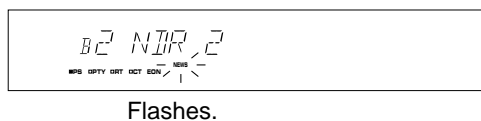

- 3** When the broadcast of the called program ends, the previously received program (or another program on the same station) is recalled.

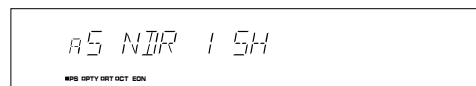

To cancel this function

Press the **EON** button once or more, so that no program type name lights up on the display.

USING DIGITAL SOUND FIELD PROCESSOR (DSP)

This unit incorporates a sophisticated, multi-program digital sound field processor. The processor allows you to electronically expand and change the shape of the audio sound field from both audio and video sources, creating a theater-like experience in your listening room. You can create an excellent audio sound field by selecting a suitable sound field program (this will, of course, depend on what you will be listening to), and adding desired adjustments.

In addition, this unit incorporates a Dolby Pro Logic Surround decoder for multi-channel sound reproduction of sources encoded with Dolby Surround. The operation of the Dolby Pro Logic Surround decoder can be controlled by selecting a corresponding DSP program including a combined operation of the Yamaha DSP and the Dolby Pro Logic Surround.

Brief Overview of Digital Sound Field Programs

The following list gives you a brief description of the sound fields produced by each of the DSP programs. Keep in mind that most of these are precise digital recreations of actual acoustic environments. The data for these sound fields was recorded at actual locations using sophisticated sound field measurement equipment.

Note
The channel level balance between the left and right rear effect speakers may vary depending on the sound field you are listening to. This is due to the fact that most of these sound field recreations are actual acoustic environments.

PROGRAM	FEATURE
<input checked="" type="checkbox"/> PRO LOGIC	This program is used for playback of sources encoded with Dolby Surround. The application of a sophisticated digital signal processing system reduces crosstalk and directs or steers the sound source more smoothly and precisely, as compared to conventional types.
<input checked="" type="checkbox"/> PRO LOGIC ENHANCED	This program is also used for playback of sources encoded with Dolby Surround. Enhancing the "Normal" Dolby Pro Logic, the DSP technology simulates the multi-surround speaker systems of a 35 mm movie theater. This effect creates a wide surround sound field, and expands the sound stage with an improved presence image. This program is used for musical based movies, as well as drama and comedy based movies.
CONCERT VIDEO	This program is effective for music videos and gives excellent depth and clarity for vocals. For opera, the orchestra and stage are ideally recreated, letting you feel as if you were in an actual concert hall.
MONO MOVIE	This program is designed specifically to enhance mono source programs. Compared to a strictly mono setting, the sound image created in this mode is wider and slightly forward of the speaker pair, lending an immediacy to the overall sound. It is particularly effective when used with old mono movies, news broadcasts and dialog.
STADIUM	This program gives you long delays between direct sounds and effect sounds, and extraordinarily spacious feel of a large stadium.
DISCO	This program recreates the acoustic environment of a lively disco in the heart of a very lively city. The sound is dense and highly concentrated. It is also characterized by a high-energy, "immediate" sound.
ROCK CONCERT	This program is ideally suited for rock music. You will experience a very dynamic or lively sound field.
CONCERT HALL	In this program, the center will appear to be deep behind the main speakers, creating an expansive large hall ambience. Orchestra and opera music are suited for this sound field.

Playing a source with an effect of the digital sound field processor (DSP)

RX-V493RDS

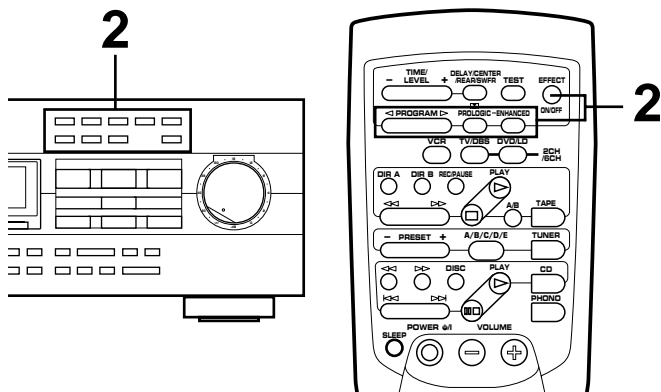

RX-V393RDS

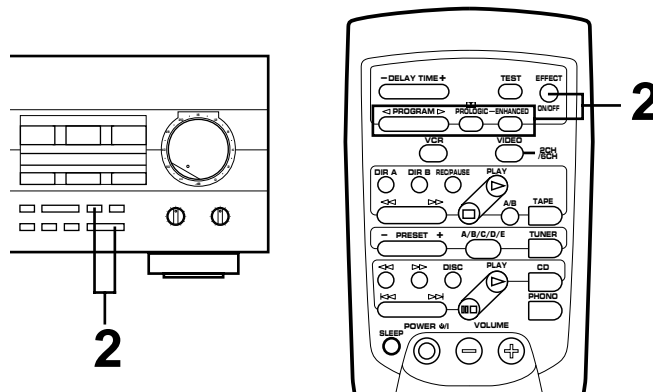

1 Follow steps 1 – 6 shown in “**BASIC OPERATIONS**” on page 25.

2 Select the desired program that is suitable for the source.

RX-V493RDS

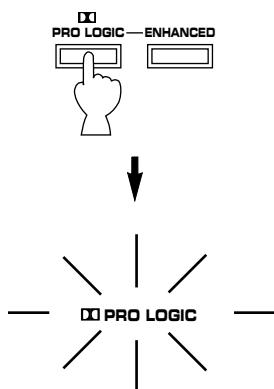

RX-V393RDS

a) 
Turn the DSP on so that a program name lights up on the display.

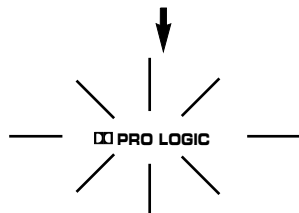

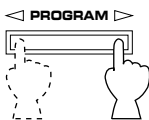
b) 
Select a desired program confirming it on the display.

The selected program name is shown on the display.

3 If desired, adjust the delay time and the output level of each speaker. (For details, refer to the corresponding descriptions on page 40 and 41.)

Notes

- Program selection can be made to individual input sources. Once you select a program, it is linked with the input source selected at that time. So, when you select the input source next time, the same program is automatically called.
- If you prefer to cancel the DSP, press the **EFFECT** button. The sound will be the normal 2-channel stereo without surround sound effect.
- When **CONCERT VIDEO, MONO MOVIE, STADIUM, DISCO, ROCK CONCERT** or **CONCERT HALL** is selected, no sound is heard from the center speaker.
- When a monaural sound source is played with **DOLBY PRO LOGIC** or **DOLBY PRO LOGIC ENHANCED**, no sound is heard from the rear speakers.
- When this unit's Dolby Pro Logic Surround decoder is used, if the main-source sound is considerably altered by overadjustment of the **BASS** or **TREBLE** control, the relationship between the center and rear channels may produce an unnatural effect.
- To select a DSP program on the remote control transmitter, first turn the DSP so that a program name lights up on the display by pressing the **EFFECT** key. Next, select a desired DSP program by pressing the **<** or **>** side of **PROGRAM** key.

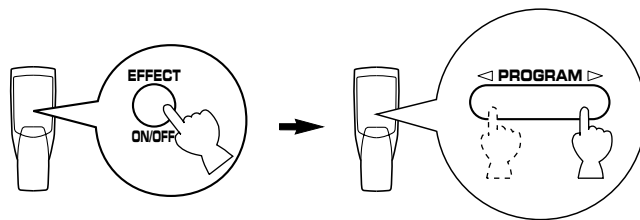

* Pressing the **PROLOGIC** or **ENHANCED** key turns the DSP on and selects the corresponding program directly.

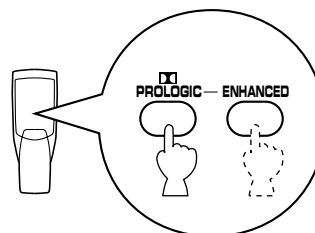

Adjustment of the CENTER LEVEL

If desired, you can adjust the sound output level of the center speaker even if the output level is already set in “**SPEAKER BALANCE ADJUSTMENT**” on page 24.

RX-V493RDS

- 1 Press once or more so that “CENTER” appears on the display.

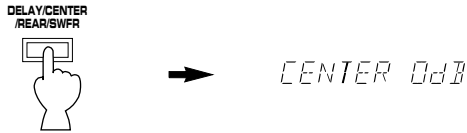

- 2 By continuously pressing the “+” or “-” side of the **TIME/LEVEL** button, the level value changes continuously. The value stops changing momentarily at the preset point (0 dB).

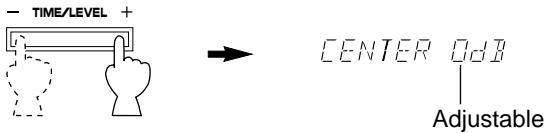

Control range: MIN, -20 to +10 dB

Notes

- This adjustment can be made only when the digital sound field program **DOLBY PRO LOGIC** or **DOLBY PRO LOGIC ENHANCED** is selected.
- Once the output level is adjusted, the level value will be the same in all the digital sound field programs mentioned above.

RX-V393RDS

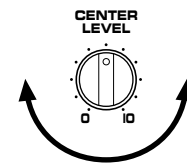

Note

This adjustment is useful only when the digital sound field program **DOLBY PRO LOGIC** or **DOLBY PRO LOGIC ENHANCED** is selected.

Adjustment of the REAR LEVEL

If desired, you can adjust the sound output level of the rear speakers even if the output level is already set in “**SPEAKER BALANCE ADJUSTMENT**” on page 24.

RX-V493RDS

- 1 Press once or more so that “REAR” appears on the display.



- 2 By continuously pressing the “+” or “-” side of the **TIME/LEVEL** button, the level value changes continuously. The value stops changing momentarily at the preset point (0 dB).

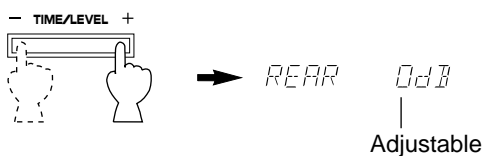

Control range: MIN, -20 to +10 dB

Notes

- This adjustment can be made only when the built-in digital sound field processor is on.
- Once the output level is adjusted, the level value will be the same in all the digital sound field programs.

RX-V393RDS

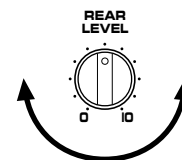

Note

If no digital sound field program is used, this adjustment is useless.

Adjustment of DELAY TIME

You can adjust the time difference between the beginning of the sound from the main speakers and the beginning of the effect sound from the rear speakers.

The larger the value, the later the effect sound is generated. This adjustment can be made to all programs individually.

PRO LOGIC	: from 15 to 30 milliseconds (Preset value: 20 milliseconds)
PRO LOGIC ENHANCED	: from 15 to 30 milliseconds (Preset value: 20 milliseconds)
CONCERT VIDEO	: from 1 to 100 milliseconds (Preset value: 28 milliseconds)
MONO MOVIE	: from 1 to 100 milliseconds (Preset value: 20 milliseconds)
STADIUM	: from 1 to 50 milliseconds (Preset value: 45 milliseconds)
DISCO	: from 1 to 100 milliseconds (Preset value: 14 milliseconds)
ROCK CONCERT	: from 1 to 100 milliseconds (Preset value: 17 milliseconds)
CONCERT HALL	: from 1 to 100 milliseconds (Preset value: 30 milliseconds)

RX-V493RDS

- 1 Press once or more so that "DELAY" appears on the display.



- 2 By continuously pressing the "+" or "-" side of the TIME/LEVEL button, the value changes continuously. The value stops changing momentarily at the preset point.

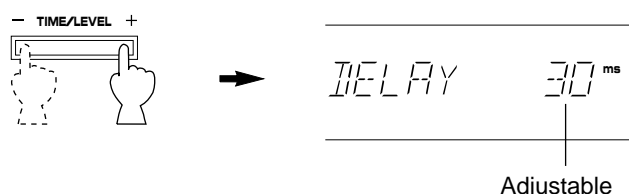

Notes

- When the TIME/LEVEL button is pressed, sound is momentarily interrupted.
- Adding too much delay will cause an unnatural effect with some sources.

RX-V393RDS

This adjustment can be made by only using the remote control transmitter.

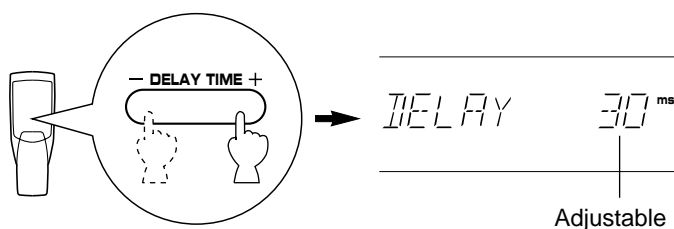

Note

Adding too much delay will cause an unnatural effect with some sources.

Notes

RX-V493RDS only

The values of the delay time, center level, rear level and subwoofer output level you set the last time will remain memorized even when this unit is in the standby mode. However, if the power cord is kept disconnected for more than one week, these values will be automatically changed back to the original factory settings.

RX-V393RDS only

The value of the delay time you set the last time will remain memorized even when this unit is in the standby mode. However, if the power cord is kept disconnected for more than one week, these values will be automatically changed back to the original factory settings.

SETTING THE SLEEP TIMER

If you use the SLEEP timer of this unit, you can make this unit turn into the standby mode. When you are going to sleep while enjoying a broadcast or other desired input source, this timer function is helpful.

Notes

- The SLEEP timer can be controlled only with the remote control transmitter.
- The components on which the SLEEP timer is effective are the sources connected to the **SWITCHED AC OUTLET(S)** on the rear panel of this unit.

To set the SLEEP time

1

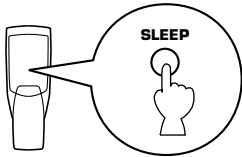

Press once or more to select the desired SLEEP time.



Indicates the SLEEP time.

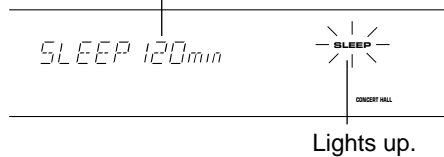

Whenever the **SLEEP** key is pressed, the SLEEP time will change as follows.

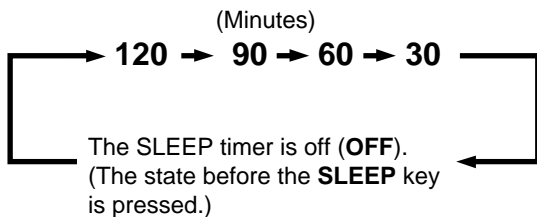

After a while, the display returns to the indication before the SLEEP timer is set.

2

The unit will be turned into the standby mode automatically at the selected SLEEP time.

To cancel the selected SLEEP time

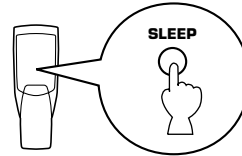

Press once or more so that "SLEEP OFF" appears on the display. (It will soon disappear and the "SLEEP" indicator will go off from the display.)

Note

The SLEEP timer setting can also be canceled by turning this unit into the standby mode with the **STANDBY/ON** switch on the front panel (or the **POWER**  **I** key on the remote control transmitter) or disconnecting the power plug of this unit from the AC outlet.

TROUBLESHOOTING

If the unit fails to operate normally, check the following points to determine whether the fault can be corrected by the simple measures suggested. If it cannot be corrected, or if the fault is not listed in the SYMPTOM column, disconnect the power cord and contact your authorized YAMAHA dealer or service center for help.

	SYMPTOM	CAUSE	REMEDY
Amplifier	The unit fails to turn on when the STANDBY/ON switch is pressed, or turns into the standby mode suddenly soon after the power is turned on.	Power cord is not plugged in or is not completely inserted.	Firmly plug in the power cord.
		The IMPEDANCE SELECTOR switch on the rear panel is not set to the upper or the lower end closely.	Set the switch to the upper or the lower end closely.
	It happens that this unit does not work normally.	There is an influence of strong external noise (lightning, excessive static electricity, etc.) or a misoperation on this unit while using this unit.	Turn this unit into the standby mode and disconnect the AC power cord from the AC outlet. After about 30 seconds have passed, connect the power and operate this unit again.
	No sound or no picture.	Incorrect output cord connections.	Connect the cords properly. If the problem persists, the cords may be defective.
		Appropriate input source is not selected.	Select an appropriate input source with the input selector buttons.
		The SPEAKERS switches are not set properly.	Set the SPEAKERS switch which corresponds to the speakers to be used to the ON position.
		Speaker connections are not secure.	Secure the connections.
	The sound suddenly goes off.	The protection circuit has been activated because of short circuit etc.	Turn this unit into the standby mode, and then turn on to reset the protection circuit.
		The SLEEP timer has functioned.	Cancel the SLEEP timer function.
	Only one side speaker outputs the sound.	Incorrect setting of the BALANCE control.	Adjust it to the appropriate position.
		Incorrect cord connections.	Connect the cords properly. If the problem persists, the cords may be defective.
	Sound "hums".	Incorrect cord connections.	Firmly connect the audio plugs. If the problem persists, the cords may be defective.
		No connection from the turntable to the GND terminal.	Make the GND connection between the turntable and this unit.
	The volume level is low while playing a record.	The record is being played on a turntable with an MC cartridge.	The player should be connected to the unit through the MC head amplifier.
The volume level cannot be increased, or sound is distorted.	The component connected to the REC OUT terminals of this unit is turned off.	Turn the power to the component on.	
No sound from the rear speakers.	The sound output level to the rear speakers is set to minimum.	Raise the sound output level to the rear speakers.	
	The monaural sound source is played in DOLBY PRO LOGIC or DOLBY PRO LOGIC ENHANCED mode.	Select another program suitable for the monaural sound source.	
No sound from the center speaker.	The sound output level to the center speaker is set to minimum.	Raise the sound output level to the center speaker.	
	The center channel mode is in PHANTOM mode.	Select NORMAL or WIDE .	
	Incorrect sound field program selection.	Select the appropriate program.	
FM	FM stereo reception is noisy.	Because of the characteristics of FM stereo broadcasts, this is limited to cases where the transmitter is too far away or the antenna input is poor.	Check the antenna connections. Try using a high quality directional FM antenna. Set the TUNING MODE button to the manual tuning mode.
	There is distortion and clear reception cannot be obtained even with a good FM antenna.	There is multipath interference.	Adjust antenna placement to eliminate multipath interference.
	A desired station cannot be tuned in with the automatic tuning method.	The station is too weak.	Use the manual tuning method. Use a high quality directional FM antenna.
	Previously preset stations can no longer be tuned in.	This unit has been unplugged for a long period.	Repeat the presetting procedure.
AM	A desired station cannot be tuned in with the automatic tuning method.	Weak signal or loose antenna connections.	Tighten the AM loop antenna connections and rotate it for best reception. Use the manual tuning method.
	There are continuous crackling and hissing noises.	Noises will result from lightning, fluorescent lamps, motors, thermostats and other electrical equipment.	Use an outdoor antenna and a ground wire. This will help somewhat but it is difficult to eliminate all noise.
	There are buzzing and whining noises (especially in the evening).	A television set is being used nearby.	Relocate this unit away from the TV.
Remote control Transmitter	The remote control transmitter does not work.	Direct sunlight or lighting (of an inverter type of fluorescent lamp etc.) is striking the remote control sensor of the main unit.	Change the position of the main unit.
		The batteries of this remote control transmitter are too weak.	Replace the batteries with new ones.
Others	The sound is degraded when listening with the headphones connected to the compact disc player or cassette deck that are connected with this unit.	This unit is in the standby mode.	Turn the power to this unit on.

SPECIFICATIONS

AUDIO SECTION

Minimum RMS Output Power per Channel (Power Amp. Section)

Main L, R

8 ohms, 20 Hz to 20 kHz, 0.04% THD	
<RX-V493RDS>	65W+65W
<RX-V393RDS>	50W+50W

Center

8 ohms, 1 kHz, 0.04% THD	
<RX-V493RDS>	65W
<RX-V393RDS>	50W

Rear

8 ohms, 1 kHz, 0.04% THD	20W+20W
--------------------------	---------

Dynamic Power per Channel

(by IHF Dynamic Headroom measuring method)

<RX-V493RDS>	
8/6/4/2 ohms	95/115/145/165W
<RX-V393RDS>	
8/6/4/2 ohms	80/100/120/135W

DIN Standard Output Power per Channel

4 ohms, 1 kHz, 0.7% THD	
<RX-V493RDS>	95W
<RX-V393RDS>	75W

IEC Power

8 ohms, 1 kHz, 0.1% THD	
<RX-V493RDS>	80W
<RX-V393RDS>	60W

Power Band Width

<RX-V493RDS>	
8 ohms, 30W, 0.1% THD	10 Hz to 50 kHz
<RX-V393RDS>	
8 ohms, 25W, 0.1% THD	10 Hz to 50 kHz

Damping Factor (SPEAKERS A)

8 ohms, 20 Hz to 20 kHz	80 or more
-------------------------	------------

Input Sensitivity/Impedance

<RX-V493RDS>	
PHONO MM	2.5 mV/47 k-ohms
CD/TAPE-MD/DVD-LD/TV-DBS/VCR	170 mV/47 k-ohms
6CH DISCRETE INPUT DVD/LD TV/DBS	
MAIN L/R	170 mV/56 k-ohms
CENTER	170 mV/40 k-ohms
REAR L/R	100 mV/40 k-ohms
SUBWOOFER	170 mV/40 k-ohms
<RX-V393RDS>	
PHONO MM	2.5 mV/47 k-ohms
CD/TAPE-MD/VIDEO/VCR	170 mV/47 k-ohms
6CH DISCRETE INPUT VIDEO	
MAIN L/R	170 mV/56 k-ohms
CENTER	170 mV/11 k-ohms
REAR L/R	100 mV/11 k-ohms
SUBWOOFER	170 mV/40 k-ohms

Maximum Input Signal

<RX-V493RDS>	
PHONO MM	
1 kHz, 0.5% THD	100 mV or more
CD/TAPE-MD/DVD-LD/TV-DBS/VCR (EFFECT OFF)	
1 kHz, 0.5% THD	2.5V or more
<RX-V393RDS>	
PHONO MM	
1 kHz, 0.5% THD	100 mV or more
CD/TAPE-MD/VIDEO/VCR (EFFECT OFF)	
1 kHz, 0.5% THD	2.5V or more

Output Level/Impedance

REC OUT	170 mV/2.5 k-ohms
CENTER to PRE OUT	2V/1.2 k-ohms
REAR to PRE OUT	1.2V/1.2 k-ohms
SUBWOOFER (EFFECT OFF)	4V/1.2 k-ohms

Headphone Jack Rated Output/Impedance

Output Level (8 ohms, 0.04% THD)	0.45V
Impedance	330 ohms

Frequency Response (20 Hz to 20 kHz)

<RX-V493RDS>	
CD/TAPE-MD/DVD-LD/TV-DBS/VCR	0±0.5 dB
<RX-V393RDS>	
CD/TAPE-MD/VIDEO/VCR	0±0.5 dB

RIAA Equalization Deviation

PHONO MM	0±0.5 dB
----------	----------

Total Harmonic Distortion (20 Hz to 20 kHz)

<RX-V493RDS>	
PHONO MM to REC OUT	
1V	0.02% or less
CD/TAPE-MD/DVD-LD/TV-DBS/VCR to SP OUT	
30W/8 ohms	0.03% or less
<RX-V393RDS>	
PHONO MM to REC OUT	
1V	0.02% or less
CD/TAPE-MD/VIDEO/VCR to SP OUT	
30W/8 ohms	0.03% or less

Signal-to-Noise Ratio (IHF-A Network)

<RX-V493RDS>	
PHONO MM to REC OUT	
(5 mV Input Shorted)	80 dB or more
CD/TAPE-MD/DVD-LD/TV-DBS/VCR to SP OUT	
(150 mV Input Shorted, EFFECT OFF)	93 dB or more
<RX-V393RDS>	
PHONO MM to REC OUT	
(5 mV Input Shorted)	80 dB or more
CD/TAPE-MD/VIDEO/VCR to SP OUT	
(150 mV Input Shorted, EFFECT OFF)	93 dB or more

Residual Noise (IHF-A Network)

MAIN L/R	140 μV or less
----------	----------------

Channel Separation (Vol. -30 dB, EFFECT OFF)

<RX-V493RDS>

PHONO MM

(Input Shorted, 1 kHz)60 dB or more

CD/TAPE-MD/DVD-LD/TV-DBS/VCR

(Input 5.1 k-ohms Shorted, 1 kHz)60 dB or more

<RX-V393RDS>

PHONO MM

(Input Shorted, 1 kHz)60 dB or more

CD/TAPE-MD/VIDEO/VCR

(Input 5.1 k-ohms Shorted, 1 kHz)60 dB or more

Tone Control Characteristics

BASS: Boost/cut±10 dB (50 Hz)

Turnover Frequency350 Hz

TREBLE: Boost/cut±10 dB (20 kHz)

Turnover Frequency3.5 kHz

Gain Tracking Error (0 to -60 dB)

MAIN L/R3 dB or less

VIDEO SECTION

Video Signal Level1 Vp-p/75 ohms

Maximum Input Level1.5 Vp-p or more

Signal-to-Noise Ratio50 dB or more

Monitor Out Frequency Response5 Hz to 10 MHz, -3 dB

FM SECTION

Tuning Range87.5 to 108.0 MHz

Usable Sensitivity (75 ohms)

DIN, Mono (S/N 26 dB)0.9 μV

DIN, Stereo (S/N 46 dB)24 μV

Selectivity (two signals, 40 kHz Dev. ±300 kHz)70 dB

Signal-to-Noise Ratio

(DIN-Weighted, 40 kHz Dev.)

Mono/Stereo75 dB/70 dB

Harmonic Distortion

Mono/Stereo (40 kHz Dev.)0.1/0.2%

Stereo Separation (40 kHz Dev.)50 dB

Frequency Response

20 Hz to 15 kHz0 ±1.5 dB

Output Level (40 kHz Dev.)

(100% mod., 1 kHz)400 mV

AM SECTION

Tuning Range531 to 1,611 kHz

Usable Sensitivity100 μV/m

Output Level (40 kHz Dev.)

(30% mod., 1 kHz)150 mV

GENERAL

Power SupplyAC 230V, 50 Hz

Power Consumption

<RX-V493RDS>230W

<RX-V393RDS>200W

AC Outlets

2 SWITCHED OUTLETS

[Europe model]100W max. total

1 SWITCHED OUTLET

[U.K. model]100W max. total

Dimensions (W x H x D)435 x 151 x 308.5 mm

(17-1/8" x 5-15/16" x 12-1/8")

Weight

<RX-V493RDS>8.7 kg (19 lbs. 2 oz.)

<RX-V393RDS>7.8 kg (17 lbs. 3 oz.)

AccessoriesAM loop antenna

Indoor FM antenna

75-ohm/300-ohm antenna adapter

(U.K. model only)

Remote control transmitter

Batteries

Specifications are subject to change without notice.

Kanaalscheiding (Vol. -30 dB, EFFECT OFF)

<RX-V493RDS>

PHONO MM

(Ingangssignaal Kortgesloten, 1 kHz)60 dB of meer
CD/TAPE-MD/DVD-LD/TV-DBS/VCR

(Ingangssignaal 5,1 k-ohm Kortgesloten, 1 kHz)60 dB of meer

<RX-V393RDS>

PHONO MM

(Ingangssignaal Kortgesloten, 1 kHz)60 dB of meer
CD/TAPE-MD/VIDEO/VCR

(Ingangssignaal 5,1 k-ohm Kortgesloten, 1 kHz)60 dB of meer

Karakteristieken van Klankregeling

BASS: Versterking/afsluiting.....±10 dB (50 Hz)

Omzetsfrequentie350 Hz

TREBLE: Versterking/afsluiting±10 dB (20 kHz)

Omzetsfrequentie.....3,5 kHz

Spoorafwijking van Versterking (0 tot -60 dB)

MAIN L/R3 dB of minder

VIDEO GEDEELTE

Video-signaalniveau1 Vp-p/75 ohm

Maximum ingangsniveau1,5 Vp-p of meer

Signaal/ruis verhouding50 dB of meer

Monitor-uit frekwentierespons5 Hz tot 10 MHz, -3 dB

FM GEDEELTE

Afstembereik87,5 tot 108,0 MHz

Effectieve Gevoeligheid (75 ohm)

DIN, Mono (Signaal/Ruis 26 dB)0,9 µV

DIN, Stereo (Signaal/Ruis 46 dB).....24 µV

Selectiviteit (twee signalen, 40 kHz Afw. ±300 kHz).....70 dB

Signaal/Ruisverhouding (DIN-norm, 40 kHz Afw.)

Mono/Stereo75/70 dB

Harmonische Vervorming

Mono/Stereo (40 kHz Afw.)0,1/0,2%

Stereo Scheiding (40 kHz Afw.)50 dB

Frekwentiebereik

20 Hz tot 15 kHz0 ± 1,5 dB

Uitgangsniveau (40 kHz Afw.)

(100% mod. 1 kHz).....400 mV

AM GEDEELTE

Afstembereik531 tot 1.611 kHz

Effectieve Gevoeligheid100 µV/m

Uitgangsniveau (40 kHz Afw.)

(30% mod. 1 kHz).....150 mV

ALGEMEEN

Spanningsvereisten230V, 50 Hz wisselstroom

Stroomverbruik

<RX-V493RDS>230W

<RX-V393RDS>200W

Netspanningsuitgangen (AC OUTLETS)

2 GESCHAKELDE NETSPANNINGSUITGANGEN

[Modellen voor Europa]

.....Max. totaal vermogen: 100W

1 GESCHAKELDE NETSPANNINGSUITGANG

[Modellen voor Groot-Brittannië]

.....Max. totaal vermogen: 100W

Afmetingen (L x H x B).....435 x 151 x 308,5 mm

Gewicht

<RX-V493RDS>8,7 kg

<RX-V393RDS>7,8 kg

ToebehorenAM Lusantenne

FM Binnenantenne

75 ohm/300 ohm antenne-adapter
(Alleen modellen voor Groot-Brittannië)

Afstandbediening

Batterijen

Alle specificaties zijn onder voorbehoud en kunnen zondere nadere kennisgeving worden gewijzigd.