

YAMAHA CDX-10

Natural Sound Compact Disc Player

Lecteur de disque audionumérique de la série "Natural Sound"

Thank you for selecting this YAMAHA Compact Disc Player.

Nous vous remercions d'avoir porté votre choix sur ce lecteur de disque.



OWNER'S MANUAL

FEATURES

- Random Access Programmable Play
- Random-Sequence Play
- Single Track/Entire Disc Repeat Play
- Automatic Spacing Capability
- Automatic Programming for Recording to Tape
- Automatic Peak Level Searching Capability
- CD Synchronized Recording with a Compatible YAMAHA Tape Deck
- Display Brightness Changing Capability
- Remote Control Capability
- Optical Digital Output

CONTENTS

| | |
|--|----|
| Safety Instructions | 2 |
| Connections | 4 |
| Identification of Components | 5 |
| Basic Operation | 7 |
| Random-Sequence Play | 10 |
| Repeat Play | 10 |
| Program Play | 11 |
| Index Search | 12 |
| Track Programming for Recording to Tape | 13 |
| CD Synchronized Recording | 17 |
| Notes about the Remote Control Transmitter | 18 |
| Notes about Handling Compact Discs | 18 |
| Troubleshooting | 19 |
| Specifications | 19 |

MODE D'EMPLOI



CARACTERISTIQUES

- Lecture programmable à accès direct
- Lecture en séquence aléatoire
- Lecture répétée de plage unique/disque entier
- Fonction d'espacement automatique
- Programmation automatique de pour l'enregistrement
- Fonction de recherche automatique du niveau de crête
- Enregistrement synchronisé de disque audionumérique avec un magnétophone à cassettes compatible YAMAHA
- Fonction de modification de luminosité de l'affichage
- Fonctionnement par télécommande
- Sortie numérique optique

TABLE DES MATIERES

| | |
|--|----|
| Attention | 20 |
| Connexions | 21 |
| Identification des composants | 22 |
| Fonctionnement de base | 24 |
| Lecture en séquence aléatoire | 27 |
| Lecture répétée | 27 |
| Lecture programmée | 28 |
| Recherche d'index | 29 |
| Programmation des plages pour enregistrement sur bande | 30 |
| Enregistrement synchronisé d'un disque audionumérique | 34 |
| Remarques concernant la télécommande | 35 |
| Remarques concernant la manipulation des disques ... | 35 |
| Dépistage de pannes | 36 |
| Caractéristiques techniques | 36 |

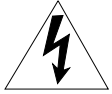
SAFETY INSTRUCTIONS

| | | |
|---|---|---|
|  | CAUTION RISK OF ELECTRIC SHOCK DO NOT OPEN |  |
| <p>CAUTION: TO REDUCE THE RISK OF ELECTRIC SHOCK, DO NOT REMOVE COVER (OR BACK). NO USER-SERVICEABLE PARTS INSIDE. REFER SERVICING TO QUALIFIED SERVICE PERSONNEL.</p> | | |

• Explanation of Graphical Symbols

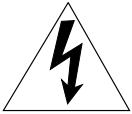

The lightning flash with arrowhead symbol, within an equilateral triangle, is intended to alert you to the presence of uninsulated "dangerous voltage" within the product's enclosure that may be of sufficient magnitude to constitute a risk of electric shock to persons.



The exclamation point within an equilateral triangle is intended to alert you to the presence of important operating and maintenance (servicing) instructions in the literature accompanying the appliance.

| |
|--|
| <p>WARNING TO REDUCE THE RISK OF FIRE OR ELECTRIC SHOCK, DO NOT EXPOSE THIS UNIT TO RAIN OR MOISTURE.</p> |
|--|

- 1 Read Instructions – All the safety and operating instructions should be read before the unit is operated.
- 2 Retain Instructions – The safety and operating instructions should be retained for future reference.
- 3 Heed Warnings – All warnings on the unit and in the operating instructions should be adhered to.
- 4 Follow Instructions – All operating and other instructions should be followed.
- 5 Water and Moisture – The unit should not be used near water – for example, near a bathtub, washbowl, kitchen sink, laundry tub, in a wet basement, or near a swimming pool, etc.
- 6 Carts and Stands – The unit should be used only with a cart or stand that is recommended by the manufacturer.
- 6A A unit and cart combination should be moved with care. Quick stops, excessive force, and uneven surfaces may cause the unit and cart combination to overturn.
- 7 Wall or Ceiling Mounting – The unit should be mounted to a wall or ceiling only as recommended by the manufacturer.
- 8 Ventilation – The unit should be situated so that its location or position does not interfere with its proper ventilation. For example, the unit should not be situated on a bed, sofa, rug, or similar surface, that may block the ventilation openings; or placed in a built-in installation, such as a bookcase or cabinet that may impede the flow of air through the ventilation openings.
- 9 Heat – The unit should be situated away from heat sources such as radiators, stoves, or other appliances that produce heat.



- 10 Power Sources – The unit should be connected to a power supply only of the type described in the operating instructions or as marked on the unit.
- 11 Power-Cord Protection – Power-supply cords should be routed so that they are not likely to be walked on or pinched by items placed upon or against them, paying particular attention to cords at plugs, convenience receptacles, and the point where they exit from the unit.
- 12 Cleaning – The unit should be cleaned only as recommended by the manufacturer.
- 13 Nonuse Periods – The power cord of the unit should be unplugged from the outlet when left unused for a long period of time.
- 14 Object and Liquid Entry – Care should be taken so that objects do not fall into and liquids are not spilled into the inside of the unit.
- 15 Damage Requiring Service – The unit should be serviced by qualified service personnel when:
 - A. The power-supply cord or the plug has been damaged; or
 - B. Objects have fallen, or liquid has been spilled into the unit; or
 - C. The unit has been exposed to rain; or
 - D. The unit does not appear to operate normally or exhibits a marked change in performance; or
 - E. The unit has been dropped, or the cabinet damaged.
- 16 Servicing – The user should not attempt to service the unit beyond those means described in the operating instructions. All other servicing should be referred to qualified service personnel.
- 17 Power Lines – An outdoor antenna should be located away from power lines.
- 18 Grounding or Polarization – Precautions should be taken so that the grounding or polarization is not defeated.

We Want You Listening For A Lifetime (for US customers only)

YAMAHA and the Electronic Industries Association's Consumer Electronics Group want you to get the most out of your equipment by playing it at a safe level. One that lets the sound come through loud and clear without annoying blaring or distortion – and, most importantly, without affecting your sensitive hearing. Since hearing damage from loud sounds is often undetectable until it is too late, YAMAHA and the Electronic Industries Association's Consumer Electronics Group recommend you to avoid prolonged exposure from excessive volume levels.



IMPORTANT!

Please record the serial number of this unit in the space below.

Model:
Serial No.:

The serial number is located on the rear of the unit. Retain this Owner's Manual in a safe place for future reference

CAUTION: READ THIS BEFORE OPERATING YOUR UNIT

- 1 To ensure the finest performance, please read this manual carefully. Keep it in a safe place for future reference.
- 2 Install your unit in a cool, dry, clean place – away from windows, heat sources, and too much vibration, dust, moisture or cold. Avoid sources of hum (transformers, motors). To prevent fire or electrical shock, do not expose to rain and water.
- 3 Do not operate the unit upside-down. It may overheat, possibly causing damage.
- 4 Never open the cabinet. If a foreign object drops into the set, contact your dealer.
- 5 Do not use force on switches, knobs or cords. When moving the set, first turn the unit off. Then gently disconnect the power plug and the cords connecting to other equipment. Never pull the cord itself.
- 6 Do not attempt to clean the unit with chemical solvents; this might damage the finish. Use a clean, dry cloth.
- 7 Be sure to read the “TROUBLESHOOTING” section on common operating errors before concluding that your unit is faulty.
8. Do not place another component on top of this unit, because to do so will discolor or damage the surface of the unit.
9. To prevent damage by lightning, disconnect the power cord from the household AC outlet during an electrical storm.
10. When disconnecting the power cord from the household AC outlet, grasp the plug; do not pull the cord.
11. When moving the unit, be sure to first disconnect the power cord from the household AC outlet, and disconnect cords connected to other equipment.

The apparatus is not disconnected from the AC power source as long as it is connected to the wall outlet, even if the apparatus itself is turned off.

CAUTION (FOR CANADIAN CUSTOMERS)

TO PREVENT ELECTRIC SHOCK, MATCH WIDE BLADE OF PLUG TO WIDE SLOT AND FULLY INSERT.

THIS CLASS B DIGITAL APPARATUS MEETS ALL REQUIREMENTS OF THE CANADIAN INTERFERENCE-CAUSING EQUIPMENT REGULATIONS.

WARNING

CAUTION

Use of controls or adjustments or performance of procedures other than those specified herein may result in hazardous radiation exposure.

DANGER

Invisible laser radiation when open and interlock failed or defeated.
Avoid direct exposure to beam.

As the laser beam used in this compact disc player is harmful to the eyes, do not attempt to disassemble the cabinet. Refer servicing to qualified personnel only.

To avoid electrical shock, do not open the unit. Refer servicing to qualified personnel only.

DANGER: The use of optical instrument with this product will increase eye hazard.

Laser Diode Properties

- Material: GaAIAs
- Wavelength: 780nm
- Emission Duration: continuous
- Laser Output: max. 44.6 μ W*

* This output is the value measured at a distance of about 200mm from the objective lens surface on the Optical Pick-up Block.

FCC INFORMATION (for US customers only)

1. IMPORTANT NOTICE : DO NOT MODIFY THIS UNIT!

This product, when installed as indicated in the instructions contained in this manual, meets FCC requirements. Modifications not expressly approved by Yamaha may void your authority, granted by the FCC, to use the product.

2. **IMPORTANT :** When connecting this product to accessories and/or another product use only high quality shielded cables. Cable/s supplied with this product **MUST** be used. Follow all installation instructions. Failure to follow instructions could void your FCC authorization to use this product in the USA.

3. **NOTE :** This product has been tested and found to comply with the requirements listed in FCC Regulations, Part 15 for Class “B” digital devices. Compliance with these requirements provides a reasonable level of assurance that your use of this product in a residential environment will not result in harmful interference with other electronic devices.

This equipment generates/uses radio frequencies and, if not installed and used according to the instructions found in the users manual, may cause interference harmful to the operation of other electronic devices.

Compliance with FCC regulations does not guarantee that interference will not occur in all installations. If this product is found to be the source of interference, which can be determined by turning the unit “OFF” and “ON”, please try to eliminate the problem by using one of the following measures:

Relocate either this product or the device that is being affected by the interference.

Utilize power outlets that are on different branch (circuit breaker or fuse) circuits or install AC line filter/s.

In the case of radio or TV interference, relocate/reorient the antenna. If the antenna lead-in is 300 ohm ribbon lead, change the lead-in to coaxial type cable.

If these corrective measures do not produce satisfactory results, please contact the local retailer authorized to distribute this type of product. If you can not locate the appropriate retailer, please contact Yamaha Electronics Corp., U.S.A. 6660 Orangethorpe Ave, Buena Park, CA 90620.

The above statements apply **ONLY** to those products distributed by Yamaha Corporation of America or its subsidiaries.

CONNECTIONS

- Before making any connections, switch OFF the power to the unit and the amplifier or other component.
- Connections should be made to the correct input terminals of the amplifier or other component.

- If the placement of this unit causes noise to other equipment, such as a tuner, separate them from each other.

1

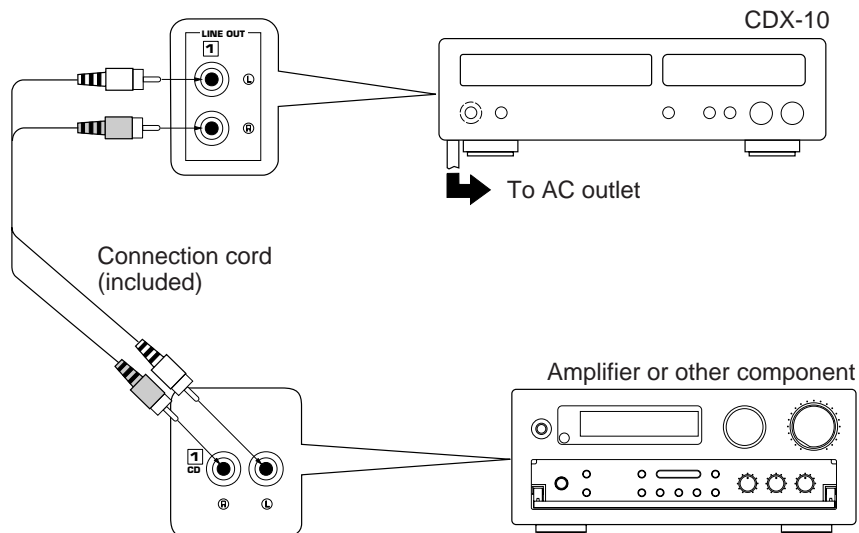

2

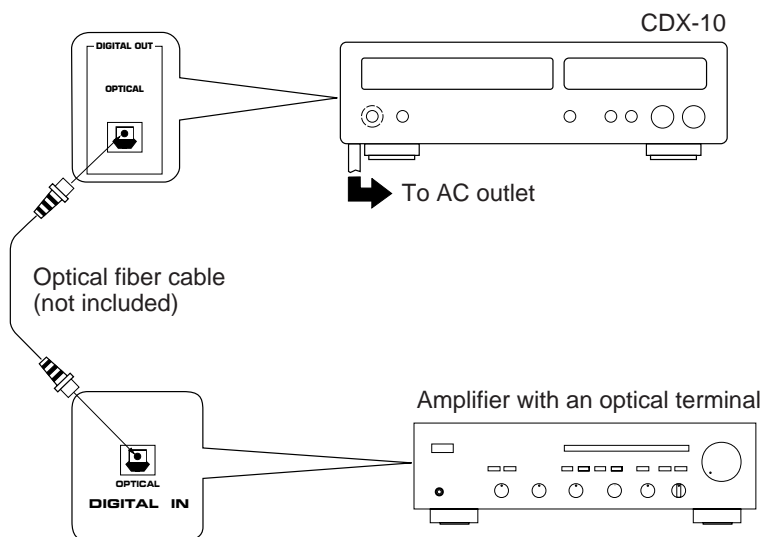

Choose one of the ways listed below to connect this unit to your amplifier.

When the LINE OUT (analog) terminals of this unit are used (1)

- Be sure that the left (“L”) and right (“R”) LINE OUT terminals are connected to the corresponding (left and right) terminals of the amplifier or other component.
- Connect the “LINE OUT” terminals to the “CD” (or “AUX”) terminals of the amplifier. If the amplifier does not have such terminals, use the “TAPE PB” terminals. For additional details concerning these connections, refer to the operation instructions for the amplifier being used.
- The LINE OUT terminals of this unit are numbered 1. When connecting this unit with a YAMAHA amplifier or receiver whose terminals on the rear panel are numbered as 1, 2, 3, etc., connect the LINE OUT terminals of this unit to the input terminals numbered 1 on the rear of the amplifier or receiver.

When the DIGITAL OUT (OPTICAL) terminal of this unit is used (2)

- Before using this terminal, remove the terminal's cover by pulling it.
- Make the connection from this terminal to the optical input terminal of an amplifier by using a commercially available optical fiber cable.
 - * Use an optical fiber cable that conforms to EIAJ standards. Other cables might not function correctly.
- Be sure to attach the terminal's cover when this terminal is not being used, in order to protect the terminal from dust.
- This terminal can also be connected to the optical input terminal of a digital audio tape deck (DAT) etc. to record CD onto tape directly.

IDENTIFICATION OF COMPONENTS

* () indicates the page number on which the control part is best described.

FRONT PANEL

* The **PLAY/PAUSE** button on the main unit has both the functions of the **PLAY** button and the **PAUSE** button on the remote control transmitter.

* The **SKIP/SEARCH** buttons on the main unit have both the functions of the **SKIP** buttons and the **SEARCH** buttons on the remote control transmitter.

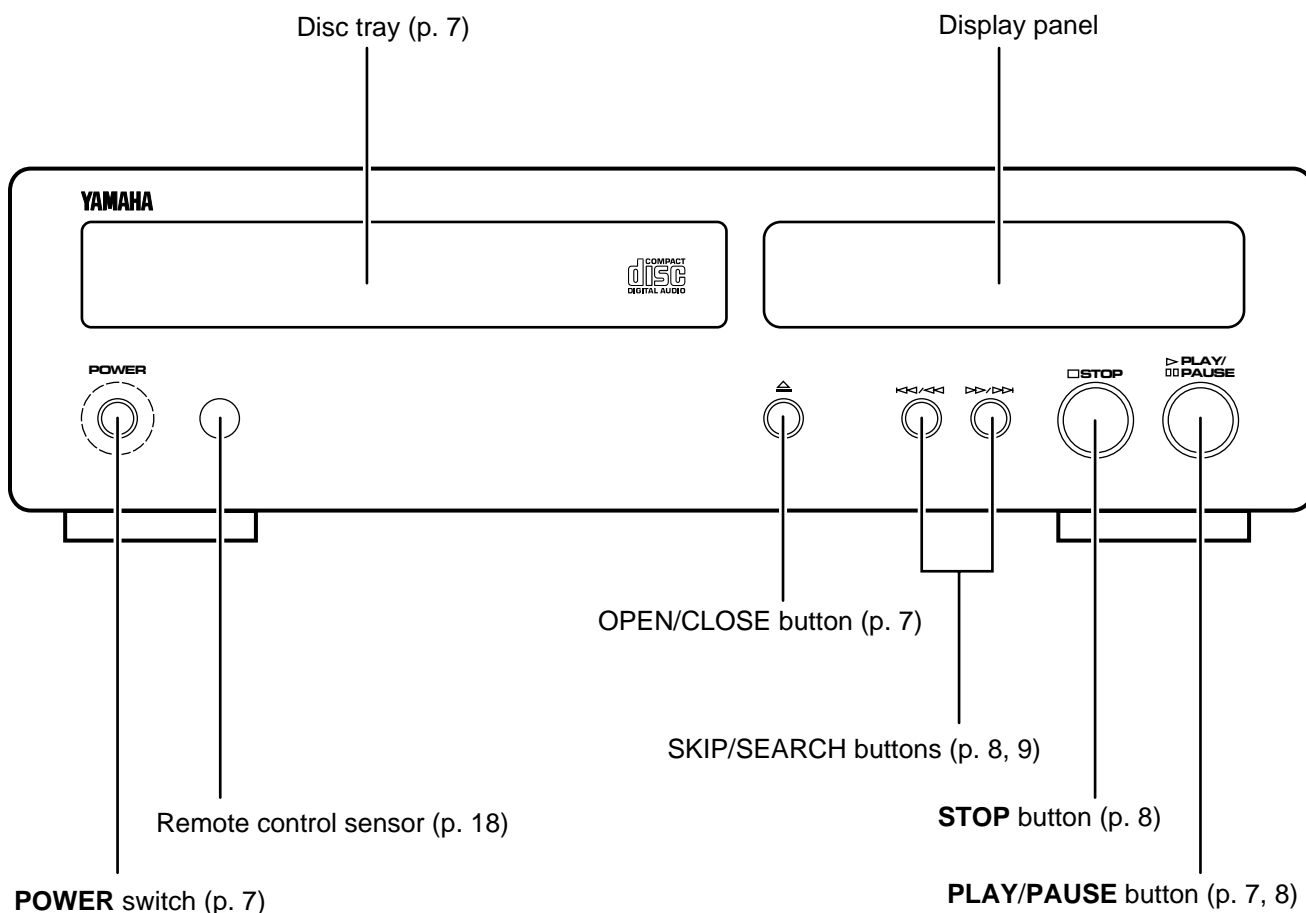

* () indicates the page number on which the control part is best described.

REMOTE CONTROL TRANSMITTER

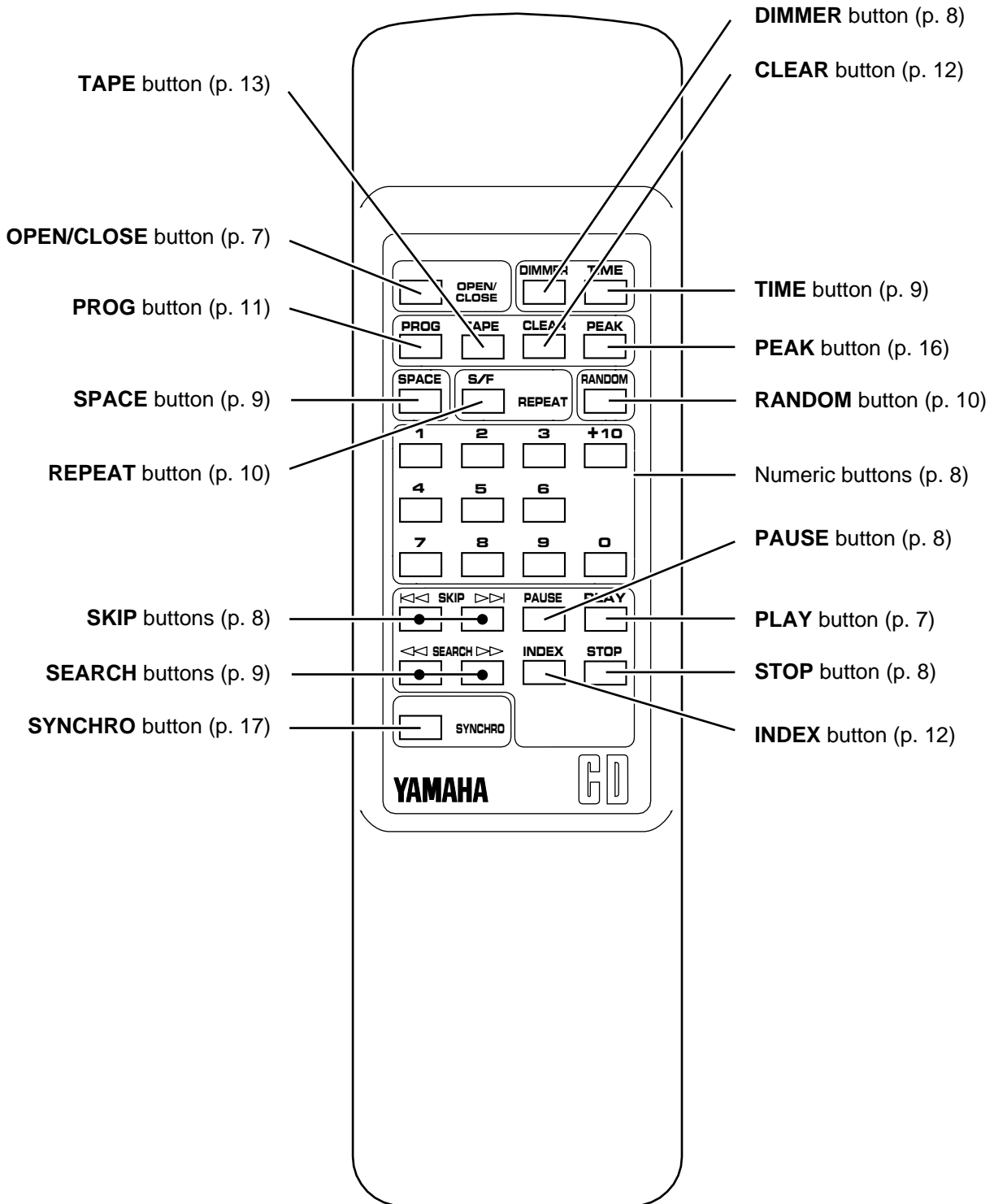

This manual describes how to operate this unit by using the remote control transmitter.
To operate this unit on the front panel, use the corresponding buttons on the front panel.

BASIC OPERATION

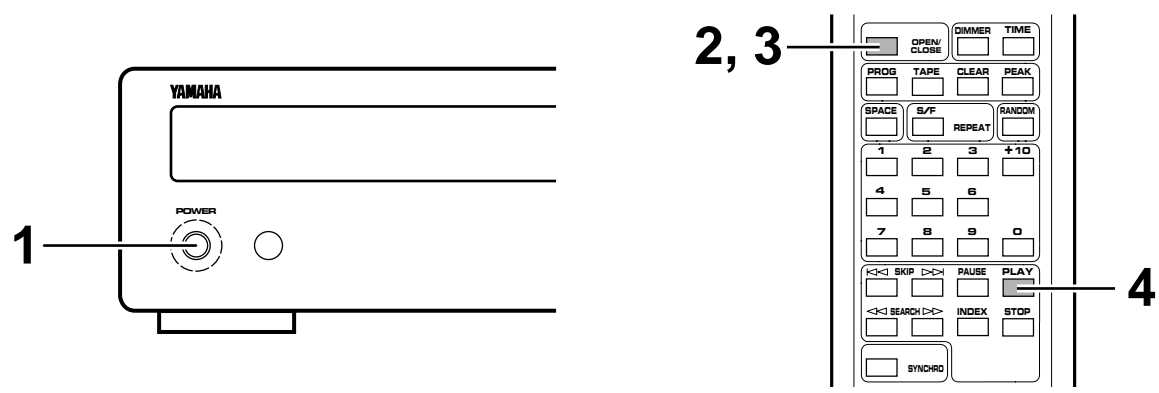

1 Turn the power on.

2 Load a disc.

Label side upward

Disc tray

3 Close the disc tray.

4

Play will begin from the first track of the disc.

Display information at disc play

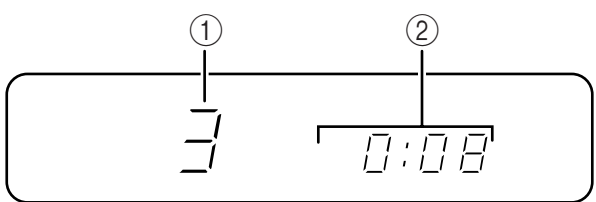

- ① Shows the track number selected or being played.
- ② Shows the time displays. (Refer to "Selecting time displays" on page 9.)

Notes

- After closing the disc tray by pressing the **OPEN/CLOSE** button, the display shows the total number of tracks and the total recorded time of the disc for a few seconds.

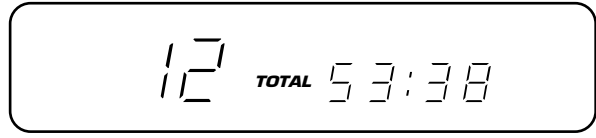

- Additionally, you can close the disc tray by pressing the **PLAY (PLAY/PAUSE)** button, a numeric button or the **RANDOM** button, or by pressing the front edge of the disc tray gently. If the tray is closed in these ways, play will begin automatically, however, the display will not show the total number of tracks and the total recorded time of the disc.

To turn off the power

Press the **POWER** switch again.

To stop play temporarily

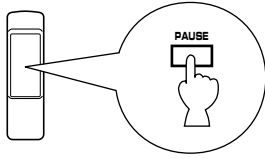

To resume play, press the **PAUSE** button again (or press the **PLAY** button).

* The **PLAY/PAUSE** button on the front panel can also be used to stop play temporarily or to resume play.

To stop play completely

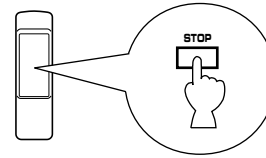

To play a desired track on the disc

DIRECT PLAY

Select a desired track using the numeric button.

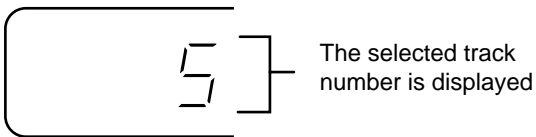
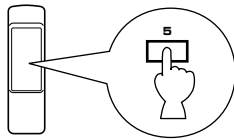

Example: To select track 25
Press ① twice, then immediately press ② once.

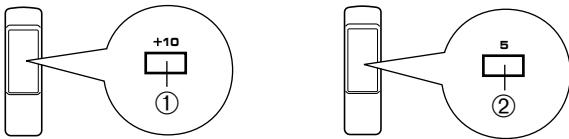

* If a track number higher than the highest track number on the disc is selected, the last track on the disc will be played.

SKIP PLAY

To play from the beginning of the track following the one now playing

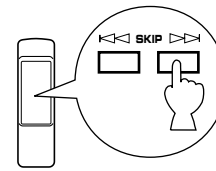

To play from the beginning of the track now playing

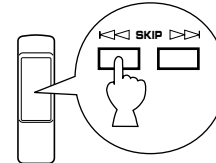

To play from the beginning of the track before the one now playing

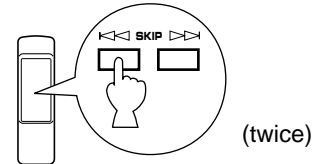

- These operations can also be performed when the unit is in the pause or stop mode.

- When using the **SKIP** buttons on the remote control transmitter:

If a button is pressed and held, the track number is continuously changed to higher numbers (or lower numbers).

When using the **SKIP/SEARCH** buttons on the front panel: Be careful not to press and hold a button, otherwise the selected track is played forward (or backward) rapidly.

Changing brightness of the display

You can change the brightness of the display by pressing the **DIMMER** button.

Normal illumination



Slightly Dim



Dim

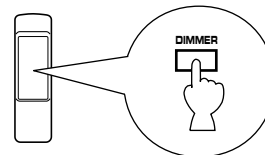

To advance or reverse play rapidly (MANUAL SEARCH)

To advance rapidly

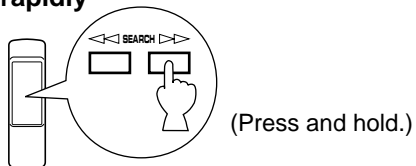

To reverse rapidly

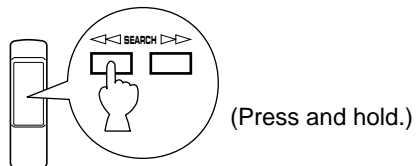

- The sound can be heard (although slightly garbled) during manual search in either direction. This is convenient for locating a precise position within a track, or for reviewing the contents quickly.
- Manual search can also be performed while disc play is paused, though no sound will be heard.
- When using the SKIP/SEARCH buttons on the front panel: Be careful not to release a button just after it is pressed, otherwise the play is skipped to the beginning of the next track or returned to the beginning of the current track.

Automatic spacing

If you record a disc onto tape with an insufficient time space between tracks, the tape deck will not be able to perform blank search operations on the tape correctly. Such a search mistake of the deck can be prevented by pressing the auto-SPACE button to insert spaces of about 4 seconds between the tracks before recording.

Note

When the automatic spacing function is in effect, the display of the total time and of the total remaining time will include each of the 4 second non-recorded intervals placed between tracks.

To cancel the automatic spacing function

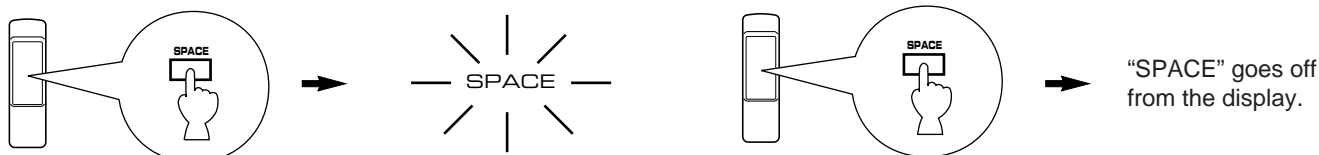

Selecting time displays

You can select any of the four time displays by pressing the TIME display mode-select button.

① Elapsed time of the track now playing

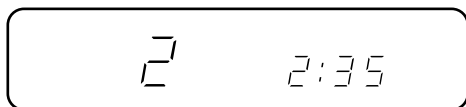

② Remaining time of the track now playing

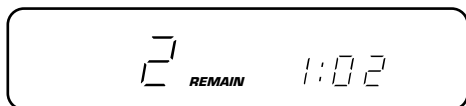

④ Total remaining time on the disc

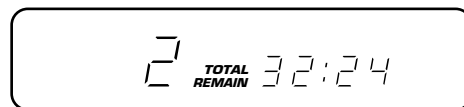

③ Total disc play time

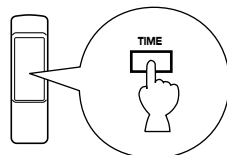
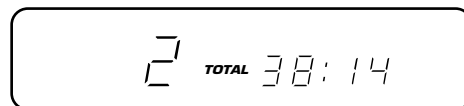

Note

The remaining time ② will not be displayed if the track number is 25 or higher.

RANDOM-SEQUENCE PLAY

You can have the unit play the tracks on a disc in a random sequence selected by the unit's microcomputer.

To perform random-sequence play

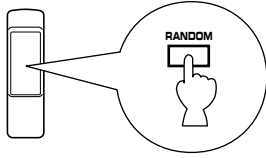

To cancel random-sequence play

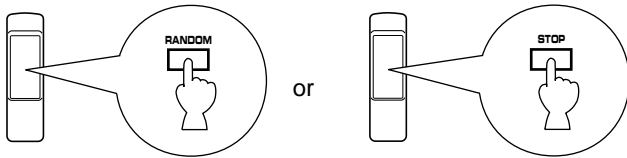

Notes

- This feature will not function during programming, or during programmed play.
- If the **POWER** is switched off when the random-sequence play is being performed, pressing the **POWER** switch again to turn the unit on will begin the random-sequence play automatically. (This feature is useful for timer play.)
- If the **SKIP** \gg button is pressed during random-sequence play, the next randomly programmed track will be played. If the **SKIP** \ll button is pressed, play will return to the beginning of the track now being played.
-  This indication appears while the unit is mixing up tracks.
- Total remaining time on the disc will not be displayed during random-sequence play.

REPEAT PLAY

You can play any desired track or the entire disc repeatedly by pressing the **REPEAT** button. The repeat play mode will change whenever you press the **REPEAT** button.

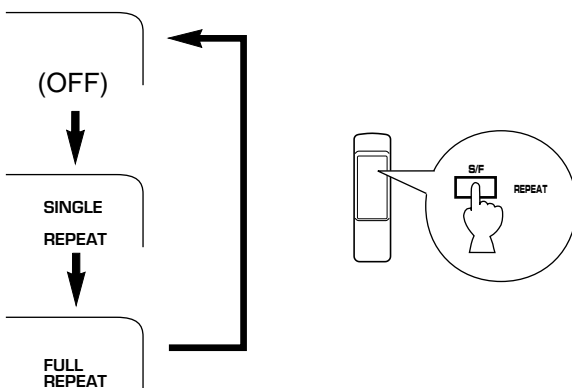

SINGLE REPEAT

A single track is repeatedly played.

* This is also available in the programmed-play mode and the random-sequence play mode.

(If the repeat play mode is switched off, the programmed-play mode or the random-sequence play mode will be resumed.)

FULL REPEAT

All tracks (the entire disc) are played repeatedly.

* In the programmed-play mode, all programmed tracks are repeatedly played.

* In the random-sequence play mode, all randomly sequenced tracks are repeatedly played in the same order.

PROGRAM PLAY

You can enjoy listening to your favorite tracks in any desired order by programming tracks. As many as 25 tracks can be programmed in sequence.

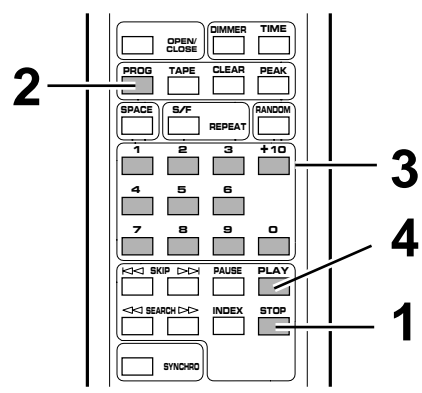

1 Stop the unit.

2

3 Program a desired track by pressing the corresponding numeric button.

* Repeat this operation to program more tracks. You can select the same track again.

4

Display information during programming

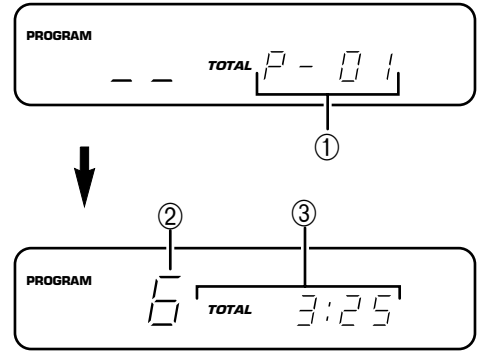

- ① Shows the program number for the track to be programmed next.
- ② Shows the selected track number.
- ③ Shows the total time of the tracks currently programmed.

* If the total time becomes 100 minutes or more, the highest position of a figure will not be displayed.

Notes

- In step 2, if "P-01" does not appear in the display, press the **TIME** display mode-select button.
- If, during programming, the **TIME** display mode-select button is pressed, the program number display can be changed to display the total time of the programmed tracks. To return to the previous display, press the **TIME** display mode-select button once again.
- The **SKIP** (<<< and >>>) button can be used during playing, but only within the range of the programmed tracks.
- The **SEARCH** (<<< and >>>) button can be used during playing to search all tracks, including unprogrammed tracks.
- The **PAUSE** mode can also be programmed (one time only), if so desired, by pressing the **TAPE** button instead of a numeric button. (In this case, " Q O B" is illuminated on the display.)
- If, for a compact disc with 25 tracks or more, track number 25 or higher is programmed, the total time will disappear from the display.

To stop program play

Press the **STOP** button. The first programmed track number will be displayed.

To resume play, press the **PLAY** button. Play will begin from the beginning of the program.

To cancel a program sequence

There are several methods, as described below.

- Press the **STOP** button or the **CLEAR** button while the unit is stopped.
- Open the disc tray.
- Switch off the power.

To check program data

1. If during program play, press the **STOP** button.
2. Press the **PROG** button.
3. Each time the **SKIP** $\triangleright\triangleright$ button is pressed, the track numbers and sequential order of the programmed tracks can be checked one after another. The display of the track number can be returned (sequentially in reverse order) by pressing the **SKIP** $\triangleleft\triangleleft$ button.

To correct program data

1. Follow the procedure described in "To check program data".
2. Display the track number to be corrected by pressing the **SKIP** button.
3. Press a numeric button to select a track to replace the one displayed. The previously programmed track will be cleared from the memory and the new one will be programmed.
4. After the correction has been completed, once again press the **PROG** button or the **PLAY** button.

INDEX SEARCH

If the disc includes index numbers, play can be started from any desired index number.

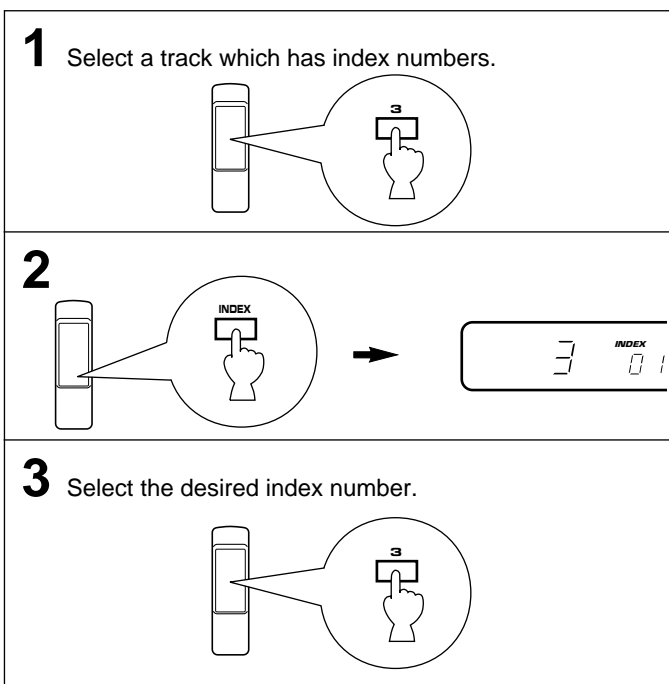
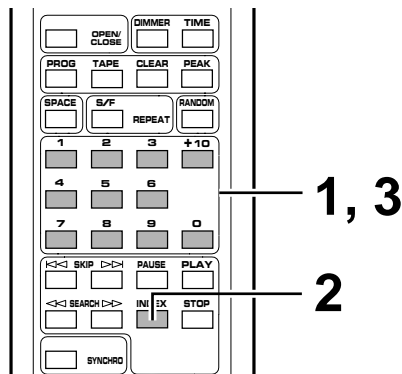

To cancel the index search function

Press the **INDEX** button.

Notes

- Not all discs have index numbers. The index system is a method for sub-dividing tracks into smaller divisions (such as, for example, the movements within classical symphonies) for easier location of those parts. The liner notes with the disc usually tell if such index numbers are included.
- If an index number is selected that is higher than any index number on that disc, play will start from the last index number point on the disc.
- For some discs, play may begin slightly prior to the actual designated index point.
- If the disc has no encoded index points, play will begin from the start of the selected track.
- The index number can be designated only while the **INDEX** number display is illuminated.

TRACK PROGRAMMING FOR RECORDING TO TAPE

This convenient feature can be used to program tracks on a disc for recording to tape. By only memorizing the tape's total possible recording time, the unit will automatically program tracks or help you to program tracks so they will fit onto the tape with the least amount of unrecorded space remaining at each end of the tape.

Automatic tape-programming

This is for recording only the tracks which best fit onto a tape.

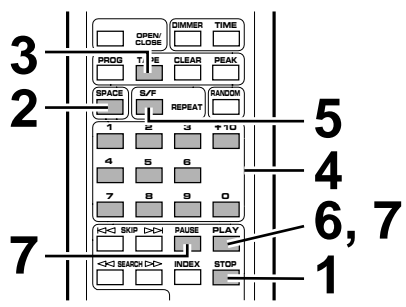

1 Stop the unit.

* The peak level searching function of this unit is useful for adjusting recording level on the tape deck. (Refer to page 16.)

2 If desired, you can automatically insert additional time space between tracks. (Refer to page 9.)

3 Enter the tape's total possible recording time.

You can select any of four tape lengths by pressing the **TAPE** button.

4 Otherwise, you can also enter the tape's total possible recording time manually.

Example: For a C-64 tape (32 minutes on each side)

5 Press the **REPEAT** button.

* The unit automatically programs tracks for side A and side B separately considering the tape's total time.

6 Begin recording on the tape deck and press the **PLAY** button on this unit at the same time.

7 The unit will pause at the end of side A of the tape. Turn the tape over to side B. Resume recording and, at the same time, press the **PLAY** or **PAUSE** button on this unit.

- Notes**
- All tracks may not be programmed if the tape's length is not enough. To program all tracks, use a longer tape.
 - In step 5, you can check the program data for side A and side B.

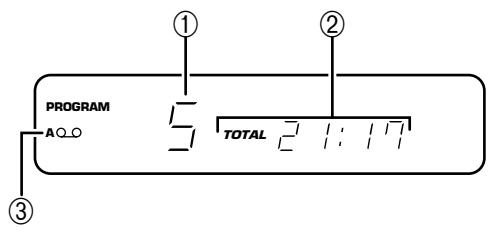

- ① Shows the number of programmed tracks for each side in turn just after the automatic programming is finished, and then it is replaced by the number of the first programmed track for side A.
- ② Shows the total time of programmed tracks for each side.
- ③ Shows the side of the tape.

- CD synchronized recording function can be used if your tape deck is compatible with it. If so, in step 6 and 7, press the **SYNCHRO** button and then press the **PLAY** button on this unit's remote control transmitter. Recording automatically begins. (For details, refer to page 17.)

Manual tape-programming

This is for recording desired tracks in any desired order onto a tape.

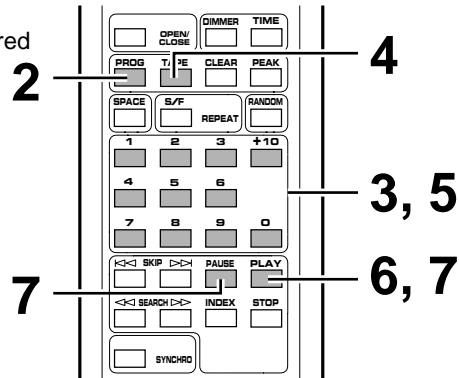

1 Follow steps 1 – 4 on page 13.

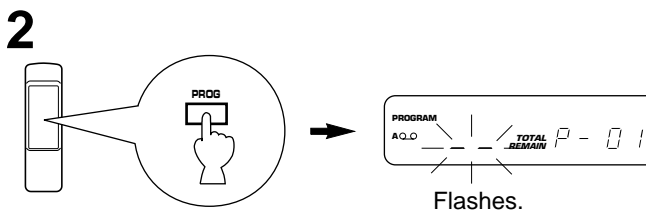

3 Program desired tracks (to be recorded on side A) in any desired order.

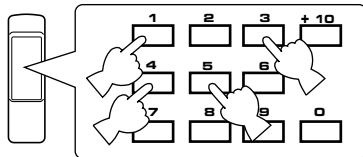

4 When track selection for side A is finished, press the **TAPE** button.

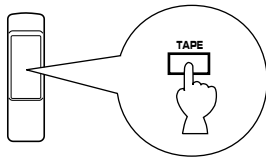

A pause mode is programmed.

5 Select the track numbers (to be recorded on side B) in any desired order.

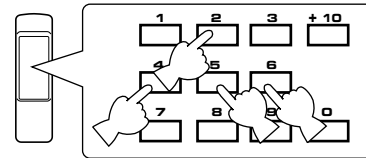

6 Begin recording on the tape deck and press the **PLAY** button on this unit at the same time.

7 The unit will pause at the end of side A of the tape. Turn the tape over to side B. Resume recording and, at the same time, press the **PLAY** or **PAUSE** button on this unit.

Notes

- If, in step 3 or 5, “E rr” appears on the display, the track number just selected cannot be programmed because there is not enough time remaining on the tape.
- In step 3 or 5, each time a selection is made, the track number and the tape’s remaining time will be displayed, and then the display will change to indicate the next program number.
- CD synchronized recording function can be used if your tape deck is compatible with it. If so, in step 6 and 7, press the **SYNCHRO** button and then press the **PLAY** button on this unit’s remote control transmitter. Recording automatically begins. (For details, refer to page 17.)

Notes on tape programming

- To check, cancel or correct program data, refer to page 12.
 - * In checking the program data, note that “Pu” appears between track numbers for side A and side B.
- Up to a maximum of 25 tracks can be programmed. If, however, the PAUSE mode is inserted, it is counted as one track.

- This function can be used to program up to track number 24. If the disc has more than 24 tracks, track number 25 and thereafter will not be programmed.

■ Random sequential tape-programming

The unit will automatically program tracks in random sequential order for recording to tape.

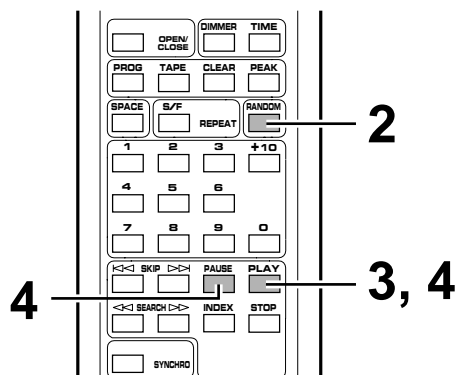

1 Follow steps 1 – 4 on page 13.

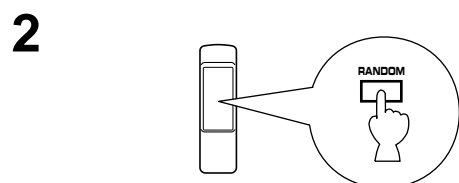

* The unit will automatically program tracks for side A and side B separately considering the tape's total time.

3 Begin recording on the tape deck and press the **PLAY** button on this unit at the same time.

4 The unit will pause at the end of side A of the tape. Turn the tape over to side B. Resume recording and, at the same time, press the **PLAY** or **PAUSE** button on this unit.

Notes

- Because the programmed data changes every time the **RANDOM** button is pressed, the amount of time remaining at the end of the tape also changes accordingly.
- If the tape's length is not enough, all tracks cannot be programmed. In this case, exchange the tape for a longer one.
- In step 2, you can check the program data for side A and side B.

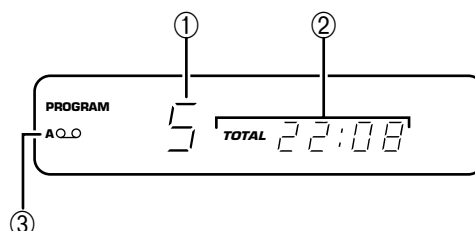

- ① Shows the number of programmed tracks for each side in turn just after the automatic programming is finished, and then it is replaced by the number of the first programmed track for side A.
- ② Shows the total time of programmed tracks for each side.
- ③ Shows the side of the tape.

- CD synchronized recording function can be used if your tape deck is compatible with it. If so, in step 3 and 4, press the **SYNCHRO** button and then press the **PLAY** button on this unit's remote control transmitter. Recording automatically begins. (For details, refer to page 17.)

Automatic searching for the peak level on a disc

This convenient feature automatically searches a disc for a part where the source level peaks, and next plays the part repeatedly. For recording to tape, this feature is very helpful to adjust the recording level on the tape deck.

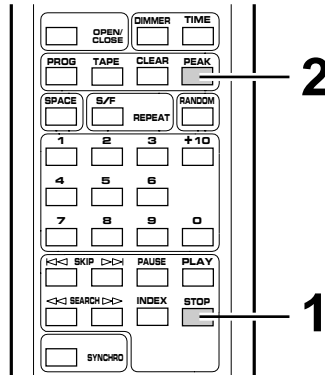

1 Stop the unit.

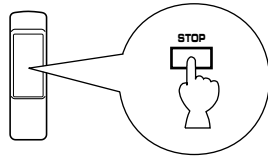

2

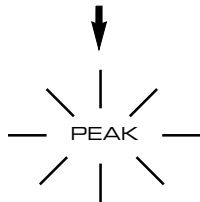
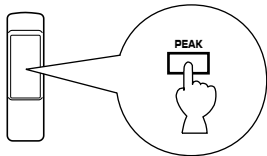

The peak level search is performed on the disc.

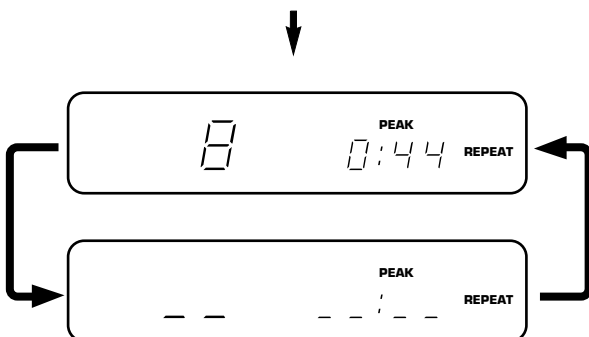

Next, the part where the source level peaks is repeatedly played.
Adjust the recording level on the tape deck listening to this sound.

To cancel this function

Press the **STOP** button. (Some other buttons can also be used to cancel this function.)

Notes

- Even if the peak level search is performed twice or more on the same disc, the same part will not be always selected, because this unit will search for the peak level among parts on the disc that are randomly selected by the internal microcomputer.
- In the program play mode, this feature will function among the programmed tracks only. If program play is being performed, first press the **STOP** button, and then press the **PEAK** button. If program play is not being performed, only press the **PEAK** button.

CD SYNCHRONIZED RECORDING

This unit can make a tape deck's recording synchronized with CD play automatically. With this function, you can record a CD on tape very easily and more precisely.

This recording method needs a YAMAHA tape deck compatible with this function. (Refer to the tape deck's operation manual to know whether it is compatible or not.)

* This unit and the tape deck must be placed close to each other so that both of them can receive the signals from this unit's remote control transmitter at the same time.

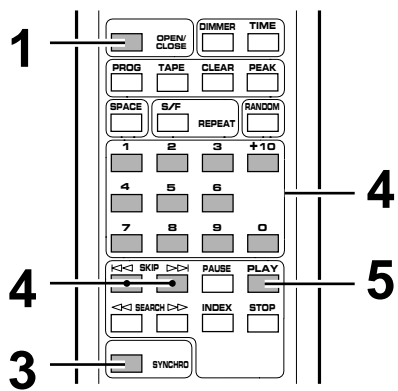

1 Load the disc.

2 Load a tape on the tape deck.
* The peak level search function of this unit is useful for adjusting recording level on the tape deck. (Refer to page 16.)

3

This unit enters into the pause mode, and the tape deck enters into the REC/PAUSE mode.
* In this mode, the time display on this unit flashes on and off.

4 If necessary, select a desired track.

5

Both CD play and tape deck recording begin.
* CD play begins a little later than recording.

6 If you want to stop recording temporarily and restart recording from a desired track, follow steps 3–5 again.

To cancel this function

Press the **STOP** button.

Notes

- To finish or stop the recording, make proper operations on the tape deck.
- Programmed sequence of tracks can also be recorded with this function, instead of recording an entire disc. (Refer to page 11–12 for the programming procedure.)
- This function can also be used together with the automatic tape-programming function. (Refer to page 13–15.)

NOTES ABOUT THE REMOTE CONTROL TRANSMITTER

Battery installation

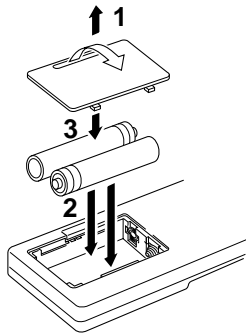

Battery replacement

If you find that the remote control transmitter must be used closer to the main unit, the batteries are weak. Replace both batteries with new ones.

Notes

- Use only AA, R6, UM-3 batteries for replacement.
- Be sure the polarities are correct. (See the illustration inside the battery compartment.)
- Remove the batteries if the remote control transmitter will not be used for an extended period of time.
- If batteries leak, dispose of them immediately. Avoid touching the leaked material or letting it come in contact with clothing, etc. Clean the battery compartment thoroughly before installing new batteries.

Remote control transmitter operation range

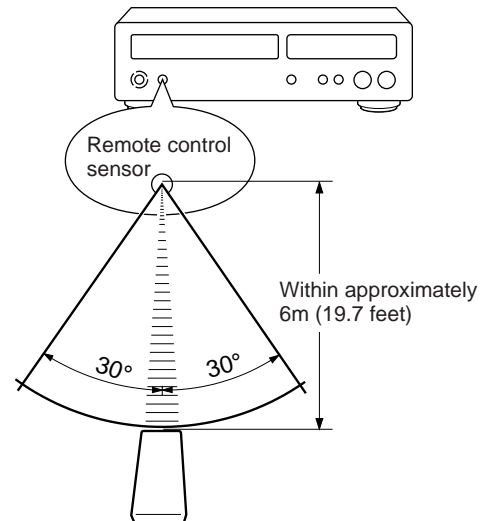

Notes

- There should be no large obstacles between the remote control transmitter and the main unit.
- If the remote control sensor is directly illuminated by strong lighting (especially an inverter type of fluorescent lamp etc.), it might cause the remote control transmitter not to work correctly. In this case, reposition the main unit to avoid direct lighting.

NOTES ABOUT HANDLING COMPACT DISCS

- This compact disc player is designed only for playing compact discs bearing the  mark. Never attempt to load any other type of disc into the unit. The unit will also play 8-cm (3-inch) compact discs.

- To remove a disc from its storage case, open the case and then press down at the center; with a finger through the center hole and the outer edges held as shown in the illustration, lift the disc out carefully.

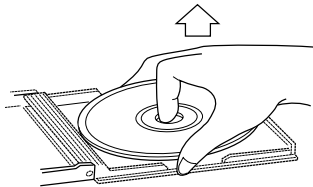

- Always handle the disc with care so that its surface is not scratched.

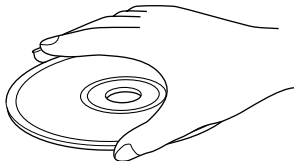

- Compact discs are not subjected to wear during play, but damage to the disc surface when the disc is being handled can adversely affect the disc's play.

- Compact discs are not affected by small particles of dust or fingerprints on their playing surface, but even so they should be kept clean. Wipe by using a clean, dry cloth. Do not wipe with a circular motion; wipe straight outward from the center.

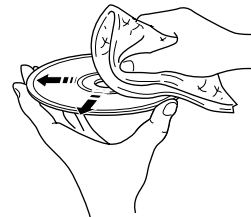

- Do not try to clean the disc's surface by using any type of disc cleaner, record spray, anti-static spray or liquid, or any other chemical-based liquid, because such substances might irreparably damage the disc's surface.
- Do not expose discs to direct sunlight, high temperature or high humidity for a long period of time, because these might warp or otherwise damage the disc.

No!



To play a 8-cm (3-inch) CD

Place it in the inner recessed area of the disc tray. Do not put a normal (12-cm/5-inch) CD on top of a 8-cm CD.

TROUBLESHOOTING

If the unit fails to operate normally, check the following points to determine whether the fault can be corrected by the simple measures suggested. If it cannot be corrected, or if the fault is not listed in the SYMPTOM column, disconnect the power cord and contact your authorized YAMAHA dealer or service center for help.

| SYMPTOM | PROBABLE CAUSE | REMEDY |
|---|--|--|
| The player does not switch ON when the POWER switch is pressed. | The power cord is not connected or not completely connected. | Securely connect the power cord. |
| The disc tray does not close completely. | A foreign object is obstructing the tray. | Carefully check the disc tray and remove the foreign object. |
| Play does not begin. | The disc is damaged. | Check the disc carefully; replace it if necessary. |
| | There is moisture on the laser pickup. | Wait 20 to 30 minutes after switching the unit ON before trying to play a disc. |
| | The disc has been loaded upside down. | Reload the disc with the label side up. |
| | The disc is dirty. | Clean the disc. |
| Play is delayed, or begins at the wrong place. | The disc may be scratched or damaged. | Check the disc carefully; replace it if necessary. |
| No sound. | Improper output cable connections. | Connect the cables properly. If the problem persists, the cables may be defective. |
| | Improper amplifier operation. | Set the amplifier controls to the correct input selection. |
| Sound "skips". | The player is being subjected to vibrations or impacts. | Relocate the player. |
| | The disc is dirty. | Clean the disc. |
| Sound "hums". | Improper cable connections. | Securely connect the audio cables. If the problem persists, the cables may be defective. |
| Noise from a nearby tuner. | The tuner is too close to the player. | Move the tuner and player farther apart. |
| Noise from inside of the disc tray. | The disc may be warped. | Replace the disc. |
| The remote control transmitter does not work. | The batteries of this remote control transmitter are too weak. | Replace the batteries with new ones. |
| | Direct sunlight or lighting (of an inverter type of fluorescent lamp etc.) is striking the remote control sensor of the main unit. | Change position of the main unit. |

SPECIFICATIONS

AUDIO SECTION

Frequency response 2 Hz – 20 kHz, ± 0.3 dB
 Harmonic distortion + noise 0.0022% (1 kHz)
 S/N ratio 118 dB
 Dynamic range 98 dB
 Wow & flutter Unmeasurable
 Output voltage 2.0 ± 0.5 V

GENERAL

Power requirements 120V, 60 Hz
 Power consumption 15W
 Dimensions (W x H x D) 280 x 82.5 x 354 mm
 (11" x 3-1/4" x 13-15/16")
 Weight 3.8 kg (8 lbs. 6 oz.)
 Accessories Connection cord
 Remote control transmitter
 Batteries (size AA, R6, UM-3)

Please note that all specifications are subject to change without notice.

YAMAHA

YAMAHA ELECTRONICS CORPORATION, USA 6660 ORANGETHORPE AVE., BUENA PARK, CALIF. 90620, U.S.A.
YAMAHA CANADA MUSIC LTD. 135 MILNER AVE., SCARBOROUGH, ONTARIO M1S 3R1, CANADA
YAMAHA ELECTRONIK EUROPA G.m.b.H. SIEMENSSTR. 22-34, D-25462 RELLINGEN BEI HAMBURG, F.R. OF GERMANY
YAMAHA ELECTRONIQUE FRANCE S.A. RUE AMBROISE CROIZAT BP70 CROISSY-BEAUBOURG 77312 MARNE-LA-VALLÉE CEDEX02, FRANCE
YAMAHA ELECTRONICS (UK) LTD. YAMAHA HOUSE, 200 RICKMANSWORTH ROAD WATFORD, HERTS WD1 7JS, ENGLAND
YAMAHA SCANDINAVIA A.B. J A WETTERGRENS GATA 1, BOX 30053, 400 43 VÄSTRA FRÖLUNDA, SWEDEN
YAMAHA MUSIC AUSTRALIA PTY, LTD. 17-33 MARKET ST., SOUTH MELBOURNE, 3205 VIC., AUSTRALIA

YAMAHA CORPORATION

0000000